



LED Display Product Data Sheet LTS-4801HG

Spec No.: DS-30-93-154

Effective Date: 04/19/2000

Revision: -

LITE-ON DCC

RELEASE

BNS-OD-FC001/A4

FEATURES

- * 0.39-INCH (10.0-mm) DIGIT HEIGHT.
- * CONTINUOUS UNIFORM SEGMENTS.
- * LOW POWER REQUIREMENT.
- * EXCELLENT CHARACTERS APPEARANCE.
- * HIGH BRIGHTNESS & HIGH CONTRAST.
- * WIDE VIEWING ANGLE.
- * SOLID STATE RELIABILITY.
- * CATEGORIZED FOR LUMINOUS INTENSITY.

DESCRIPTION

The LTS-4801HG is a 0.39-inch (10.0-mm) height single digit seven-segment display. This device utilizes green LED chips, which are made from GaP on GaP substrate, and has a gray face and white segments.

DEVICE

| PART NO. | DESCRIPTION |
|-------------------|-------------------------|
| GREEN | Common Anode |
| LTS-4801HG | Rt. Hand Decimal |

PACKAGE DIMENSIONS

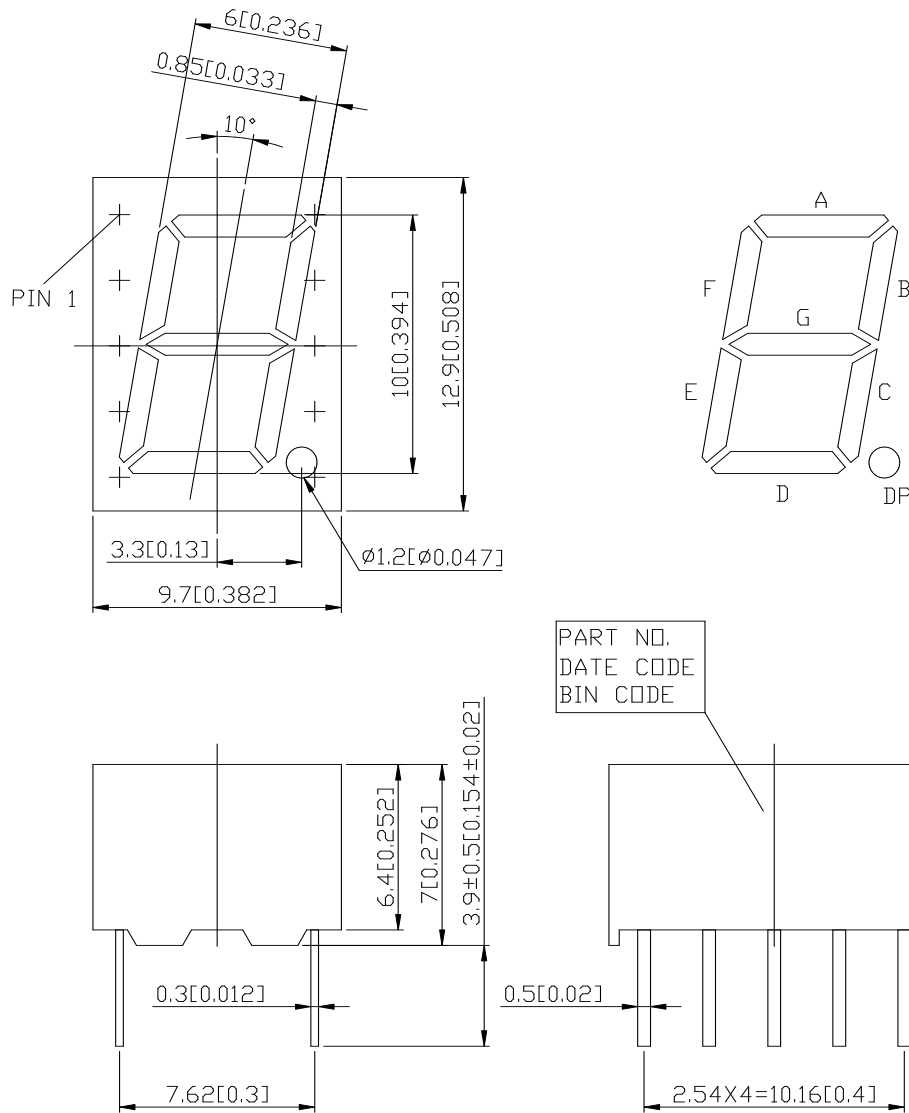

NOTES: All dimensions are in millimeters. Tolerance is ±0.25mm(0.01“) unless otherwise noted.

INTERNAL CIRCUIT DIAGRAM

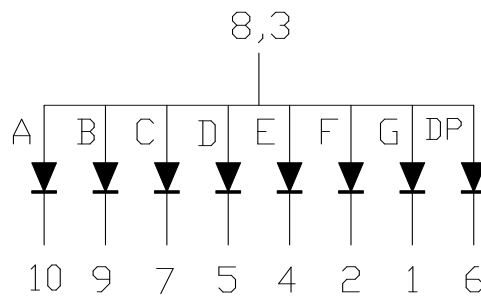

PIN CONNECTION

| No | CONNECTION |
|-----------|-------------------|
| 1 | CATHODE G |
| 2 | CATHODE F |
| 3 | COMMON ANODE |
| 4 | CATHODE E |
| 5 | CATHODE D |
| 6 | CATHODE D.P. |
| 7 | CATHODE C |
| 8 | COMMON ANODE |
| 9 | CATHODE B |
| 10 | CATHODE A |

NOTE: PIN 3 & 8 ARE INTERNALLY CONNECTED.

ABSOLUTE MAXIMUM RATING AT Ta=25°C

| PARAMETER | MAXIMUM RATING | UNIT |
|---|----------------|-------|
| Power Dissipation Per Segment | 75 | mW |
| Peak Forward Current Per Segment (1/10 Duty Cycle, 0.1ms Pulse Width) | 100 | mA |
| Continuous Forward Current Per Segment | 25 | mA |
| Derating Linear From 25°C Per Segment | 0.33 | mA/°C |
| Reverse Voltage Per Segment | 5 | V |
| Operating Temperature Range | -35°C to +85°C | |
| Storage Temperature Range | -35°C to +85°C | |
| Solder Temperature 1/16 inch Below Seating Plane for 3 Seconds at 260°C | | |

ELECTRICAL / OPTICAL CHARACTERISTICS AT Ta=25°C

| PARAMETER | SYMBOL | MIN. | TYP. | MAX. | UNIT | TEST CONDITION |
|-----------------------------------|-------------------|------|------|------|------|----------------------|
| Average Luminous Intensity | I _v | 1300 | 3100 | | μcd | I _F =10mA |
| Peak Emission Wavelength | λ _p | | 565 | | nm | I _F =20mA |
| Spectral Line Half-Width | Δλ | | 30 | | nm | I _F =20mA |
| Dominant Wavelength | λ _d | | 569 | | nm | I _F =20mA |
| Forward Voltage. Per Segment | V _F | | 2.0 | 2.6 | V | I _F =20mA |
| Reverse Current, Per Segment | I _R | | | 100 | μA | V _R =5V |
| Luminous Intensity Matching Ratio | I _v -m | | | 2:1 | | I _F =10mA |

Note: Luminous intensity is measured with a light sensor and filter combination that approximates the CIE (Commission Internationale De L'Eclairage) eye-response curve.

TYPICAL ELECTRICAL / OPTICAL CHARACTERISTIC CURVES

(25°C Ambient Temperature Unless Otherwise Noted)

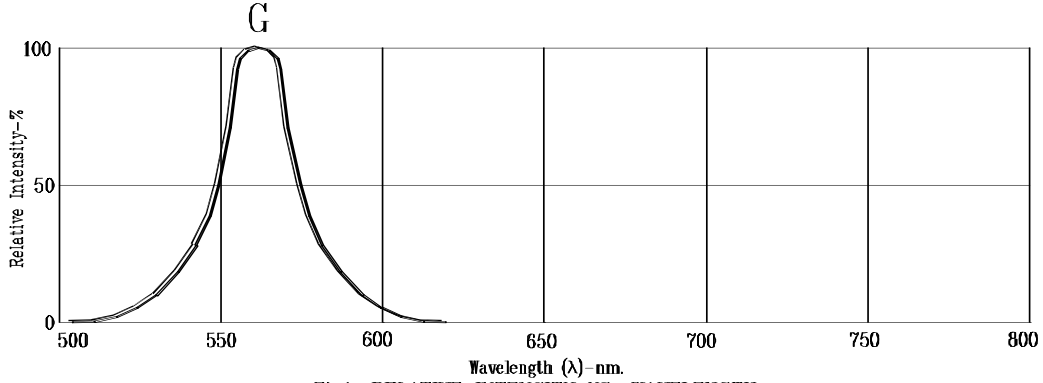

Fig1. RELATIVE INTENSITY VS. WAVELENGTH

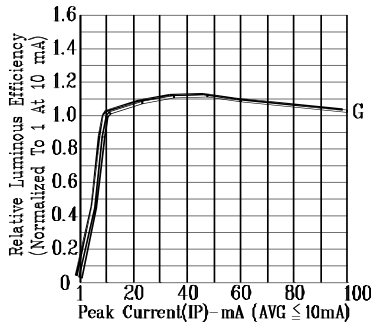

Fig2. RELATIVE LUMINOUS EFFICIENCY (LUMINOUS INTENSITY PER UNIT CURRENT) VS. PEAK CURRENT

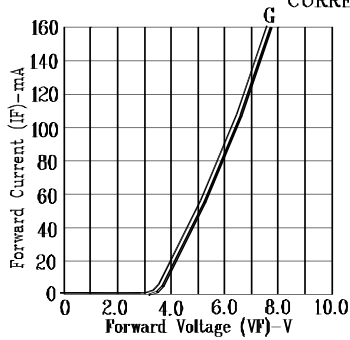

Fig3. FORWARD CURRENT VS. FORWARD VOLTAGE

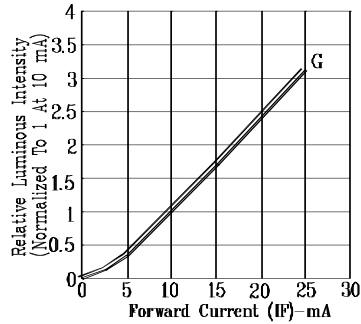

Fig4. RELATIVE LUMINOUS INTENSITY VS. FORWARD CURRENT

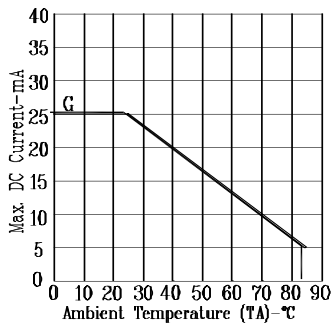

Fig5. MAX ALLOWABLE DC CURRENT VS. AMBIENT TEMPERATURE.

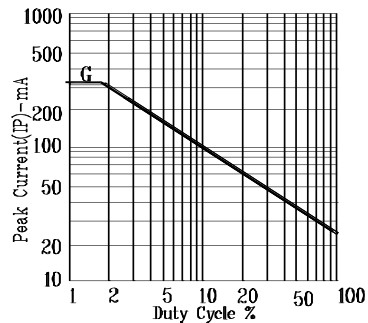

Fig6. MAX. PEAK CURRENT VS. DUTY CYCLE % (REFRESH RATE 1KHz)

NOTE : G=GREEN (REFRESH RATE 1KHz)