



# LED Display Product Data Sheet LTS-3401LE

Spec No.: DS-30-95-131

Effective Date: 03/29/2000

Revision: -

**LITE-ON DCC**

**RELEASE**

BNS-OD-FC001/A4

**FEATURES**

- \* 0.8 inch ( 20.32 mm) DIGIT HEIGHT.
- \* CONTINUOUS UNIFORM SEGMENTS.
- \* LOW POWER REQUIREMENT.
- \* EXCELLENT CHARACTERS APPEARANCE.
- \* HIGH BRIGHTNESS & HIGH CONTRAST.
- \* WIDE VIEWING ANGLE.
- \* SOLID STATE RELIABILITY.
- \* CATEGORIZED FOR LUMINOUS INTENSITY.

**DESCRIPTION**

The LTS-3401LE is a 0.8 inch (20.32 mm) digit height single digit seven-segment display. This device utilizes red orange LED chips, which are made from GaAsP on a transparent GaP substrate, and has a gray face and white segments.

**DEVICE**

<b>PART NO.</b>	<b>DESCRIPTION</b>
RED ORANGE	Common Anode
LTS-3401LE	Rt. & Lt. Hand Decimal

## PACKAGE DIMENSIONS

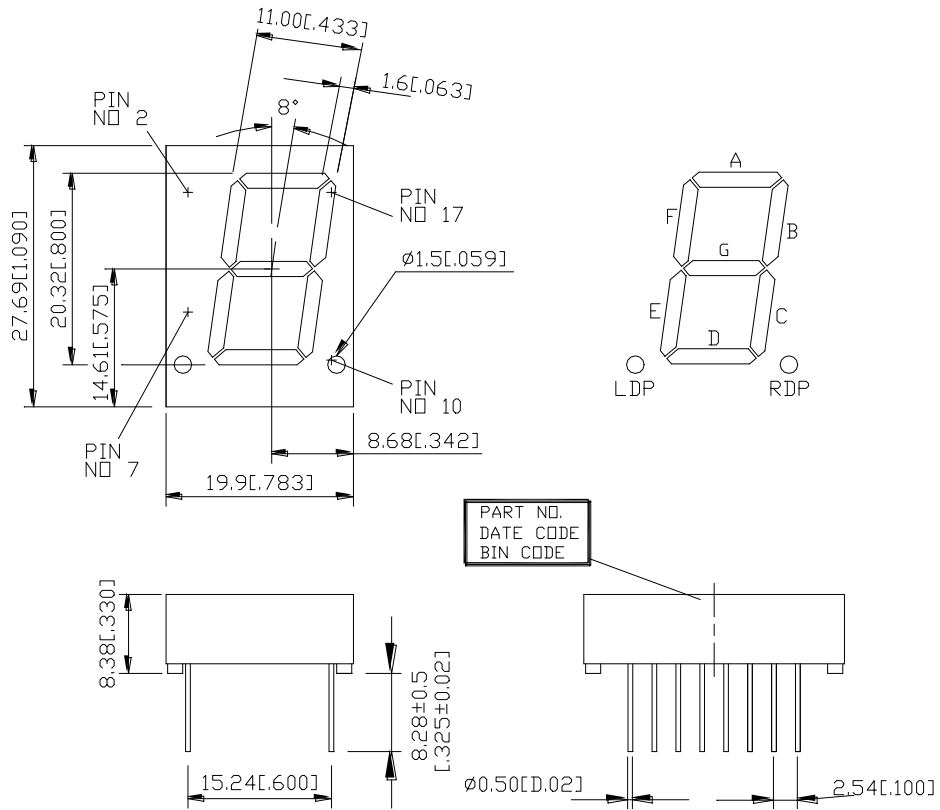

NOTES: All dimensions are in millimeters. Tolerance is  $\pm 0.25$  mm (0.01") unless otherwise noted.

## INTERNAL CIRCUIT DIAGRAM

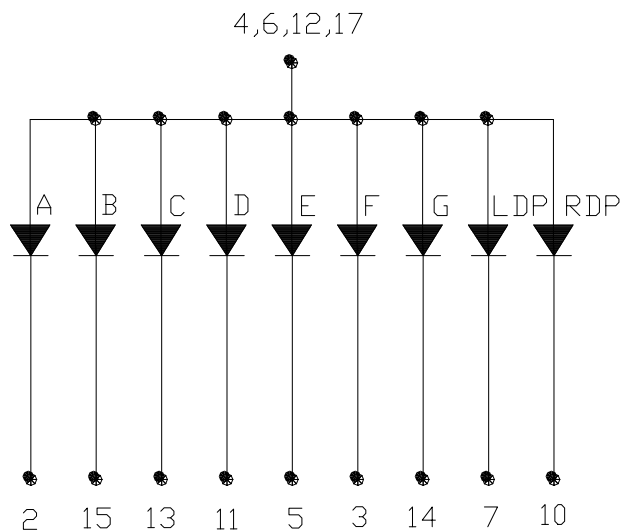

**PIN CONNECTION**

<b>No.</b>	<b>CONNECTION</b>
1	NO PIN
2	CATHODE A
3	CATHODE F
4	COMMON ANODE
5	CATHODE E
6	COMMON ANODE
7	CATHODE L.D.P
8	NO PIN
9	NO PIN
10	CATHODE R.D.P
11	CATHODE D
12	COMMON ANODE
13	CATHODE C
14	CATHODE G
15	CATHODE B
16	NO PIN
17	COMMON ANODE
18	NO PIN

**ABSOLUTE MAXIMUM RATING AT Ta=25°C**

PARAMETER	MAXIMUM RATING	UNIT
Power Dissipation Per Segment	75	mW
Peak Forward Current Per Segment ( 1/10 Duty Cycle, 0.1ms Pulse Width )	100	mA
Continuous Forward Current Per Segment	25	mA
Derating Linear From 25°C Per Segment	0.33	mA/°C
Reverse Voltage Per Segment	5	V
Operating Temperature Range	-35°C to +85°C	
Storage Temperature Range	-35°C to +85°C	
Solder Temperature: max 260°C for max 3sec at 1.6mm[1/16inch] below seating plane.		

**ELECTRICAL / OPTICAL CHARACTERISTICS AT Ta=25°C**

PARAMETER	SYMBOL	MIN.	TYP.	MAX.	UNIT	TEST CONDITION
Average Luminous Intensity	I <sub>v</sub>	800	2400		μcd	I <sub>F</sub> =10mA
Peak Emission Wavelength	λ <sub>p</sub>		630		nm	I <sub>F</sub> =20mA
Spectral Line Half-Width	Δλ		40		nm	I <sub>F</sub> =20mA
Dominant Wavelength	λ <sub>d</sub>		621		nm	I <sub>F</sub> =20mA
Forward Voltage Per Segment	V <sub>F</sub>		2.0	2.6	V	I <sub>F</sub> =20mA
Reverse Current Per Segment	I <sub>R</sub>			100	μA	V <sub>R</sub> =5V
Luminous Intensity Matching Ratio	I <sub>v</sub> -m			2:1		I <sub>F</sub> =10mA

Note: Luminous intensity is measured with a light sensor and filter combination that approximates the CIE (Commision Internationale De L'Eclairage) eye-response curve.

**TYPICAL ELECTRICAL / OPTICAL CHARACTERISTIC CURVES**

(25°C Ambient Temperature Unless Otherwise Noted)

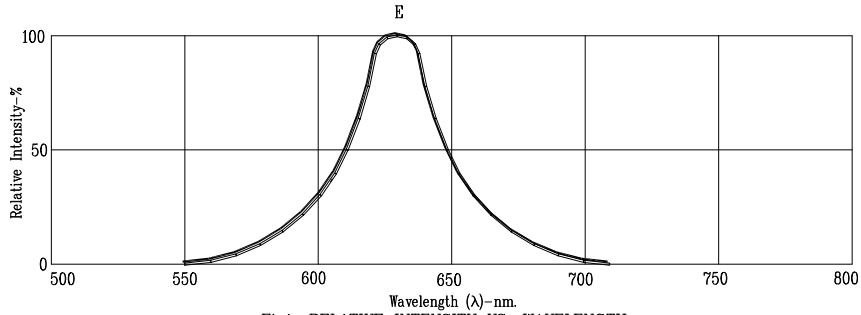

Fig1. RELATIVE INTENSITY VS. WAVELENGTH

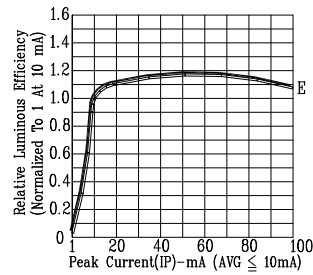

Fig2. RELATIVE LUMINOUS EFFICIENCY (LUMINOUS INTENSITY PER UNIT CURRENT) VS. PEAK CURRENT (REFRESH RATE 1KHz)

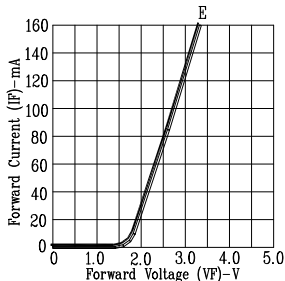

Fig3. FORWARD CURRENT VS. FORWARD VOLTAGE

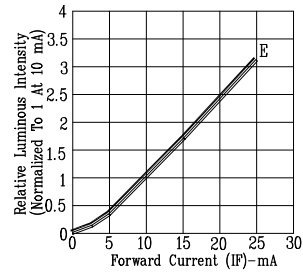

Fig4. RELATIVE LUMINOUS INTENSITY VS. FORWARD CURRENT

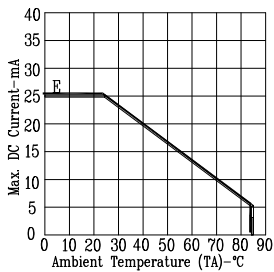

Fig5. MAX ALLOWABLE DC CURRENT VS. AMBIENT TEMPERATURE.

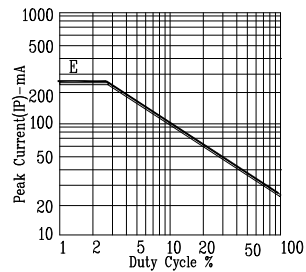

Fig6. MAX PEAK CURRENT VS. DUTY CYCLE % (REFRESH RATE 1KHz)

NOTE: E=RED ORANGE