



LED Display Product Data Sheet LTD-6410G

Spec No.: DS-30-97-034

Effective Date: 01/16/2010

Revision: B

LITE-ON DCC

RELEASE

BNS-OD-FC001/A4

FEATURES

- * 0.56 inch (14.22mm) DIGIT HEIGHT
- * CONTINUOUS UNIFORM SEGMENTS
- * LOW POWER REQUIREMENT
- * EXCELLENT CHARACTERS APPEARANCE
- * HIGH BRIGHTNESS & HIGH CONTRAST
- * WIDE VIEWING ANGLE
- * SOLID STATE RELIABILITY
- * CATEGORIZED FOR LUMINOUS INTENSITY
- * **LEAD-FREE PACKAGE (ACCORDING TO ROHS)**

DESCRIPTION

The LTD-6410G is a 0.56 inch (14.22mm) digit height dual digit seven-segment display. The device uses green LED chips(GaP epi on GaP substrate). The display has gray face and white segments.

DEVICE

PART NO.	DESCRIPTION
GREEN	COMMON ANODE RT. HAND DECIMAL
LTD-6410G	

PACKAGE DIMENSIONS

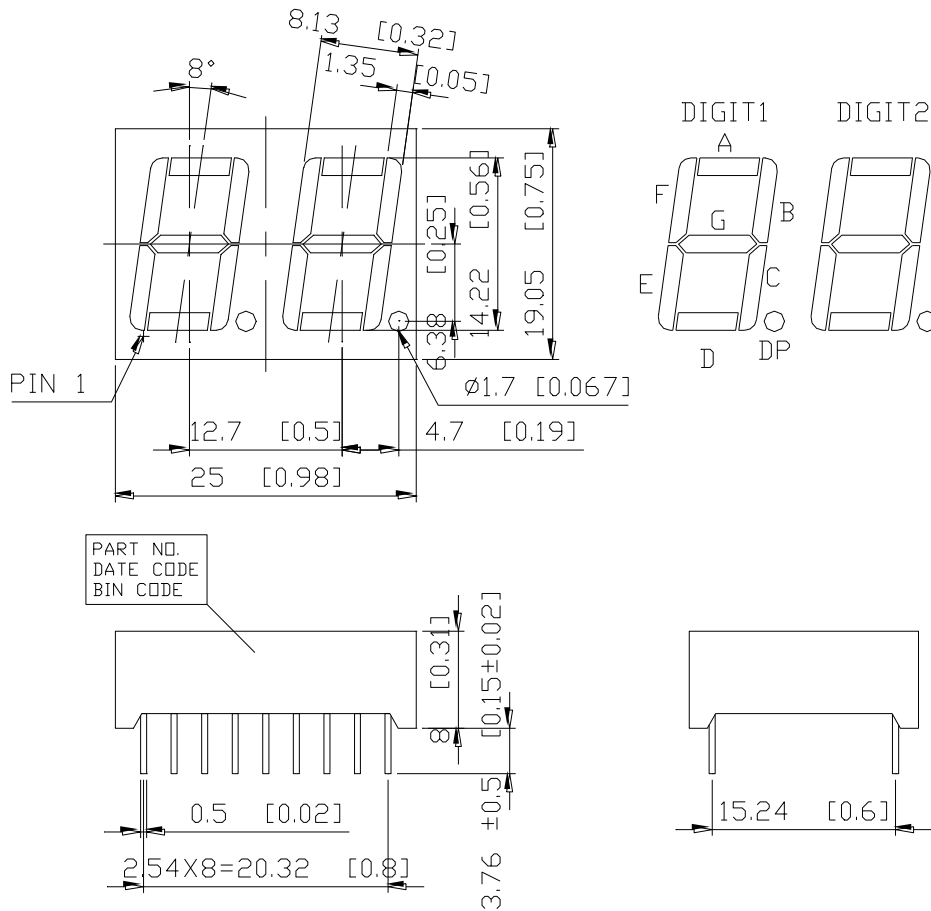

NOTES: All dimensions are in millimeters. Tolerances are ± 0.25 mm unless otherwise noted.

INTERNAL CIRCUIT DIAGRAM

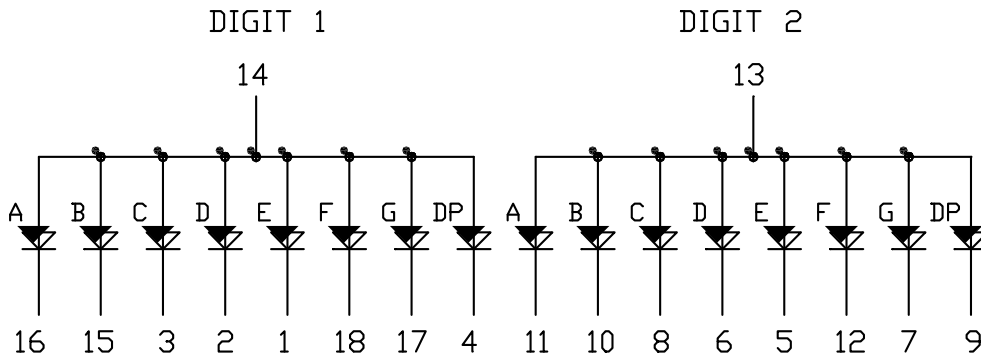

PIN CONNECTION

No.	CONNECTION
1	CATHODE E (DIGIT 1)
2	CATHODE D (DIGIT 1)
3	CATHODE C (DIGIT 1)
4	CATHODE DP (DIGIT 1)
5	CATHODE E (DIGIT 2)
6	CATHODE D (DIGIT 2)
7	CATHODE G (DIGIT 2)
8	CATHODE C (DIGIT 2)
9	CATHODE DP (DIGIT 2)
10	CATHODE B (DIGIT 2)
11	CATHODE A (DIGIT 2)
12	CATHODE F (DIGIT 2)
13	COMMON ANODE (DIGIT 2)
14	COMMON ANODE (DIGIT 1)
15	CATHODE B (DIGIT 1)
16	CATHODE A (DIGIT 1)
17	CATHODE G (DIGIT 1)
18	CATHODE F (DIGIT 1)

ABSOLUTE MAXIMUM RATING

PARAMETER	MAXIMUM RATING	UNIT
Power Dissipation Per Chip	75	mW
Peak Forward Current Per Chip (Frequency 1Khz, 10% duty cycle)	100*	mA
Continuous Forward Current Per Chip	25	mA
Forward Current Derating from 25 ⁰ C	0.33	mA/ ⁰ C
Reverse Voltage Per Chip	5	V
Operating Temperature Range	-35 ⁰ C to +85 ⁰ C	
Storage Temperature Range	-35 ⁰ C to +85 ⁰ C	
Soldering Conditions : 1/16 inch below seating plane for 3 seconds at 260 ⁰ C		

* see figure 5 to establish pulsed condition

TRICAL / OPTICAL CHARACTERISTICS AT T_A=25⁰C

PARAMETER	SYMBOL	MIN.	TYP.	MAX.	UNIT	TEST CONDITION
Average Luminous Intensity	I _v	870	2400		μcd	I _F =10mA
Peak Emission Wavelength	λ _p		565		nm	I _F =20mA
Spectral Line Half-Width	Δλ		30		nm	I _F =20mA
Dominant Wavelength	λ _d		569		nm	I _F =20mA
Forward Voltage Per Chip	V _F		2.1	2.6	V	I _F =20mA
Reverse Current Per Chip	I _R			100	μA	V _R =5V
Luminous Intensity Matching Ratio (Similar Light Area)	I _v -m			2:1		I _F =10mA

Note: Luminous intensity is measured with a light sensor and filter combination that approximates the CIE (Commision Internationale De L'Eclairage) eye-response curve.

TYPICAL ELECTRICAL / OPTICAL CHARACTERISTIC CURVES

(25°C Ambient Temperature Unless Otherwise Noted)

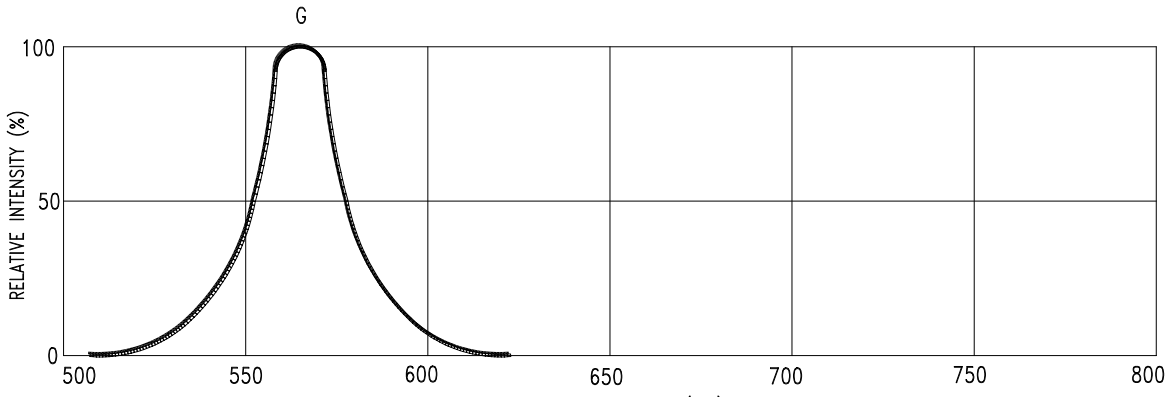

Fig1. Spectral Emission

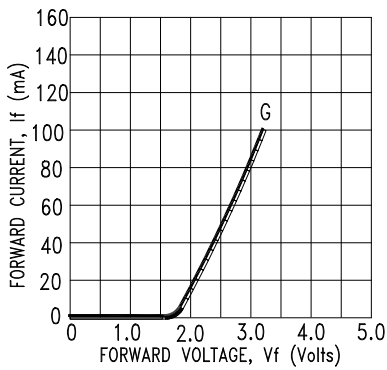

Fig2. Forward Current vs. Forward Voltage

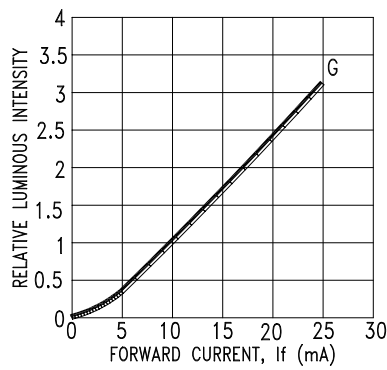

Fig3. Relative Luminous Intensity vs. DC Forward Current

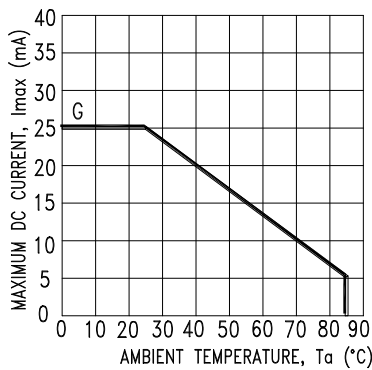

Fig4. Maximum Allowable DC Current vs. Ambient Temperature

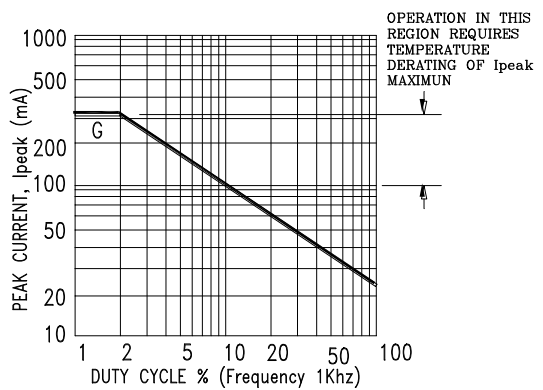

Fig5. Maximum Peak Current vs. Duty Cycle %

NOTE: G=GREEN.