



LED Display
Product Data Sheet
LTS-6980HR

Spec No. :DS-30-97-064
Effective Date: 06/03/2022
Revision: B

LITE-ON DCC

RELEASE

BNS-OD-FC001/A4

**LED DISPLAY
LTS-6980HR**

LED DISPLAY

LTS-6980HR

<u>Rev</u>	<u>Description</u>	<u>By</u>	<u>Date</u> DD/MM/YYYY
01	Preliminary SPEC	Amanda Lin	25/05/2000
Above data for PD and Customer tracking only			
-	Preliminary SPEC	Amanda Lin	25/05/2000
A	ADD Subcon GLD	CHUNCHUNLEE	15/01/2010
B	1.Add AllnGaP dice in description at page 2 2.Update note 2 of Electrical/Optical Characteristics at page 5 3.Correct typical Electrical/Optical Characteristics Curves at page 6	William Lin	31/03/2022

LED DISPLAY LTS-6980HR

1. Description

The LTS-6980HR is a 0.56 inch (14.22 mm) height digit displays. This high efficiency red device utilizes LED chips, (GaP epi on GaP substrate / AlInGaP on a non-transparent GaAs substrate) and has red face and red segments.

1.1 Features

- * 0.56 inch (14.22 mm) DIGIT HEIGHT.
- * CONTINUOUS UNIFORM SEGMENTS.
- * LOW POWER REQUIREMENT.
- * EXCELLENT CHARACTERS APPEARANCE.
- * HIGH BRIGHTNESS & HIGH CONTRAST.
- * WIDE VIEWING ANGLE.
- * SOLID STATE RELIABILITY.
- * CATEGORIZED FOR LUMINOUS INTENSITY.
- * LEAD-FREE PACKAGE (ACCORDING TO ROHS).

1.2 Device

Part No	Description
RED ORANGE	COMMON CATHODE RT. HAND DECIMAL
LTS-6980HR	

**LED DISPLAY
LTS-6980HR**

2. Package Dimensions

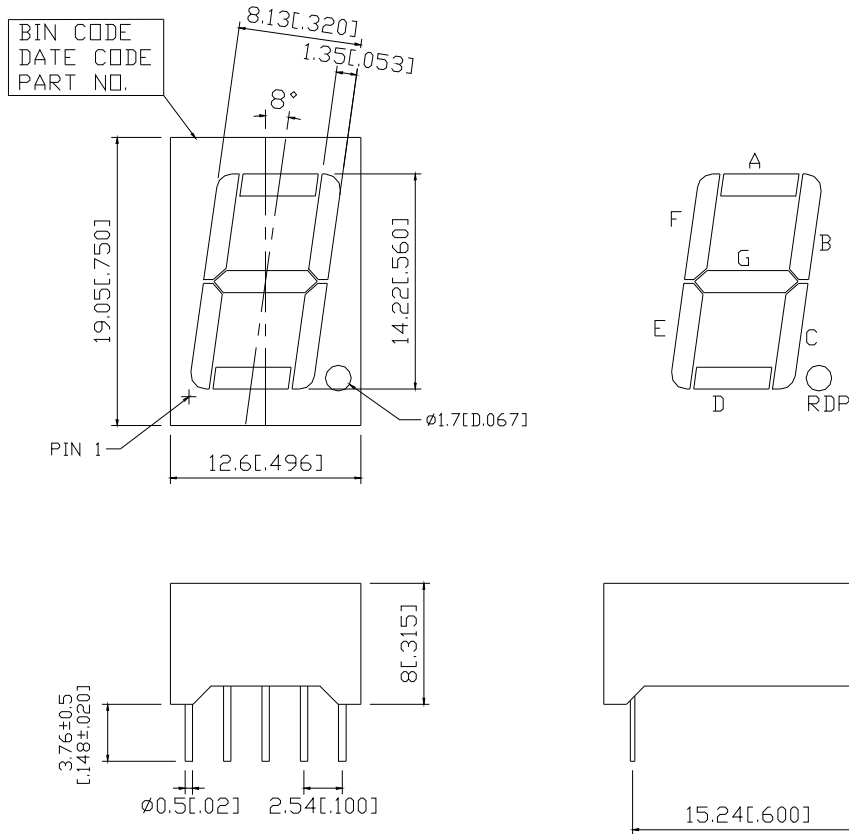

Note:

1. All dimensions are in millimeters. Tolerances are ± 0.25 mm (0.01 ") unless otherwise noted.

**LED DISPLAY
LTS-6980HR**

3. Internal Circuit Diagram

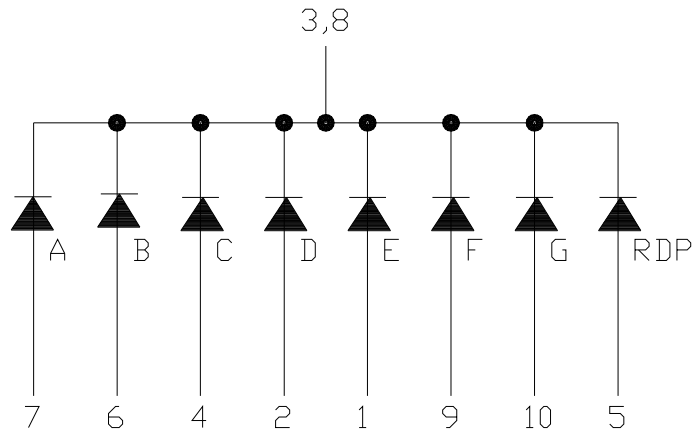

4. Pin Connection

No.	CONNECTION
1	ANODE E
2	ANODE D
3	COMMON CATHODE
4	ANODE C
5	ANODE R.D.P.
6	ANODE B
7	ANODE A
8	COMMON CATHODE
9	ANODE F
10	ANODE G

LED DISPLAY LTS-6980HR

5. Rating and Characteristics

5.1. Absolute Maximum Rating at Ta=25°C

Parameter	Maximum Rating	Unit
Power Dissipation Per Segment	75	mW
Peak Forward Current Per Segment (1/10 Duty Cycle, 0.1ms Pulse Width)	100	mA
Continuous Forward Current Per Segment	25	mA
Derating Linear From 25°C Per Segment	0.33	mA/°C
Reverse Voltage Per Segment	5	V
Operating Temperature Range	-35°C to +85°C	
Storage Temperature Range	-35°C to +85°C	
Solder Temperature: max 260°C for max 3sec at 1.6mm[1/16inch] below seating plane.		

5.2. Electrical / Optical Characteristics at Ta=25°C

Parameter	Symbol	MIN.	TYP.	MAX.	Unit	Test Condition
Average Luminous Intensity	IV	800	2400		μcd	IF = 10mA
Peak Emission Wavelength	λp		635		nm	IF = 20mA
Spectral Line Half-Width	Δλ		40		nm	IF = 20mA
Dominant Wavelength	λd		623		nm	IF = 20mA
Forward Voltage Per Segment	VF		2.0	2.6	V	IF = 20mA
Reverse Current Per Segment	IR			100	μA	VR = 5V
Luminous Intensity Matching Ratio	IV-m			2:1		IF = 10mA

Note:

- Luminous intensity is measured with a light sensor and filter combination that approximates the CIE (Commision Internationale De L'Eclairage) eye-response curve.
- Reverse voltage is only for IR test, it cannot continue to operate this situation.

LED DISPLAY LTS-6980HR

5.3. Typical Electrical / Optical Characteristics Curves

(25°C Ambient Temperature Unless Otherwise Noted)

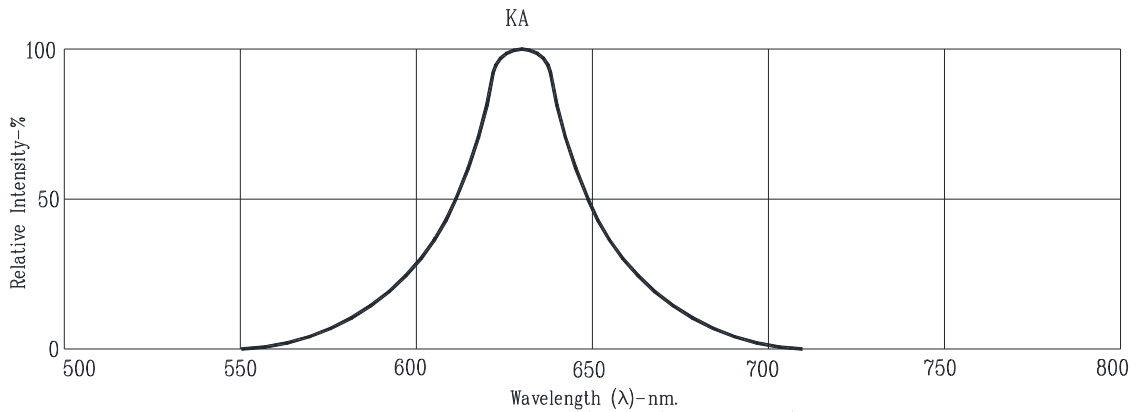

Fig1. RELATIVE INTENSITY VS. WAVELENGTH

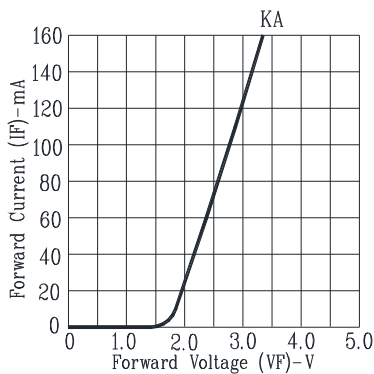

Fig2. FORWARD CURRENT VS. FORWARD VOLTAGE

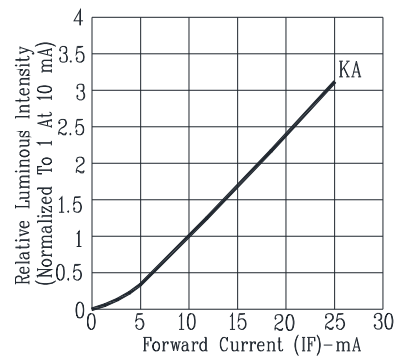

Fig3. RELATIVE LUMINOUS INTENSITY VS. FORWARD CURRENT

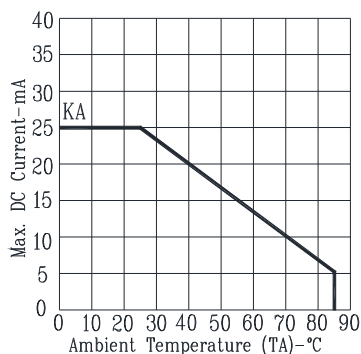

Fig4. MAX. ALLOWABLE DC CURRENT VS. AMBIENT TEMPERATURE.

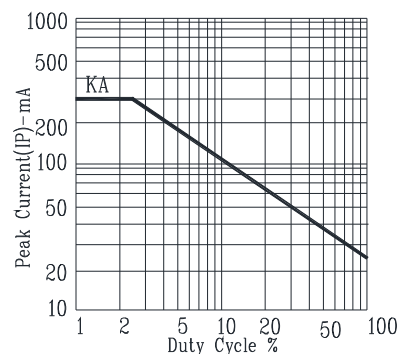

Fig5. MAX. PEAK CURRENT VS. DUTY CYCLE % (REFRESH RATE 1KHz)