



# LED Display Product Data Sheet LTD-5632HG

Spec No.: DS-30-97-094

Effective Date: 08/26/2009

Revision: D

**LITE-ON DCC**

**RELEASE**

BNS-OD-FC001/A4

## **FEATURES**

- \* 0.56 inch (14.2 mm ) DIGIT HEIGHT
- \* EXCELLENT SEGMENT UNIFORMITY
- \* LOW POWER REQUIREMENT
- \* HIGH BRIGHTNESS AND HIGH CONTRAST
- \* WIDE VIEWING ANGLE
- \* SOLID STATE RELIABILITY
- \* BINNED FOR LUMINOUS INTENSITY

## **DESCRIPTION**

The LTD-5632HG is a 0.5 inch (12.7 mm) digit height dual-digit display. This device uses HI.-EFF. GREEN LED chips (GaP epi on GaP substrate). The display has a black face and white segments.

## **DEVICE**

<b>PART NO.</b>	<b>DESCRIPTION</b>
HI.-EFF. GREEN	Duplex Common Anode
LTD-5632HG	

## PACKAGE DIMENSIONS

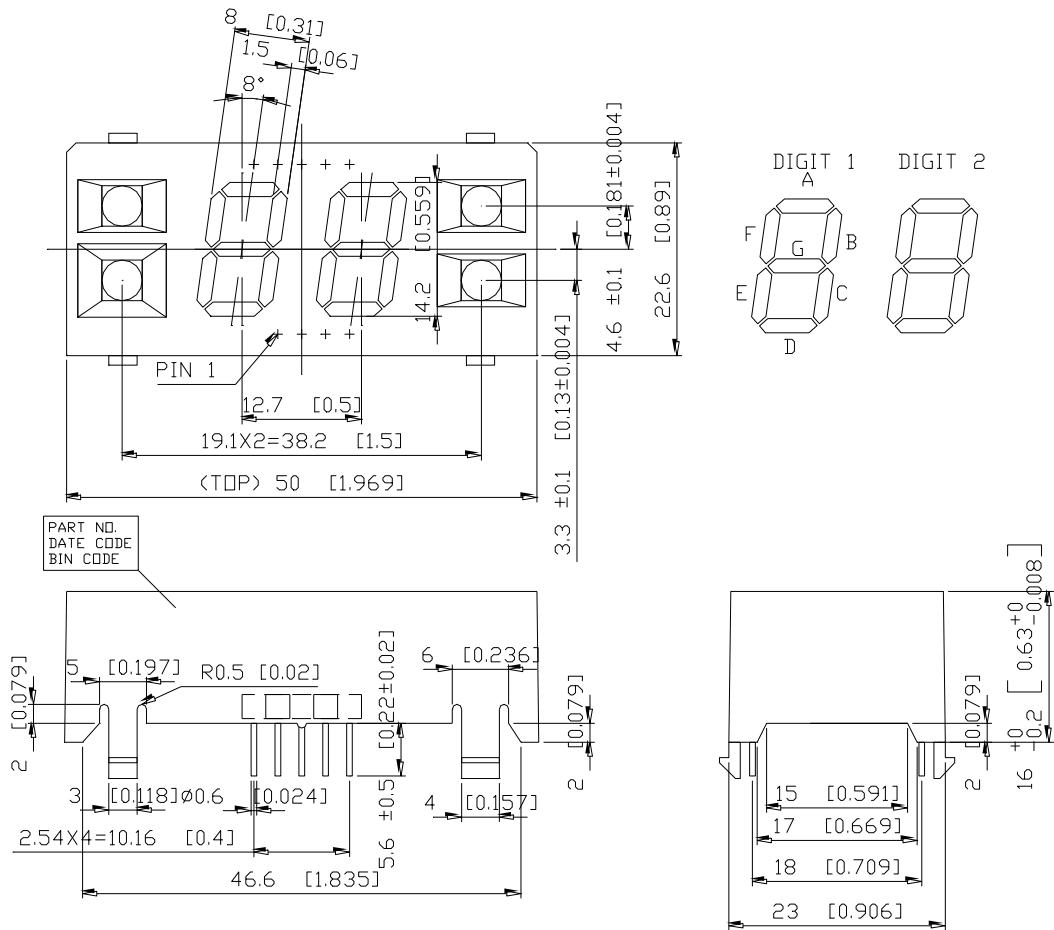

NOTES: All dimensions are in millimeters. Tolerances are  $\pm 0.25\text{mm}$  (0.01") unless otherwise noted.

## INTERNAL CIRCUIT DIAGRAM

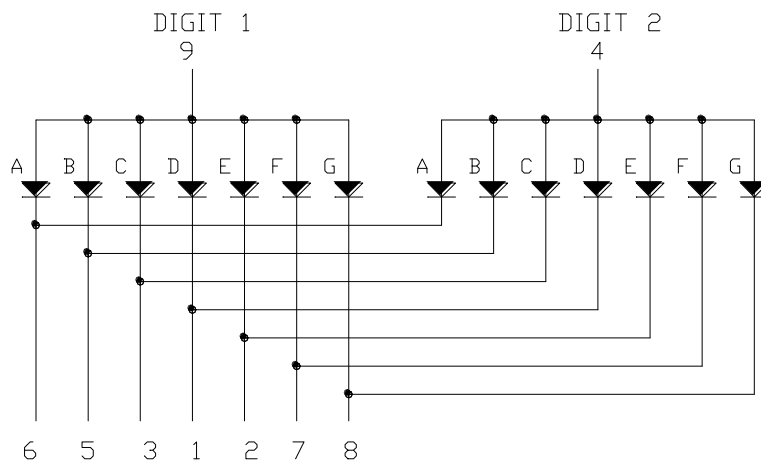

**PIN CONNECTION**

<b>No</b>	<b>CONNECTION</b>
1	Cathode D
2	Cathode E
3	Cathode C
4	Common Anode (Digit 2)
5	Cathode B
6	Cathode A
7	Cathode F
8	Cathode G
9	Common Anode (Digit 1)

## ABSOLUTE MAXIMUM RATING

PARAMETER	MAXIMUM RATING	UNIT
Power Dissipation Per Segment	75	mW
Peak Forward Current Per Segment ( Frequency 1Khz, 10% duty cycle)	100*	mA
Continuous Forward Current Per Segment	25	mA
Forward Current Derating from 25 <sup>0</sup> C	0.33	mA/ <sup>0</sup> C
Reverse Voltage Per Segment	5	V
Operating Temperature Range	-35 <sup>0</sup> C to +85 <sup>0</sup> C	
Storage Temperature Range	-35 <sup>0</sup> C to +85 <sup>0</sup> C	
Soldering Conditions : 1/16 inch below seating plane for 3 seconds at 260 <sup>0</sup> C		

\* see figure 5 to establish pulsed condition

## ELECTRICAL / OPTICAL CHARACTERISTICS AT Ta=25<sup>0</sup>C

PARAMETER	SYMBOL	MIN	TYP	MAX	UNIT	TEST CONDITION
Average Luminous Intensity Per Segment	I <sub>v</sub>	1300	3200		μcd	I <sub>F</sub> = 10mA
Peak Emission Wavelength	λ <sub>p</sub>		565		nm	I <sub>F</sub> = 20mA
Spectral Line Half-Width	Δλ		30		nm	I <sub>F</sub> = 20mA
Dominant Wavelength	λ <sub>d</sub>		569		nm	I <sub>F</sub> = 20mA
Forward Voltage Per Segment	V <sub>F</sub>		2.1	2.6	V	I <sub>F</sub> = 20mA
Reverse Current Per Segment	I <sub>R</sub>			100	μA	V <sub>R</sub> = 5V
Luminous Intensity Matching Ratio	I <sub>v</sub> -m			2 : 1		I <sub>F</sub> = 10mA

Note: Luminous Intensity is measured with a light sensor and filter combination that approximates the CIE (Commision Internationale De L'Eclairage) eye-response curve.

## TYPICAL ELECTRICAL / OPTICAL CHARACTERISTIC CURVES

(25°C Ambient Temperature Unless Otherwise Noted)

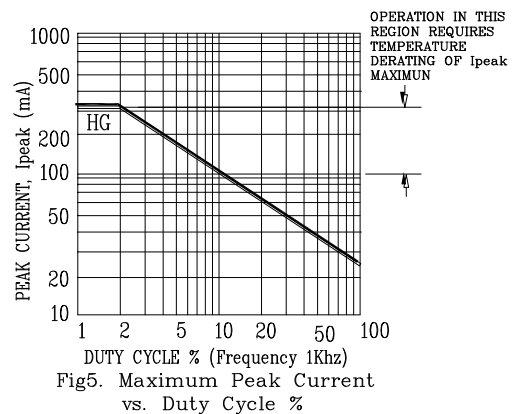
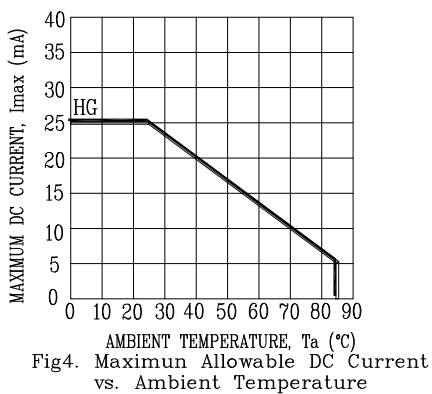
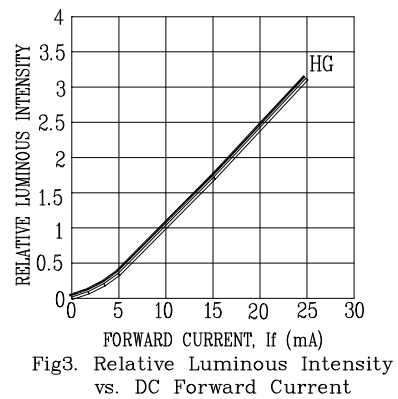
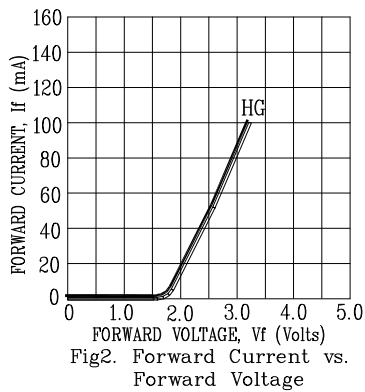
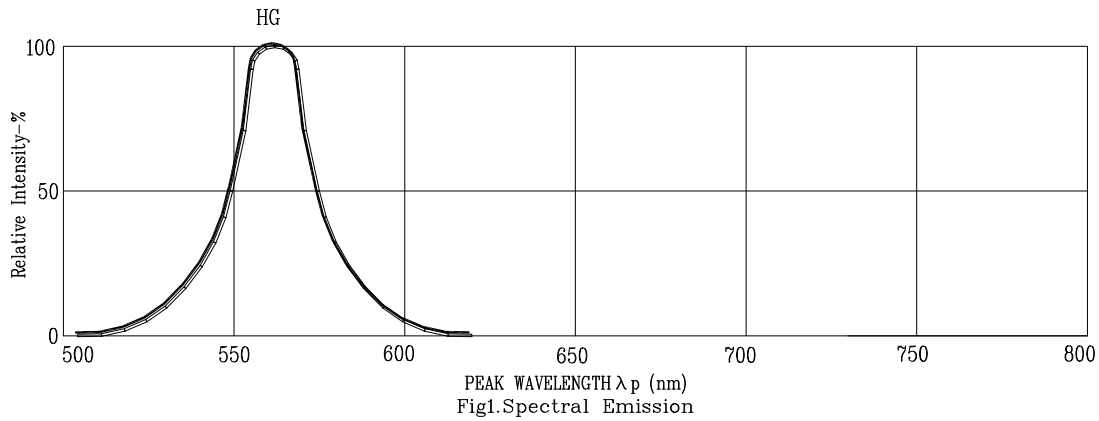

NOTE: HG=HI-EFF. GREEN