



# LED Display Product Data Sheet LTS-3403VE

Spec No.: DS-30-98-017

Effective Date: 03/31/2000

Revision: -

**LITE-ON DCC**

**RELEASE**

BNS-OD-FC001/A4

## **FEATURES**

- \* 0.8-INCH (20.32-mm) DIGIT HEIGHT.
- \* CONTINUOUS UNIFORM SEGMENTS.
- \* LOW POWER REQUIREMENT.
- \* EXCELLENT CHARACTERS APPEARANCE.
- \* HIGH BRIGHTNESS & HIGH CONTRAST.
- \* WIDE VIEWING ANGLE.
- \* SOLID STATE RELIABILITY.
- \* CATEGORIZED FOR LUMINOUS INTENSITY.

## **DESCRIPTION**

The LTS-3403VE is a 0.8-inch (20.32-mm) height single digit display. This device utilizes red orange LED chips, which are made from GaAsP on a GaP substrate, and has a gray face and white segments.

## **DEVICE**

<b>PART NO.</b>	<b>DESCRIPTION</b>
RED ORANGE	Common Cathode, Rt. & Lt. Hand decimal
LTS-3403VE	

## PACKAGE DIMENSIONS

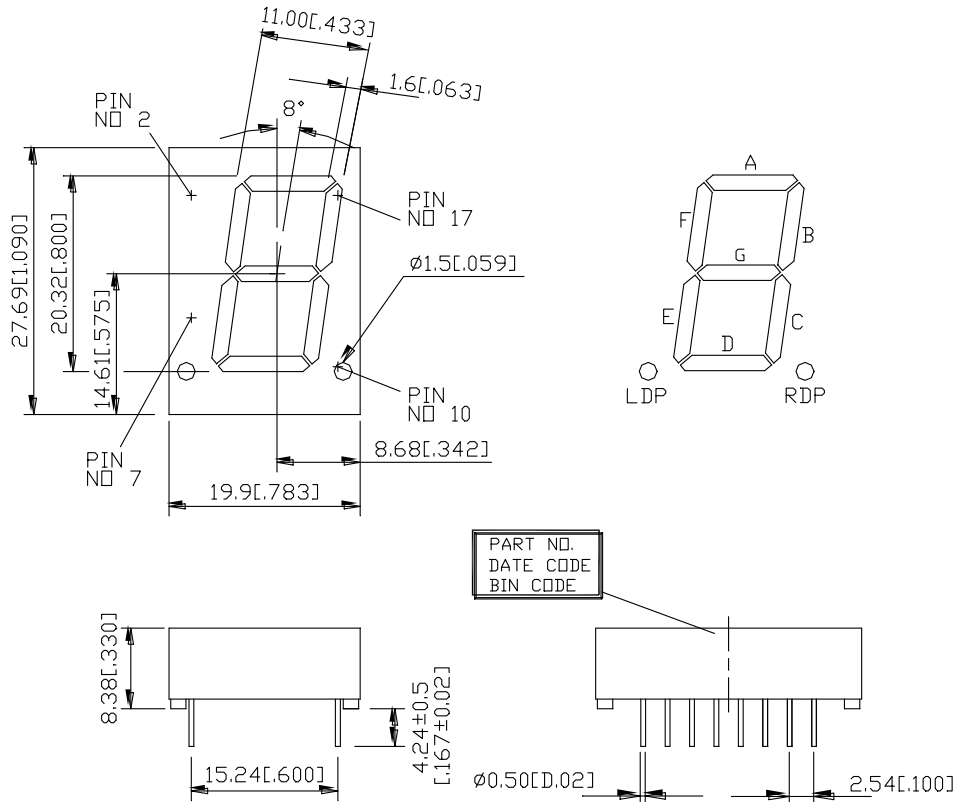

NOTES: All dimensions are in millimeters. Tolerance is  $\pm 0.25$ -mm (0.01") unless otherwise noted.

## INTERNAL CIRCUIT DIAGRAM

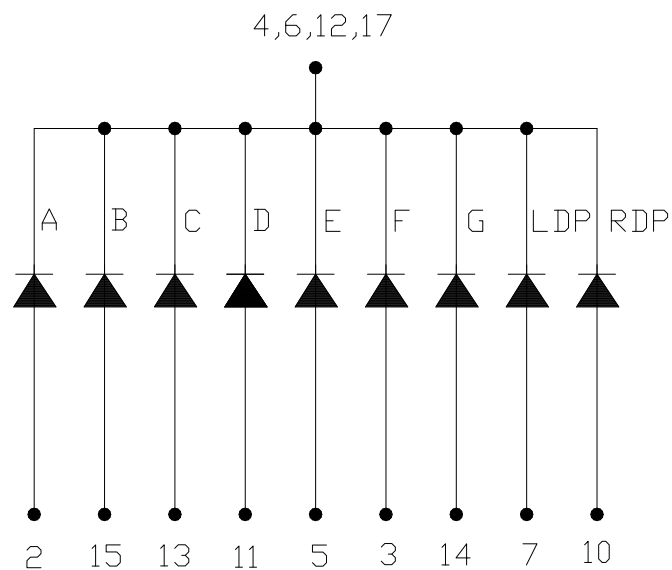

**PIN CONNECTION**

<b>No.</b>	<b>CONNECTION</b>
1	NO PIN
2	ANODE A
3	ANODE F
4	COMMON CATHODE *1
5	ANODE E
6	COMMON CATHODE *1
7	ANODE L.D.P
8	NO PIN
9	NO PIN
10	ANODE R.D.P
11	ANODE D
12	COMMON CATHODE *1
13	ANODE C
14	ANODE G
15	ANODE B
16	NO PIN
17	COMMON CATHODE *1
18	NO PIN

NOTE: \*1 Pin 4,6,12, & 17 are internally connected.

**ABSOLUTE MAXIMUM RATING AT T<sub>A</sub>=25°C**

PARAMETER	MAXIMUM RATING	UNIT
Power Dissipation Per Segment	75	mW
Peak Forward Current Per Segment ( 1/10 Duty Cycle, 0.1ms Pulse Width )	100	mA
Continuous Forward Current Per Segment Derating Linear From 25°C Per Segment	25 0.33	mA mA/°C
Reverse Voltage Per Segment	5	V
Operating Temperature Range	-35°C to +85°C	
Storage Temperature Range	-35°C to +85°C	
Solder Temperature 1/16 inch Below Seating Plane for 3 Seconds at 260°C		

**ELECTRICAL / OPTICAL CHARACTERISTICS AT T<sub>A</sub>=25°C**

PARAMETER	SYMBOL	MIN.	TYP.	MAX.	UNIT	TEST CONDITION
Average Luminous Intensity	I <sub>v</sub>	800	2400		μcd	I <sub>F</sub> =10mA
Peak Emission Wavelength	λ <sub>p</sub>		630		nm	I <sub>F</sub> =20mA
Spectral Line Half-Width	Δλ		40		nm	I <sub>F</sub> =20mA
Dominant Wavelength	λ <sub>d</sub>		621		nm	I <sub>F</sub> =20mA
Forward Voltage. Per Segment	V <sub>F</sub>		2.0	2.6	V	I <sub>F</sub> =20mA
Reverse Current, Per Segment	I <sub>R</sub>			100	μA	V <sub>R</sub> =5V
Luminous Intensity Matching Ratio	I <sub>v</sub> -m			2:1		I <sub>F</sub> =10mA

Note: Luminous intensity is measured with a light sensor and filter combination that approximates the CIE (Commission Internationale De L'Eclairage) eye-response curve.

## TYPICAL ELECTRICAL / OPTICAL CHARACTERISTIC CURVES

(25°C Ambient Temperature Unless Otherwise Noted)

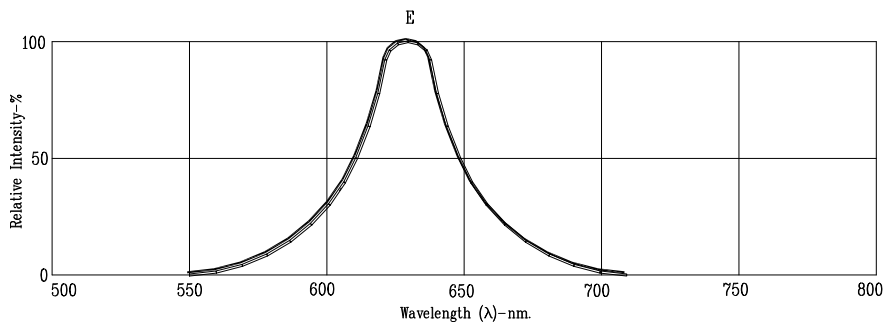

Fig1. RELATIVE INTENSITY VS. WAVELENGTH

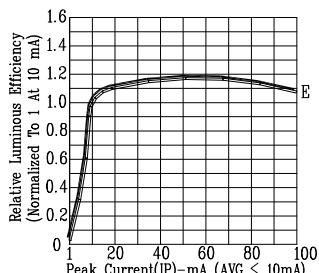

Fig2. RELATIVE LUMINOUS EFFICIENCY (LUMINOUS INTENSITY PER UNIT CURRENT) VS. PEAK CURRENT (REFRESH RATE 1KHz)

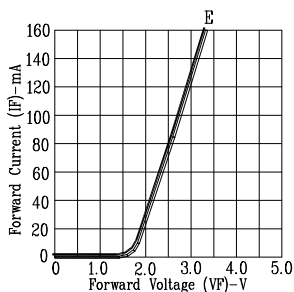

Fig3. FORWARD CURRENT VS. FORWARD VOLTAGE

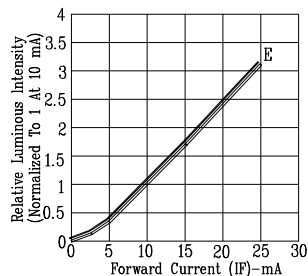

Fig4. RELATIVE LUMINOUS INTENSITY VS. FORWARD CURRENT

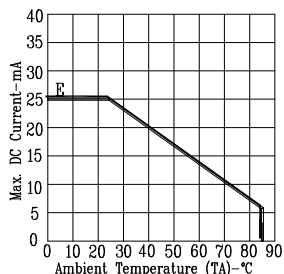

Fig5. MAX. ALLOWABLE DC CURRENT VS. AMBIENT TEMPERATURE.

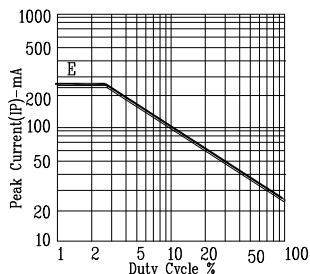

Fig6. MAX. PEAK CURRENT VS. DUTY CYCLE % (REFRESH RATE 1KHz)

NOTE: E=RED ORANGE