



# Photointerrupter Product Data Sheet LTH-306-09S

Spec No.: DS-55-99-0011

Effective Date: 05/23/2000

Revision: -

**LITE-ON DCC**

**RELEASE**

BNS-OD-FC001/A4

# LITEON LITE-ON TECHNOLOGY CORPORATION

Property of LITE-ON Only

## FEATURES

- \* MECHANICAL SWITCH REPLACEMENT.
- \* CUSTOMIZED LEVER ARM CAN BE DESIGNED FOR SPECIFIC APPLICATION.

## PACKAGE DIMENSIONS

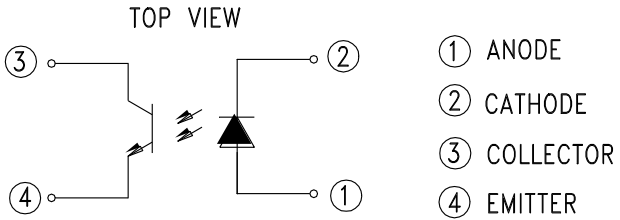
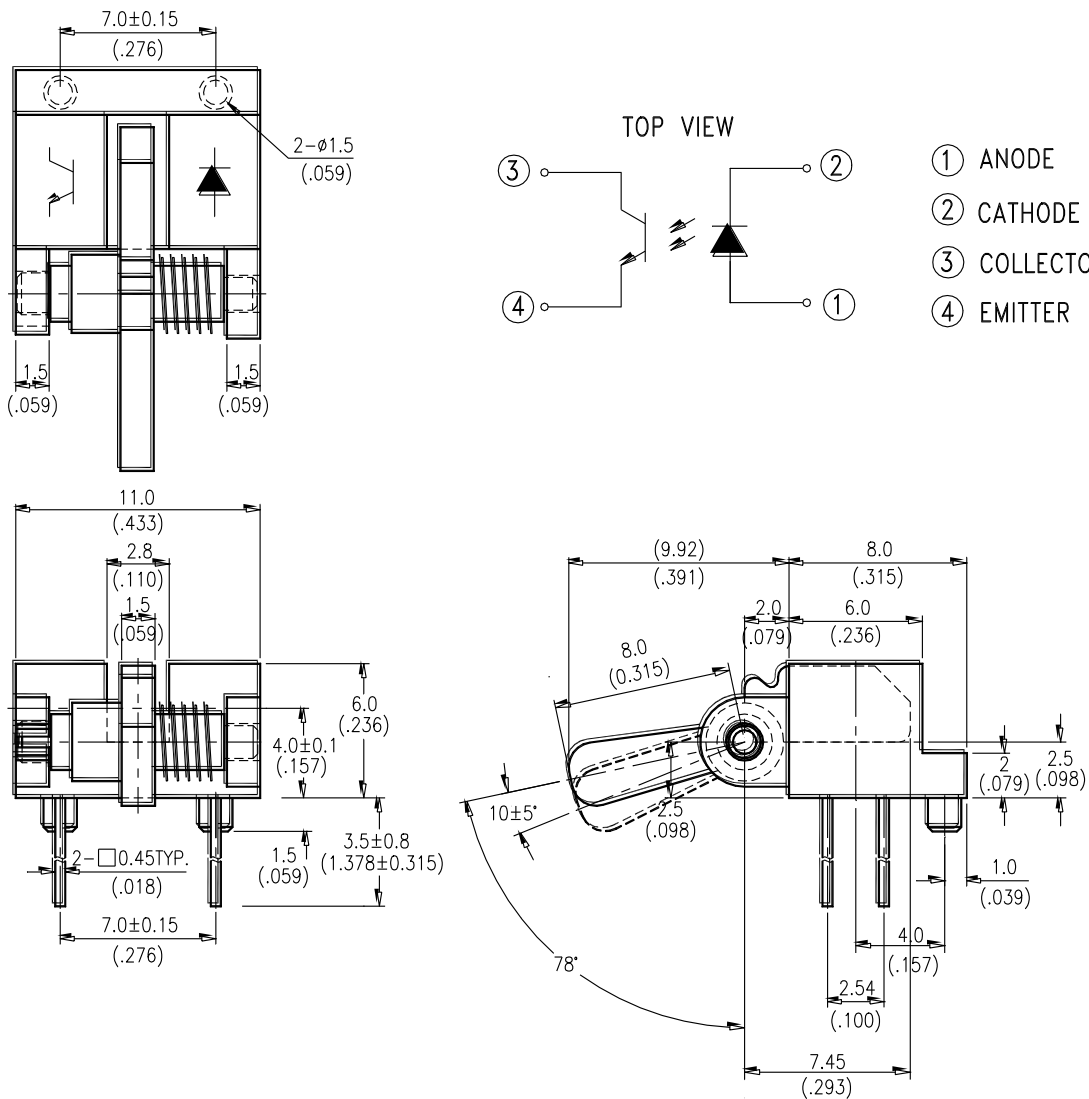

## NOTES:

1. All dimensions are in millimeters (inches).
2. Tolerance is  $\pm 0.25\text{mm}(.010\text{'})$  unless otherwise noted.

## ABSOLUTE MAXIMUM RATINGS AT TA=25°C

PARAMETER	MAXIMUM RATING	UNIT
INPUT LED		
Power Dissipation	75	mW
Peak Forward Current ( 300 pps , 10 $\mu$ S pulse)	1	A
Continuous Forward Current	50	mA
Reverse Voltage	5	V
OUTPUT PHOTOTRANSISTOR		
Power Dissipation	100	mW
Collector-Emitter Voltage	30	V
Emitter-Collector Voltage	5	V
Collector Current	20	mA
Operating Temperature Range	-25°C to + 85°C	
Storage Temperature Range	-40°C to + 100°C	
Lead Soldering Temperature [ 1.6mm (.063") Form Case ]	260°C for 5 Seconds	

## ELECTRICAL OPTICAL CHARACTERISTICS AT TA=25°C

PARAMETER	SYMBOL	MIN.	TYP.	MAX.	UNIT	TEST CONDITION
INPUT LED						
Forward Voltage	$V_F$		1.2	1.6	V	$I_F = 20\text{mA}$
Reverse Current	$I_R$			100	$\mu\text{A}$	$V_R = 5\text{V}$
OUTPUT PHOTOTRANSISTOR						
Collector-Emitter Dark Current	$I_{CEO}$			100	nA	$V_{CE} = 10\text{V}$
COUPLER						
Collector-Emitter Saturation Voltage	$V_{CE(SAT)}$			0.4	V	$I_C = 0.25\text{mA}$ $I_F = 20\text{mA}$
On State Collector Current	$I_{C(ON)}$	0.5			mA	$V_{CE} = 5\text{V}$ $I_F = 20\text{mA}$
Action Angle		8		14	DEG	$V_{CE} = 5\text{V}$ $I_F = 20\text{mA}$

## TYPICAL ELECTRICAL / OPTICAL CHARACTERISTICS CURVES

(25°C Ambient Temperature Unless Otherwise Noted)

Fig.1 Power Dissipation vs. Ambient Temperature

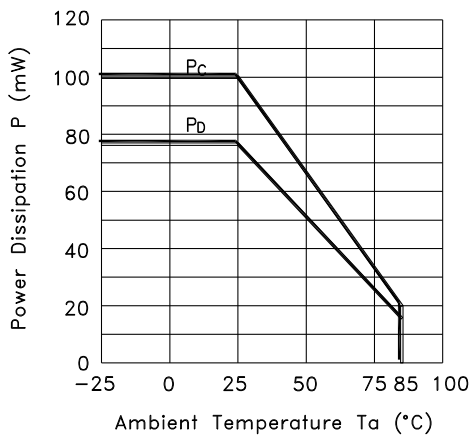

Fig.2 Forward Current vs. Forward Voltage

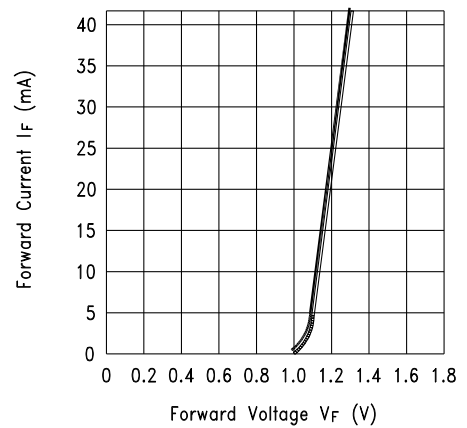

Fig.3 Collector Current vs. Forward Voltage

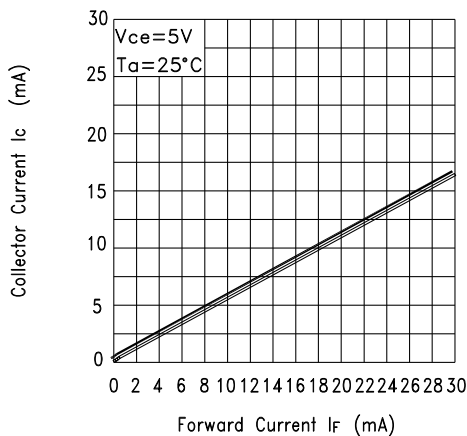
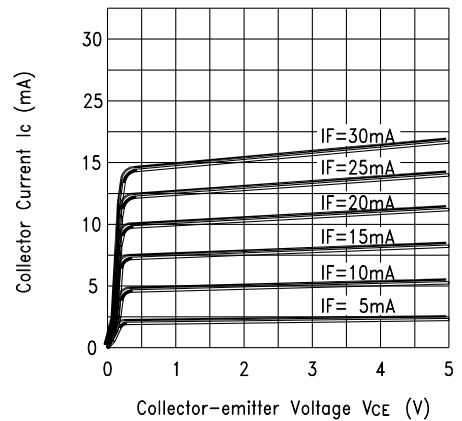

Fig.4 Collector Current vs. Collector-emitter Voltage



## TYPICAL ELECTRICAL / OPTICAL CHARACTERISTICS CURVES

(25°C Ambient Temperature Unless Otherwise Noted)

Fig.5 Collector Current vs. Ambient Temperature

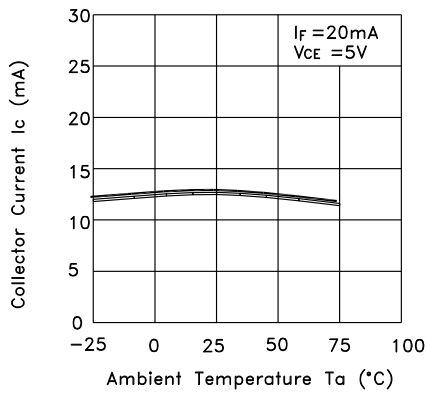

Fig.6 Collector-emitter Saturation Voltage vs. Ambient Temperature

