



# Through Hole Lamp Product Data Sheet LTL2R3KE-1-032A

Spec No.: DS20-2002-069

Effective Date: 03/13/2002

Revision: -

**LITE-ON DCC**

**RELEASE**

BNS-OD-FC001/A4

## Features

- \* High luminous intensity output.
- \* Low power consumption.
- \* High efficiency.
- \* Versatile mounting on P.C. board or panel.
- \* I.C. Compatible/low current requirements.
- \* Popular T-13/4 diameter.

## Package Dimensions

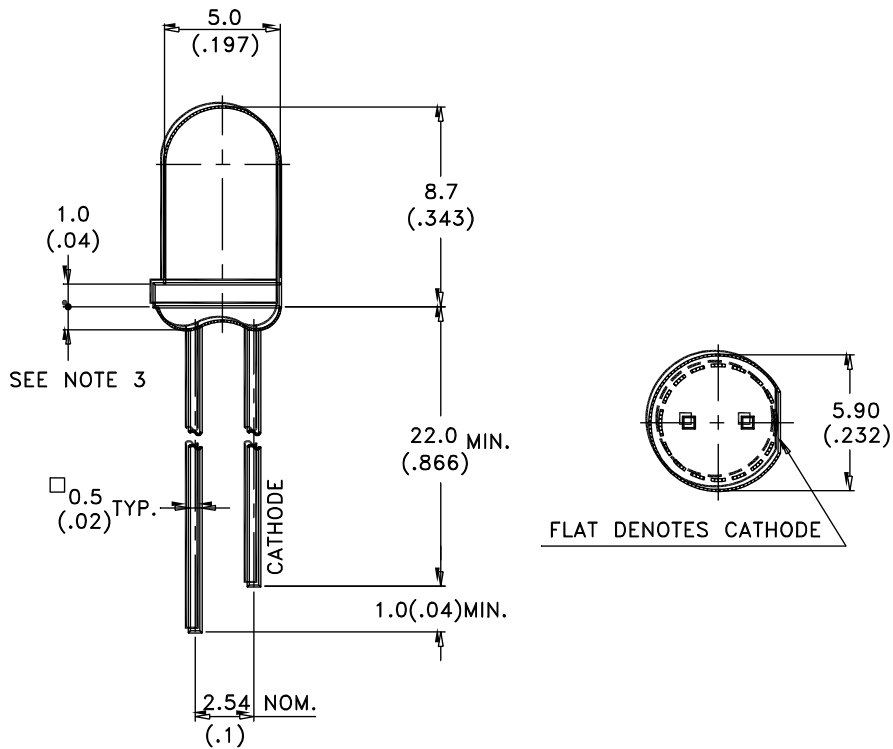

Part No.	Lens	Source Color
LTL2R3KE-1-032A	Red Diffused	AllnGaP Red

### Notes:

1. All dimensions are in millimeters (inches).
2. Tolerance is  $\pm 0.25\text{mm}(.010\text{'})$  unless otherwise noted.
3. Protruded resin under flange is 1.0mm(.04") max.
4. Lead spacing is measured where the leads emerge from the package.
5. Specifications are subject to change without notice.



**Absolute Maximum Ratings at TA=25°C**

Parameter	Maximum Rating	Unit
Power Dissipation	75	mW
Peak Forward Current (1/10 Duty Cycle, 0.1ms Pulse Width)	90	mA
Continuous Forward Current	30	mA
Derating Linear From 50°C	0.4	mA/°C
Reverse Voltage	5	V
Operating Temperature Range	-40°C to + 100°C	
Storage Temperature Range	-55°C to + 100°C	
Lead Soldering Temperature [1.6mm(.063") From Body]	260°C for 5 Seconds	

## Electrical / Optical Characteristics at TA=25°C

Parameter	Symbol	Min.	Typ.	Max.	Unit	Test Condition
Luminous Intensity	I <sub>v</sub>	200	300		mcd	I <sub>F</sub> = 20mA Note 1
Viewing Angle	2θ <sub>1/2</sub>		45		deg	Note 2 (Fig.5)
Peak Emission Wavelength	λ <sub>P</sub>		632		nm	Measurement @Peak (Fig.1)
Dominant Wavelength	λ <sub>d</sub>		624		nm	Note 4
Spectral Line Half-Width	Δλ		20		nm	
Forward Voltage	V <sub>F</sub>		2.05	2.4	V	I <sub>F</sub> = 20mA
Reverse Current	I <sub>R</sub>			100	μA	V <sub>R</sub> = 5V
Capacitance	C		40		pF	V <sub>F</sub> = 0, f = 1MHz

- NOTE: 1. Luminous intensity is measured with a light sensor and filter combination that approximates the CIE eye-response curve.
2. θ<sub>1/2</sub> is the off-axis angle at which the luminous intensity is half the axial luminous intensity.
3. I<sub>v</sub> classification code is marked on each packing bag.
4. The dominant wavelength, λ<sub>d</sub> is derived from the CIE chromaticity diagram and represents the single wavelength which defines the color of the device.

## Typical Electrical / Optical Characteristics Curves

(25°C Ambient Temperature Unless Otherwise Noted)

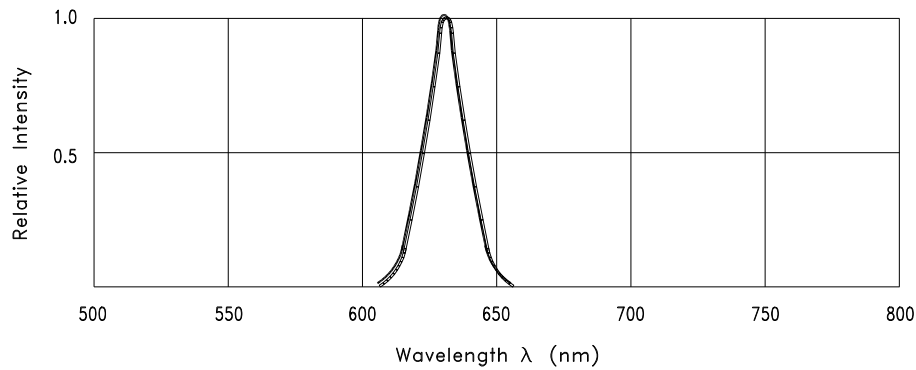

Fig.1 Relative Intensity vs. Wavelength

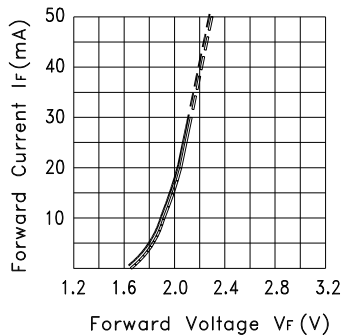

Fig.2 Forward Current vs. Forward Voltage

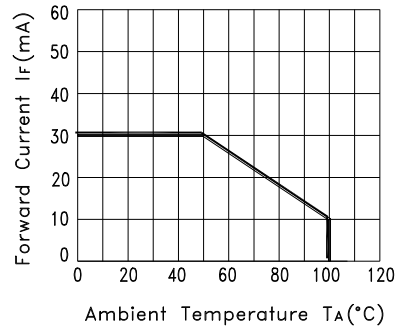

Fig.3 Forward Current Derating Curve

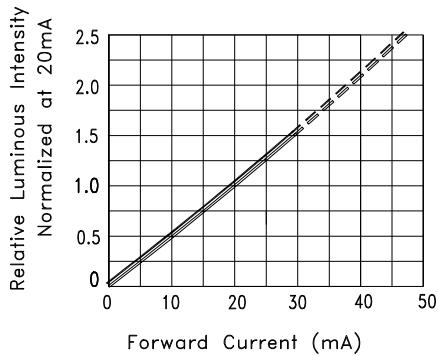

Fig.4 Relative Luminous Intensity vs. Forward Current

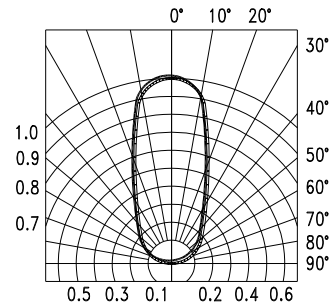
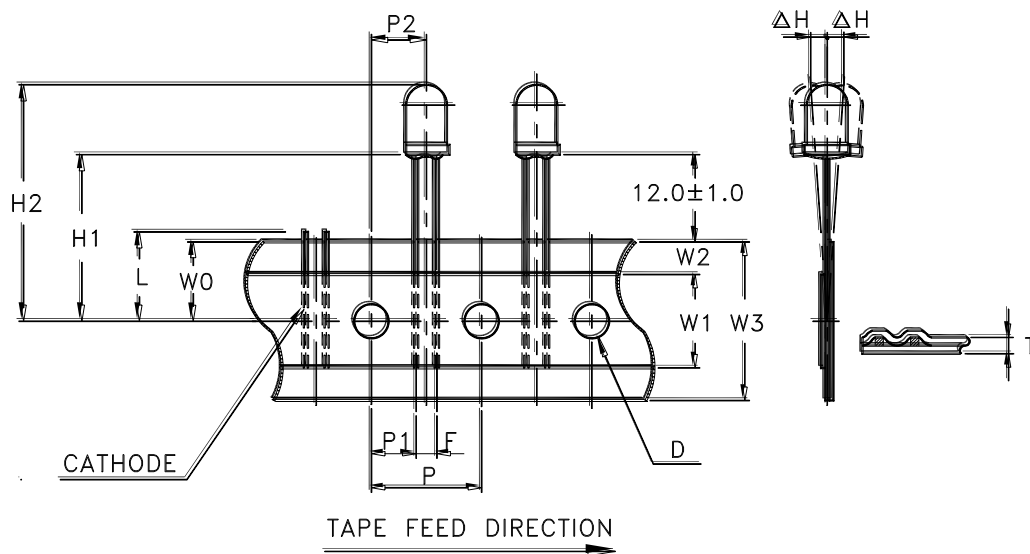

Fig.5 Spatial Distribution

## Features

- \* Compatible with radial lead automatic insertion equipment.
- \* Most radial lead plastic lead lamps available packaged in tape and folding.
- \* 2.54mm (0.1") straight lead spacing available.
- \* Folding packaging simplifies handling and testing.

## Package Dimensions



Item	Symbol	Specification			
		Minimum		Maximum	
		mm	inch	mm	inch
Tape Feed Hole Diameter	D	3.8	0.149	4.2	0.165
Component Lead Pitch	F	2.3	0.091	3.0	0.118
Front to Rear Deflection	$\Delta H$	--	--	2.0	0.078
Feed Hole to Bottom of Component	H1	20.0	0.787	21.0	0.827
Feed Hole to Overall Component Height	H2	28.4	1.118	30.0	1.181
Lead Length After Component Height	L	W0		11.0	0.433
Feed Hole Pitch	P	12.4	0.488	13.0	0.511
Lead Location	P1	4.4	0.173	5.8	0.228
Center of Component Location	P2	5.05	0.198	7.65	0.301
Total Tape Thickness	T	--	--	0.90	0.035
Feed Hole Location	W0	8.5	0.334	9.75	0.384
Adhesive Tape Width	W1	14.5	0.571	15.5	0.610
Adhesive Tape Position	W2	0	0	3.0	0.118
Tape Width	W3	17.5	0.689	19.0	0.748