



Through Hole Lamp Product Data Sheet LTW-87HD4B-032A

Spec No.: DS20-2012-0221

Effective Date: 12/04/2012

Revision: -

LITE-ON DCC

RELEASE

BNS-OD-FC001/A4

Features

- * Lead (Pb) free product - RoHS compliant
- * Low power consumption.
- * High efficiency & reliability.
- * Versatile mounting on p.c. board or panel.
- * I.C. compatible/low current requirement.
- * Popular T-1 diameter.

Package Dimensions

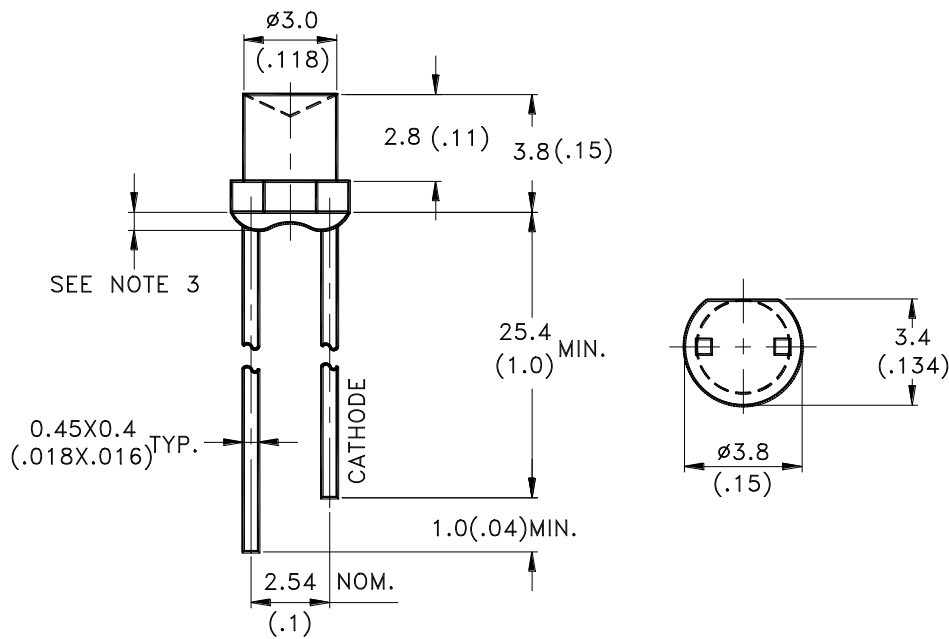

Part No.	Lens Color	Emitted Color
LTW-87HD4B-032A	Water Clear	InGaN White

NOTES:

1. All dimensions are in millimeters (inches).
2. Tolerance is $\pm 0.25\text{mm}(.010\text{'})$ unless otherwise noted.
3. Protruded resin under flange is 1.0mm (.04") max.
4. Lead spacing is measured where the leads emerge from the package.
5. Specifications are subject to change without notice.



LITE-ON TECHNOLOGY CORPORATION

Property of Lite-On Only

Absolute Maximum Ratings at Ta=25°C

PARAMETER	MAXIMUM RATING	UNIT
Power Dissipation	108	mW
Peak Forward Current (1/10 Duty Cycle, 0.1ms Pulse Width)	40	mA
DC Forward Current	20	mA
Operating Temperature Range	-30°C to + 85°C	
Storage Temperature Range	-40°C to + 100°C	
Lead Soldering Temperature [2.0mm(.08") From Body]	260°C for 5 Seconds Max.	

Electrical / Optical Characteristics at Ta=25°C

PARAMETER	SYMBOL	MIN.	TYP.	MAX.	UNIT	TEST CONDITION
Luminous Intensity	I _v	50	(140)		mcd	I _F = 20mA Note 1,2,3 I _v Spec. Table
Viewing Angle	2θ _{1/2}	-	130	-	deg	Note 4
Chromaticity Coordinates	x	-	0.25	-		I _F = 20mA Note 5
	y	-	0.21	-		Hue Spec. Table & Chromaticity Diagram
Forward Voltage	V _F	-	3.3	3.6	V	I _F = 20mA
Reverse Current	I _R	-	-	2	μA	V _R = 5V, Note 6

NOTE:

1. Luminous intensity is measured with a light sensor and filter combination that approximates the CIE eye-response curve.
2. The I_v guarantee should be added ±15% tolerance.
3. I_v classification code is marked on each packing bag.
4. θ_{1/2} is the off-axis angle at which the luminous intensity is half the axial luminous intensity.
5. The chromaticity coordinates (x, y) is derived from the 1931 CIE chromaticity diagram.
6. Reverse voltage (V_R) condition is applied for I_R test only. The device is not designed for reverse operation.

Typical Electrical / Optical Characteristics Curves

(25°C Ambient Temperature Unless Otherwise Noted)

Spectrum

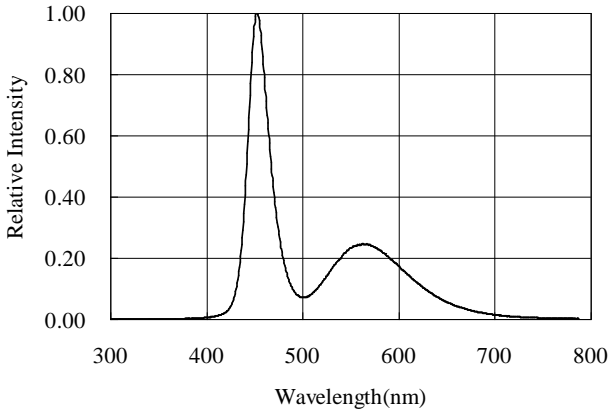

Forward Current vs. Chromaticity Coordinate

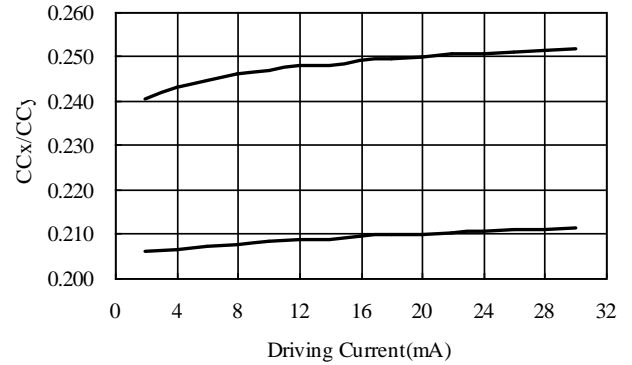

Forward Voltage vs. Forward Current

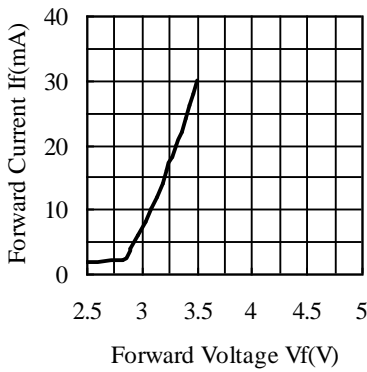

Ambient Temperature vs. Forward Current

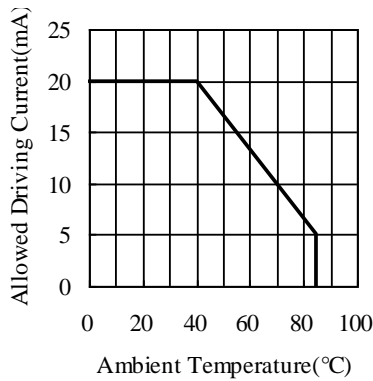

Forward Current vs. Relative Luminous Intensity

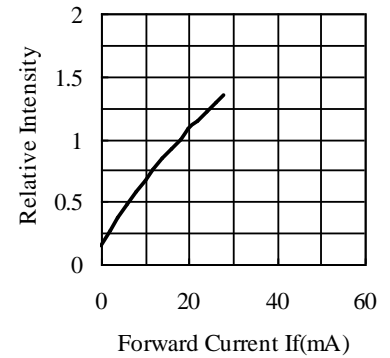

Ambient Temperature vs. Relative Luminous Intensity

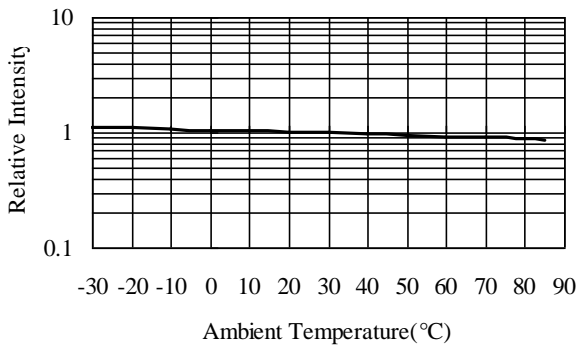

Directivity

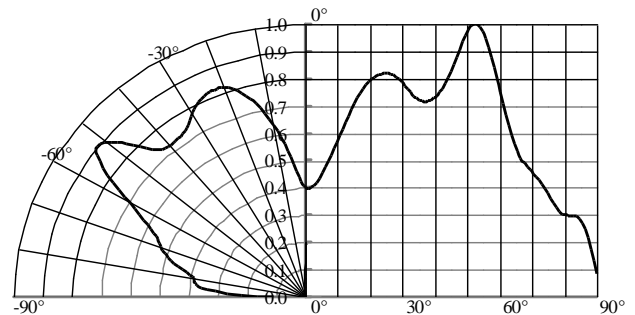

Features

- * Compatible with radial lead automatic insertion equipment.
- * Most radial lead plastic lead lamps available packaged in tape and folding.
- * 5mm (0.197") formed lead spacing available.
- * Folding packaging simplifies handling and testing.
- Reel packaging is available by removing suffix "A" on option.
- * Ammo packing series lamp type 24 LED+GAP.

Package Dimensions

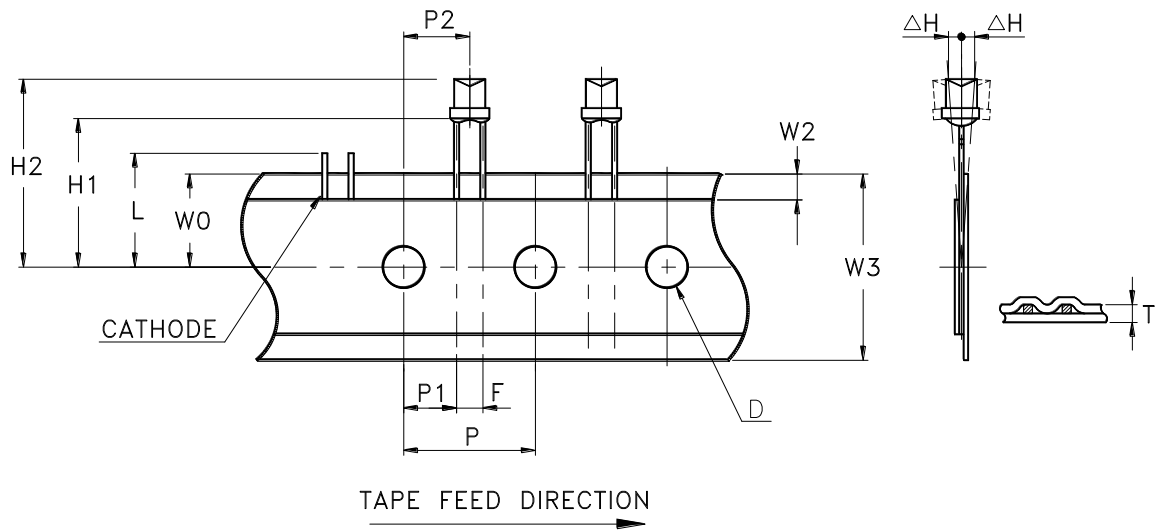

Item	Symbol	Specification			
		Minimum		Maximum	
		mm	inch	mm	inch
Tape Feed Hole Diameter	D	3.8	0.149	4.2	0.165
Component Lead Pitch	F	2.3	0.091	3.0	0.118
Front to Rear Deflection	ΔH	--	--	2.0	0.078
Feed Hole to Bottom of Component	H1	20.0	0.787	21.0	0.827
Feed Hole to Overall Component Height	H2	23.5	0.925	25.1	0.988
Lead Length After Component Height	L	W0		11.0	0.433
Feed Hole Pitch	P	12.4	0.488	13.0	0.511
Lead Location	P1	4.4	0.173	5.80	0.228
Center of Component Location	P2	5.05	0.198	7.65	0.301
Total Taped Thickness	T	--	--	0.90	0.035
Feed Hole Location	W0	8.5	0.334	9.75	0.384
Adhesive Tape Position	W2	0	0	3.0	0.118
Tape Width	W3	17.5	0.689	19.0	0.748

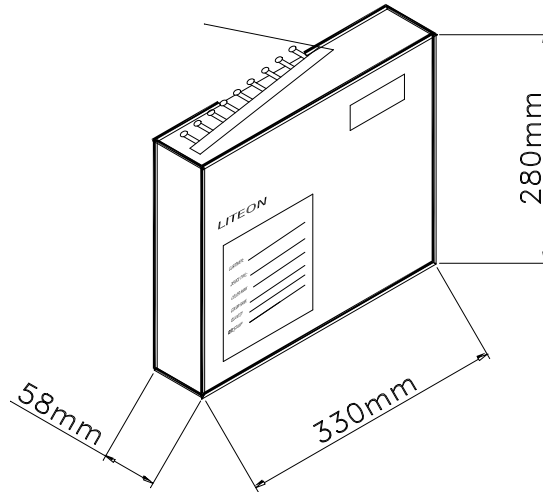
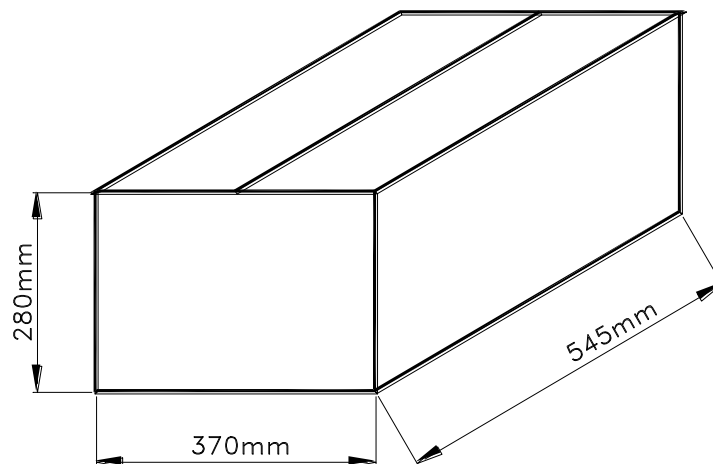
Packing Specification**3,000 pcs per inner carton**Tolerance: $\pm 5\text{mm}$ **10 Inner cartons per outer carton**
total 30,000 pcs per outer carton

Property of Lite-On Only

Optical/Electrical Bin Table

Iv Spec. Table for Reference

Iv Rank	Luminous Intensity (mcd) , If=20mA	
	min.	max.
EF	85	140
GH	140	240
JK	240	400

Luminous Intensity Measurement allowance is 15%

Vf Spec. Table for Reference

Vf Rank	Luminous Intensity (mcd) , If=20mA	
	min.	max.
3E	3.0	3.2
4E	3.2	3.4
5E	3.4	3.6

Luminous Intensity Measurement allowance is 15%

Hue Spec. Table for Reference

Hue Rank	Chromaticity Coordinates, If=20 mA				
		x	y	z	w
PB3	x	0.2057	0.2303	0.2230	0.2000
	y	0.1640	0.1440	0.1300	0.1500
PB2	x	0.2114	0.2376	0.2303	0.2057
	y	0.1780	0.1580	0.1440	0.1640
PB1	x	0.2170	0.2450	0.2376	0.2114
	y	0.1910	0.1720	0.1580	0.1780
PA3	x	0.2257	0.2537	0.2450	0.2170
	y	0.2080	0.1860	0.1720	0.1910
PA2	x	0.2344	0.2624	0.2537	0.2257
	y	0.2250	0.2000	0.1860	0.2080
PA1	x	0.2430	0.2710	0.2624	0.2344
	y	0.2410	0.2150	0.2000	0.2250
P12	x	0.2520	0.2800	0.2710	0.2430
	y	0.2590	0.2295	0.2150	0.2410
P11	x	0.2610	0.2890	0.2800	0.2520
	y	0.2770	0.2440	0.2295	0.2590
A12	x	0.2710	0.2960	0.2890	0.2610
	y	0.2960	0.2565	0.2440	0.2770
A11	x	0.2810	0.3030	0.2960	0.2710
	y	0.3150	0.2690	0.2565	0.2960

Color Coordinates Measurement allowance is ± 0.01

C.I.E. 1931 Chromaticity Diagram

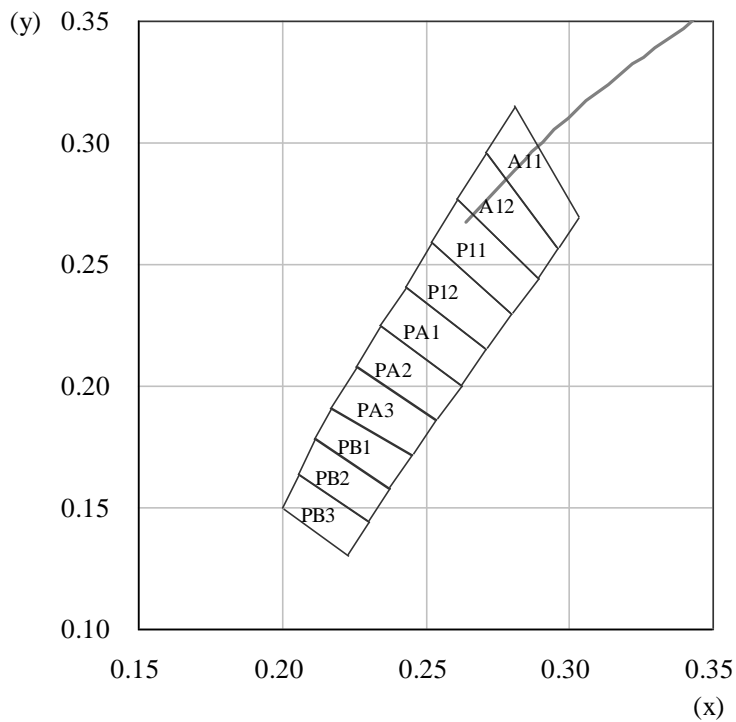
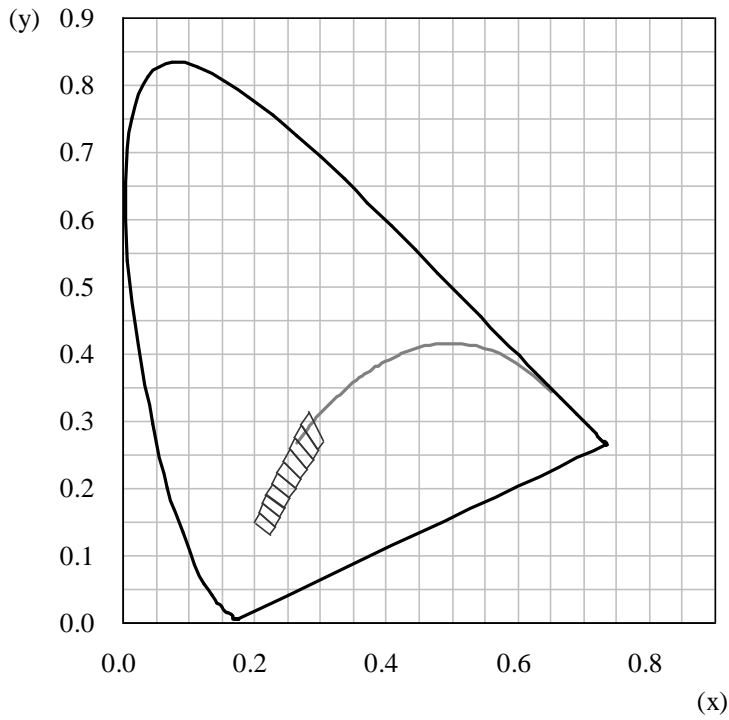

CAUTIONS

1. Application

The LEDs described here are intended to be used for ordinary electronic equipment (such as office equipment, communication equipment and household applications). Consult Liteon’s Sales in advance for information on applications in which exceptional reliability is required, particularly when the failure or malfunction of the LEDs may directly jeopardize life or health (such as in aviation, transportation, traffic control equipment, medical and life support systems and safety devices).

2. Storage

The storage ambient for the LEDs should not exceed 30°C temperature or 70% relative humidity. It is recommended that LEDs out of their original packaging are used within three months.

For extended storage out of their original packaging, it is recommended that the LEDs be stored in a sealed container with appropriate desiccant or in a dessicator with nitrogen ambient.

3. Cleaning

Use alcohol-based cleaning solvents such as isopropyl alcohol to clean the LEDs if necessary.

4. Lead Forming & Assembly

During lead forming, the leads should be bent at a point at least 3mm from the base of LED lens. Do not use the base of the leadframe as a fulcrum during forming. Lead forming must be done before soldering at normal temperature. During assembly on PCB, use minimum clinch force possible to avoid excessive mechanical stress

5. Soldering

When soldering, leave a minimum of 3mm clearance from the base of the lens to the soldering point. Dipping the lens into the solder must be avoided. Do not apply any external stress to the lead frame during soldering while the LED is at high temperature.

Recommended soldering condition:

Soldering Iron		Wave Soldering	
Temperature	350°C Max.	Pre-heat	100°C Max.
Soldering time	3 sec. Max. (one time only)	Pre-heat time	60 sec. Max.
		Solder wave	260°C Max.
		Soldering time	5 sec. Max.

Note: Excessive soldering temperature and/or time might result in deformation of the LED lens or catastrophic failure of the LED. IR re-flow is not suitable process for through-hole type LED lamp production.

6. Drive Method

An LED is a current operated device, In order to ensure intensity uniformity on multiple LEDs connected in parallel in an application; it is recommended that a current limiting resistor be incorporated in the drive circuit. In series with each LED as shown in Circuit A below.

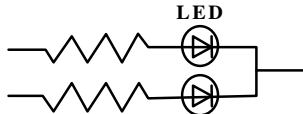
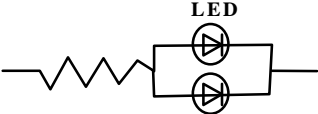
Circuit model A	Circuit model B	(A) Recommended circuit. (B) The brightness of each LED might appear different due to the differences in the I-V characteristics of those LEDs
		

7. ESD (Electrostatic Discharge)

Static Electricity or power surge will damage the LED.

Suggestions to prevent ESD damage.

- Use a conductive wrist band or anti-electrostatic glove when handling these LEDs.
- All devices, equipment, and machinery must be properly grounded.
- Work tables, storage racks, etc. should be properly grounded.
- Use ion blower to neutralize the static charge which might have built up on surface of the LED's plastic lens as a result of friction between LEDs during storage and handling.

ESD-damaged LEDs will exhibit abnormal characteristics such as high reverse leakage current, low forward voltage, or “no light up” at low currents. To verify for ESD damage, check for “light up” and Vf of the suspect LEDs at low currents.

Suggested checking list:

Training and Certification

1. Everyone working in a static-safe area is ESD-certified?
2. Training records kept and re-certification dates monitored?

Static-Safe Workstation & Work Areas

1. Static-safe workstation or work-areas have ESD signs?
2. All surfaces and objects at all static-safe workstation and within 1 ft measure less than 100V?
3. All ionize activated, positioned towards the units?
4. Each work surface mats grounding is good?

Personnel Grounding

1. Every person (including visitors) handling ESD sensitive (ESDS) items wear wrist strap, heel strap or conductive shoes with conductive flooring?
2. If conductive footwear used, conductive flooring also present where operator stand or walk?
3. Garments, hairs or anything closer than 1 ft to ESD items measure less than 100V*?
4. Every wrist strap or heel strap/conductive shoes checked daily and result recorded for all DLs?
5. All wrist strap or heel strap checkers calibration up to date?

Note: *50V for Blue LED.

Device Handling

1. Every ESDS items identified by EIA-471 labels on item or packaging?
2. All ESDS items completely inside properly closed static-shielding containers when not at static-safe workstation?
3. No static charge generators (e.g. plastics) inside shielding containers with ESDS items?
4. All flexible conductive and dissipative package materials inspected before reuse or recycle?

Others

1. Audit result reported to entity ESD control coordinator?
2. Corrective action from previous audits completed?
3. Are audit records complete and on file?

8. Others

White LED is materialized by combining blue LED and phosphors. Color of White LED is changed a little by an operating current. The appearance and specifications of the product may be modified for improvement, without prior notice.