



Through Hole Lamp
Product Data Sheet
LTL-M11KS2H300Q

Spec No. :DS20-2017-0101
Effective Date: 02/19/2021
Revision: B

LITE-ON DCC

RELEASE

BNS-OD-FC001/A4

SMT CBI
LTL-M11KS2H300Q

SMT CBI

LTL-M11KS2H300Q

| <u>Rev</u> | <u>Description</u> | <u>By</u> | <u>Date</u> |
|---|---|------------|-------------|
| P001 | Preliminary Specification (RDR-20161421-01) | Javy H. | 11/29/2016 |
| | | | |
| | | | |
| | | | |
| | | | |
| Above data for PD and Customer tracking only | | | |
| - | Upload to OBP2 | Javy H. | 09/15/2017 |
| A | Updated Drawing and Carton Packing Specification (Page 6) | Javy H. | 04/19/2020 |
| B | Updated Packing Specification | Chalerm Ya | 01/29/2021 |
| | | | |
| | | | |
| | | | |

SMT CBI LTL-M11KS2H300Q

1. Description

CBI (Circuit Board Indicator) is a black plastic right angle Holder (Housing) which mates with Lite-On LED lamps. Lite-On CBI is available in a wide variety of packages, including top-view (Spacer) or right angle and horizontal or vertical arrays which is stackable and easy to assembly.

1.1. Features

- Available for Surface Mount Technology process
- Designed for ease in circuit board assembly.
- Black case enhance contrast ratio.
- Low power consumption & High efficiency.
- Lead free product & RoHS Compliant.
- Source colors is AlInGaP yellow chip with white diffused lens
- Preconditioning: accelerate to JEDEC level 3

1.2. Applications

- Computer.
- Communication.
- Consumer.
- Industrial.

2. Outline Dimensions

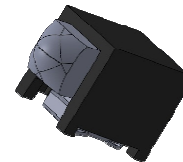
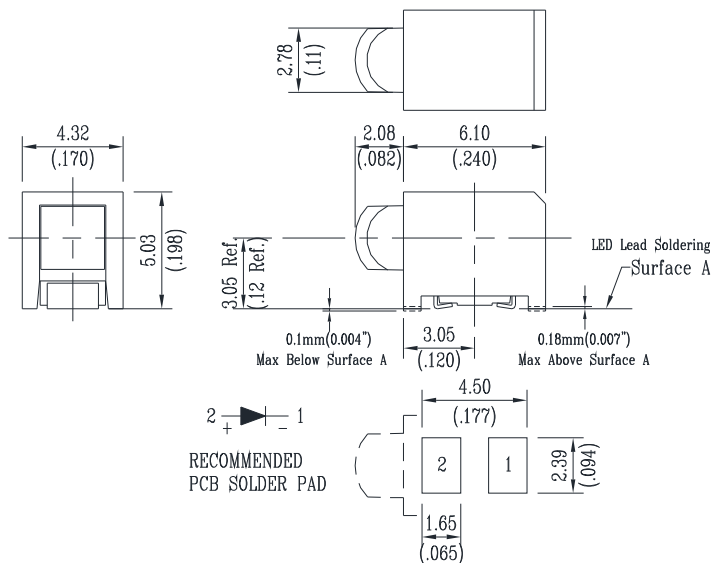

Notes :

- All dimensions are in millimeters (inches).
- Tolerance is $\pm 0.25\text{mm}$ (.010") unless otherwise noted.
- The Holder (Housing) material is plastic / black.
- LED is yellow color with white diffused lens.
- Specifications are subject to change without notice.

SMT CBI LTL-M11KS2H300Q

3. Absolute Maximum Ratings at TA=25°C

| Parameter | Maximum Rating | Unit |
|--|--------------------------|------|
| Power Dissipation | 72 | mW |
| Peak Forward Current (Duty Cycle \leq 1/10, Pulse Width \leq 0.1ms) | 80 | mA |
| DC Forward Current | 30 | mA |
| Operating Temperature Range | -40°C to + 85°C | |
| Storage Temperature Range | -40°C to + 100°C | |
| Lead Soldering Temperature [2.0mm (.079") From Body] | 260°C for 5 Seconds Max. | |

4. Electrical / Optical Characteristics at TA=25°C

| Parameter | Symbol | Min. | Typ. | Max. | Unit | Test Condition |
|--------------------------|-----------------|------|------|------|---------|------------------------------|
| Luminous Intensity | Iv | 38 | 100 | 180 | mcd | IF = 20mA Note 1, 3 |
| Viewing Angle | $\theta_{1/2}$ | | 40 | | deg | Note 2 (Fig.6) |
| Peak Emission Wavelength | λ_P | | 592 | | nm | Measurement @Peak (Fig.1) |
| Dominant Wavelength | λ_d | 582 | 589 | 595 | nm | IF=20 mA, Note 4 |
| Spectral Line Half-Width | $\Delta\lambda$ | | 15 | | nm | |
| Forward Voltage | Vf | | 2.0 | 2.5 | V | IF = 20mA |
| Reverse Current | IR | | | 10 | μ A | VR = 5V, Note 5 |

NOTE:

- Luminous intensity is measured with a light sensor and filter combination that approximates the CIE eye-response curve.
- $\theta_{1/2}$ is the off-axis angle at which the luminous intensity is half the axial luminous intensity.
- Iv classification code is marked on each packing bag.
- The dominant wavelength, λ_d is derived from the CIE chromaticity diagram and represents the single wavelength which defines the color of the device.
- Reverse voltage (VR) condition is applied for IR test only. The device is not designed for reverse operation.

SMT CBI
LTL-M11KS2H300Q

5. Typical Electrical / Optical Characteristics Curves

(25°C Ambient Temperature Unless Otherwise Noted)

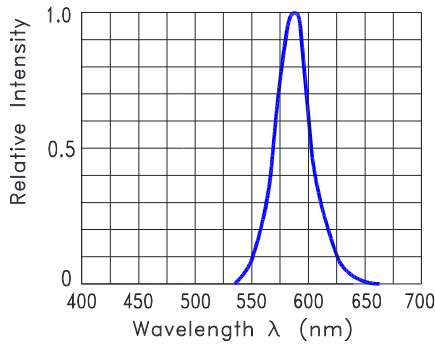

Fig.1 Relative Intensity VS. Wavelength

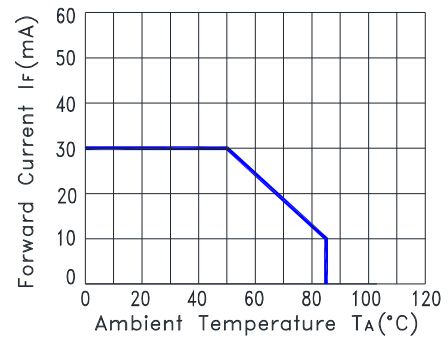

Fig.2 Forward Current Derating Curve

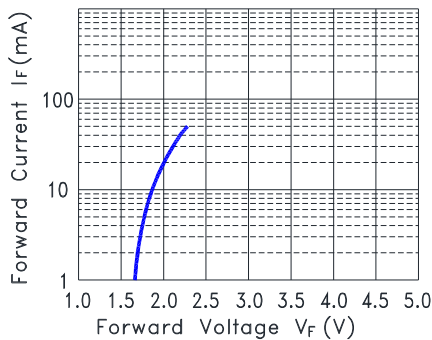

Fig.3 Forward Current vs. Forward Voltage

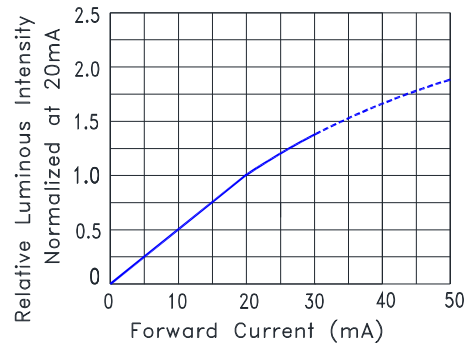

Fig.4 Relative Luminous Intensity vs. Forward Current

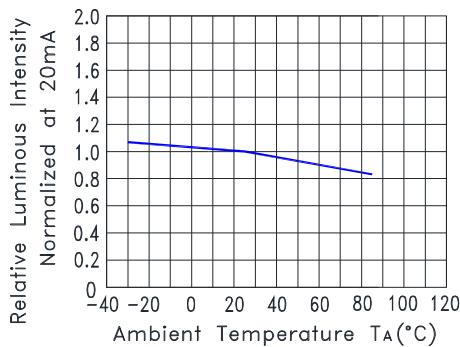

Fig.5 Relative Luminous Intensity VS. Ambient Temperature

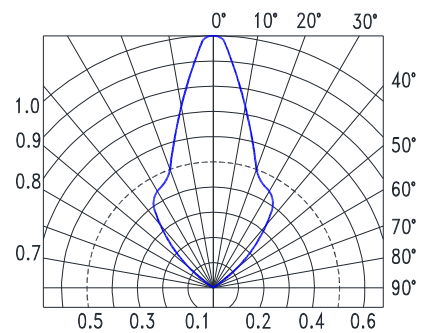
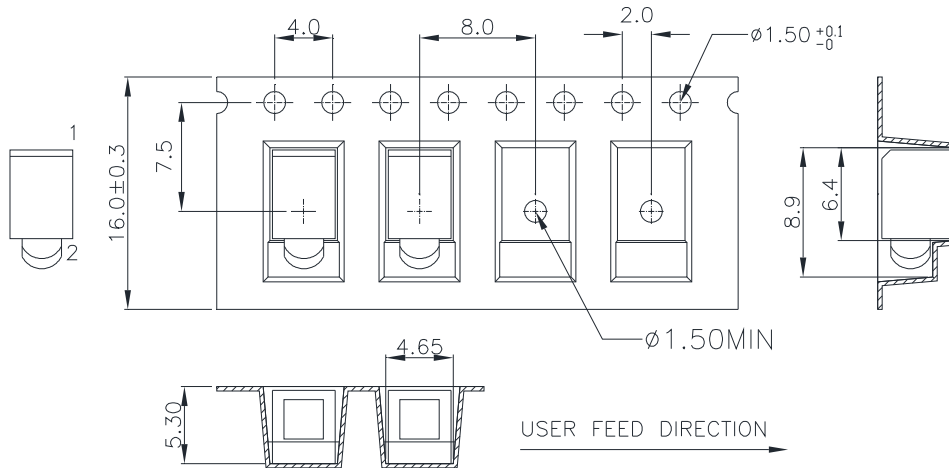

Fig.6 Spatial Distribution

SMT CBI
LTL-M11KS2H300Q

6. Packing Specification

Packing Carrier Dimensions



1. 10 sprocket hole pitch cumulative tolerance ± 0.20
2. Material : Black Conductive Polystyrene Alloy
3. Thickness : 0.40 ± 0.06 mm
4. Component load per 13" reel : 1,400pcs

Packing Reel Dimensions

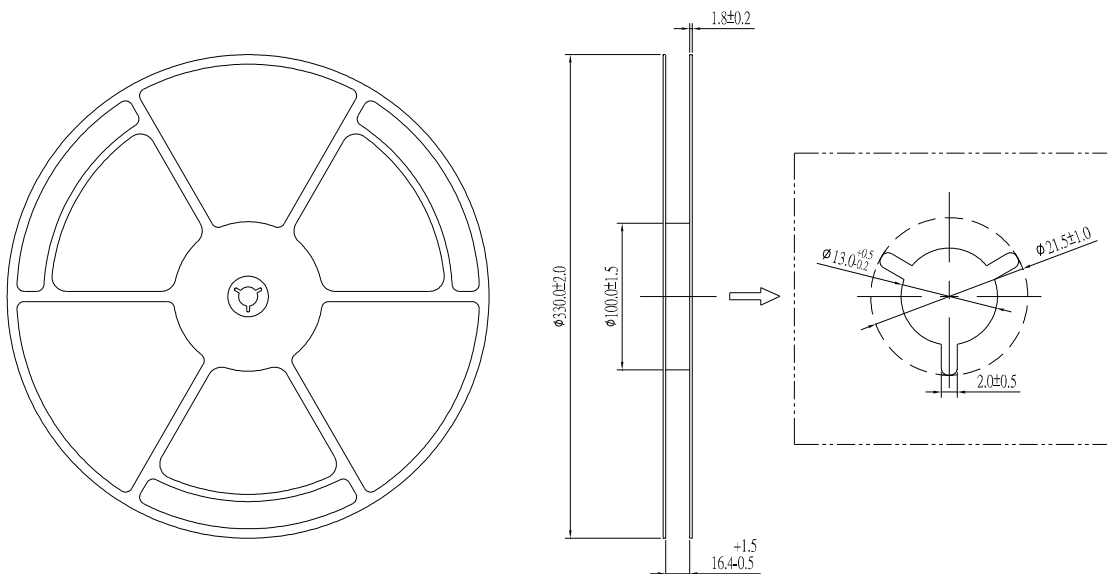

SMT CBI
LTL-M11KS2H300Q

Carton Specification

1 Reel with 1 Humidity indicator card and 1 Desiccant are packed in 1 Moisture Barrier Bag (MBB)

3 Moisture Barrier Bags packed in 1 Inner Carton

Total 4,200pcs (1,400pcs * 3) per Inner Carton



INNER CARTON
361 x 358 x 75 mm

10 Inner Cartons per Outer Carton

Total 42,000pcs (4,200pcs*10) per Outer Carton

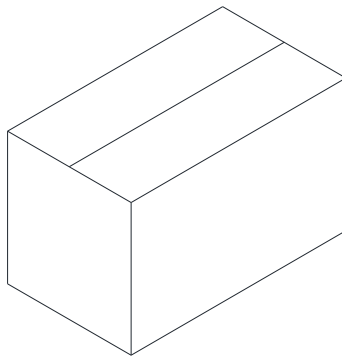

OUTER CARTON
740 x 390 x 395 mm

SMT CBI LTL-M11KS2H300Q

7. CAUTIONS

7.1. Application

The LEDs described here are intended to be used for ordinary electronic equipment (such as office equipment, communication equipment and household applications)

7.2. Storage

The package is sealed:

The LEDs should be stored at 30°C or less and 70%RH or less. And the LEDs are limited to use within one year, while the LEDs is packed in moisture-proof package with the desiccants inside.

The package is opened:

The storage ambient for the LEDs should not exceed 30°C temperature and 60% relative humidity.

It is recommended that LEDs out of their original packaging are IR-reflowed within 168hrs.

For extended storage out of their original packaging, it is recommended that the LEDs be stored in a sealed container with appropriate desiccant, or in a desiccators with nitrogen ambient.

LEDs stored out of their original packaging for more than 168hrs should be baked at about 60 deg C for at least 48 hours before solder assembly.

7.3. Cleaning

Use alcohol-based cleaning solvents such as isopropyl alcohol to clean the LEDs if necessary.

7.4. Lead Forming & Assembly

During lead forming, the leads should be bent at a point at least 3mm from the base of LED lens. Do not use the base of the lead frame as a fulcrum during forming. Lead forming must be done before soldering, at normal temperature. During assembly on PCB, use minimum clinch force possible to avoid excessive mechanical stress.

7.5. Soldering

When soldering, leave a minimum of 2mm clearance from the base of the lens/Holder to the soldering point. Dipping the lens/Holder into the solder must be avoided. Do not apply any external stress to the lead frame during soldering while the LED is at high temperature.

Recommended soldering conditions:

| Soldering iron | | Reflow soldering | |
|----------------|-----------------------------------|------------------|------------------|
| Temperature | 350°C Max. | Pre-heat | 150~200°C |
| Soldering time | 3 seconds Max. (one time only) | Pre-heat time | 120 seconds Max. |
| | | Solder wave | 260°C Max. |
| | | Soldering time | 5 seconds Max. |
| | | (two times Max.) | |

Note: Because different board designs use different number and types of devices, solder pastes, reflow ovens, and circuit boards, no single temperature profile works for all possible combinations. However, you can successfully mount your packages to the PCB by following the proper guidelines and PCB-specific characterization.

Figure (page 8) shows a sample temperature profile compliant to JEDEC standards. You can use this example as a generic target to set up your reflow process.

You should adhere to the JEDEC profile limits as well as specifications and recommendations from the solder paste manufacturer to avoid damaging the device and create a reliable solder joint.

SMT CBI LTL-M11KS2H300Q

Reflow process shall be less than 2 times, profile as below for reference.

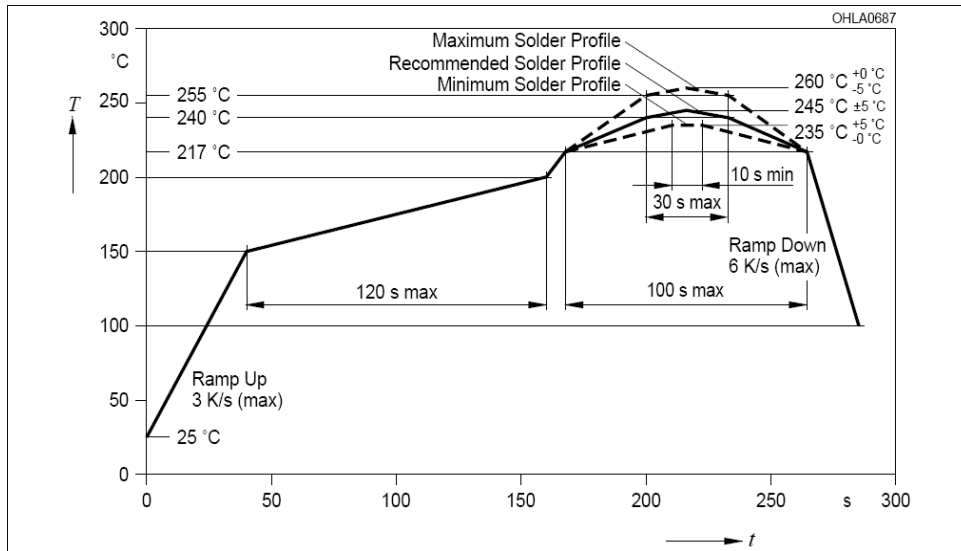

7.6. Drive Method

An LED is a current-operated device. In order to ensure intensity uniformity on multiple LEDs connected in parallel in an application, it is recommended that a current limiting resistor be incorporated in the drive circuit, in series with each LED as shown in Circuit A below.

Circuit model (A)

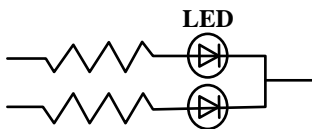

Circuit model (B)

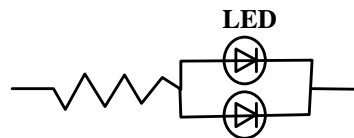

(A) Recommended circuit

(B) The brightness of each LED might appear different due to the differences in the I-V characteristics of those LEDs.

7.7. ESD (Electrostatic Discharge)

Static Electricity or power surge will damage the LED.

Suggestions to prevent ESD damage:

- Use a conductive wrist band or anti- electrostatic glove when handling these LEDs
- All devices, equipment, and machinery must be properly grounded
- Work tables, storage racks, etc. should be properly grounded
- Use ion blower to neutralize the static charge which might have built up on surface of the LEDs plastic lens as a result of friction between LEDs during storage and handing

Suggested checking list:

Training and Certification

- 7.7.1.1. Everyone working in a static-safe area is ESD-certified?
- 7.7.1.2. Training records kept and re-certification dates monitored?

Static-Safe Workstation & Work Areas

- 7.7.2.1. Static-safe workstation or work-areas have ESD signs?
- 7.7.2.2. All surfaces and objects at all static-safe workstation and within 1 ft measure less than 100V?
- 7.7.2.3. All ionizer activated, positioned towards the units?
- 7.7.2.4. Each work surface mats grounding is good?

Personnel Grounding

- 7.7.3.1. Every person (including visitors) handling ESD sensitive (ESDS) items wear wrist strap, heel strap or conductive shoes with conductive flooring?
- 7.7.3.1. If conductive footwear used, conductive flooring also present where operator stand or walk?
- 7.7.3.2. Garments, hairs or anything closer than 1 ft to ESD items measure less than 100V*?
- 7.7.3.3. Every wrist strap or heel strap/conductive shoes checked daily and result recorded for all DLs?
- 7.7.3.4. All wrist strap or heel strap checkers calibration up to date?
Note: *50V for Blue LED.

Device Handling

- 7.7.4.1. Every ESDS items identified by EIA-471 labels on item or packaging?
- 7.7.4.2. All ESDS items completely inside properly closed static-shielding containers when not at static-safe workstation?
- 7.7.4.3. No static charge generators (e.g. plastics) inside shielding containers with ESDS items?
- 7.7.4.4. All flexible conductive and dissipative package materials inspected before reuse or recycle?

Others

- 7.7.5.1. Audit result reported to entity ESD control coordinator?
- 7.7.5.2. Corrective action from previous audits completed?
- 7.7.5.3. Are audit records complete and on file?

8. Others

The appearance and specifications of the product may be modified for improvement, without prior notice.