



Through Hole Lamp Product Data Sheet LTL14CM10H51

Spec No. :DS20-2019-0077
Effective Date: 10/11/2019
Revision: -

LITE-ON DCC

RELEASE

BNS-OD-FC001/A4

Through Hole Lamp
LTL14CM10H51

Through Hole Lamp

LTL14CM10H51

<u>Rev</u>	<u>Description</u>	<u>By</u>	<u>Date</u>
P01	Preliminary Specification (RDR-20181315-01)	Javy H.	10/10/2018
P02	Update Package to Foolproof Design	Javy H.	01/25/2019
Above data for PD and Customer tracking only			
-	New Specification Upload On OPNC	Chalerm Ya.	09/10/2019

Through Hole Lamp LTL14CM10H51

1. Description

CBI (Circuit Board Indicator) is a black plastic right angle Holder (Housing) which mates with Lite-On LED lamps. Lite-On CBI is available in a wide variety of packages, including top-view (Spacer) or right angle and horizontal or vertical arrays which is stackable and easy to assembly.

1.1. Features

- Designed for ease in circuit board assembly.
- Black case enhance contrast ratio.
- Low power consumption & High efficiency.
- Lead free product & RoHS Compliant.
- T-1 lamp: emitted colors are AllnGaP 571/605nm bi-color, AllnGaP 569nm yellow green and InGaN 470nm blue.

1.2. Applications

- Computer
- Communication
- Consumer
- Industrial

2. Outline Dimensions

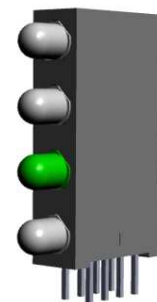
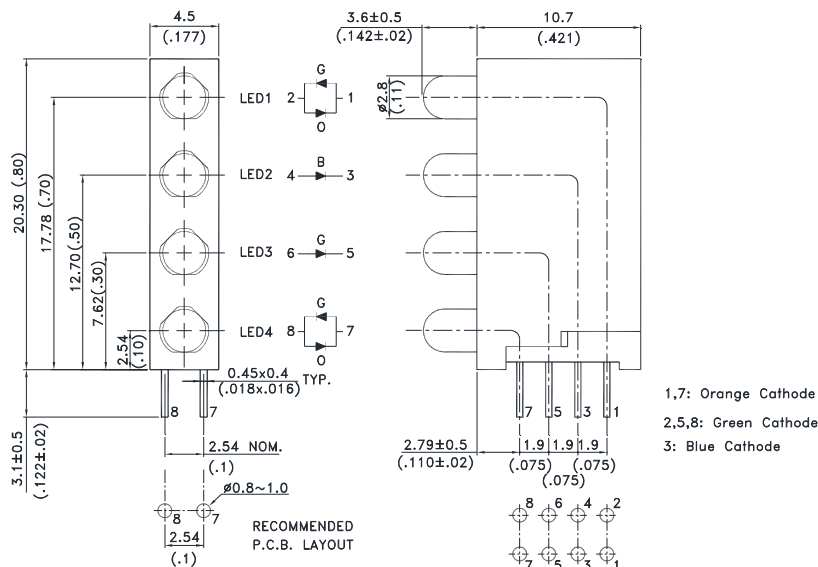

Notes :

1. All dimensions are in millimeters (inches).
2. Tolerance is $\pm 0.25\text{mm}$ (.010") unless otherwise noted.
3. The Holder (Housing) material is plastic black.
4. LED1,4 are yellow green/orange bi-color with white diffused Lens; LED2 is blue color with water clear Lens; LED3 is green (yellow green) color with green diffused Lens.
5. Specifications are subject to change without notice.

Through Hole Lamp LTL14CM10H51

3. Absolute Maximum Ratings at TA=25°C

Parameter	Orange	Green (Yellow Green)	Blue	Unit
Power Dissipation	52	52	72	mW
Peak Forward Current (Duty Cycle ≤ 1/10, Pulse Width ≤ 0.1ms)	60	60	60	mA
DC Forward Current	20	20	20	mA
Operating Temperature Range	-30°C to + 85°C		-40°C to + 85°C	
Storage Temperature Range	-40°C to + 100°C			
Lead Soldering Temperature [2.0mm (.079") From Body]	260°C for 5 Seconds Max.			

4. Electrical / Optical Characteristics at TA=25°C

Parameter	Symbol	Color		Min.		Typ.		Max.		Unit	Test Condition
		LED1, 4 LED3; LED2									
Luminous Intensity	IV	Yellow Green	Orange	20	20	80	80	140	140	mcd	IF=20mA, Note 1,4 IF=10mA (LED3)
		Yellow Green	Blue	8.7	310	15	900	29	1500		
Viewing Angle	2θ1/2	Yellow Green	Orange			110				deg	Note 2 (Fig.6)
		Yellow Green	Blue			100	45				
Peak Emission Wavelength	λP	Yellow Green	Orange			575	611			nm	Measurement @Peak (Fig.1)
		Yellow Green	Blue			572	468				
Dominant Wavelength	λd	Yellow Green	Orange	565	598	570	605	577	612	nm	IF=20 mA, Note 3 IF=10mA (LED3)
		Yellow Green	Blue	566	465	570	470	574	475		
Spectral Line Half-Width	Δλ	Yellow Green	Orange			17	15			nm	
		Yellow Green	Blue			15	25				
Forward Voltage	VF	Yellow Green	Orange			2.1	2.1	2.6	2.6	V	IF=20mA IF=10mA (LED3)
		Yellow Green	Blue			2.0	3.2	2.0	4.0		
Reverse Current	IR	Yellow Green	Orange					100		μA	VR = 5V, Note 6
		Yellow Green	Blue								

NOTE:

- Luminous intensity is measured with a light sensor and filter combination that approximates the CIE eye-response curve.
- θ1/2 is the off-axis angle at which the luminous intensity is half the axial luminous intensity.
- The dominant wavelength, λd is derived from the CIE chromaticity diagram and represents the single wavelength which defines the color of the device.
- Iv guarantee must be included with ±30% testing tolerance.
- Reverse current is controlled by dice source.
- Reverse voltage (VR) condition is applied for IR test only. The device is not designed for reverse operation.

Through Hole Lamp LTL14CM10H51

5. Typical Electrical / Optical Characteristics Curves

(25°C Ambient Temperature Unless Otherwise Noted)

LED1, 4 (Yellow Green, Orange); LED3 (Yellow Green)

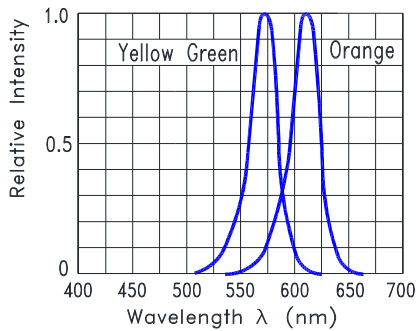

Fig.1 Relative Intensity VS. Wavelength

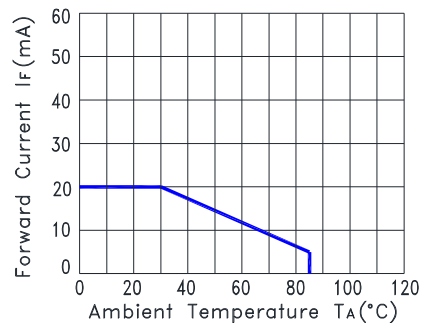

Fig.2 Forward Current Derating Curve

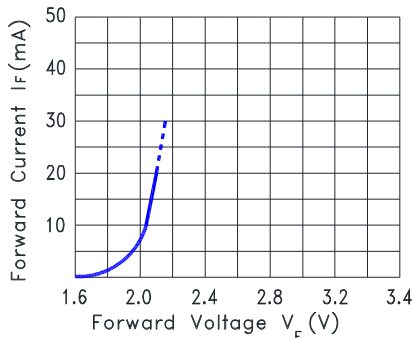

Fig.3 Forward Current vs. Forward Voltage

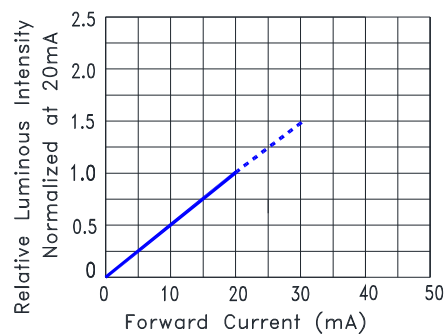

Fig.4 Relative Luminous Intensity vs. Forward Current

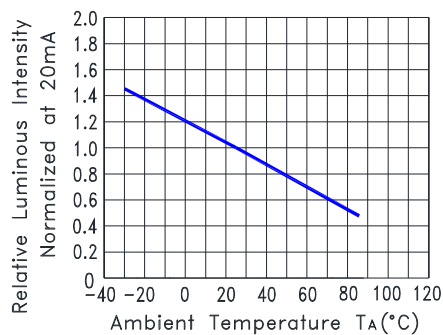

Fig.5 Relative Luminous Intensity VS. Ambient Temperature

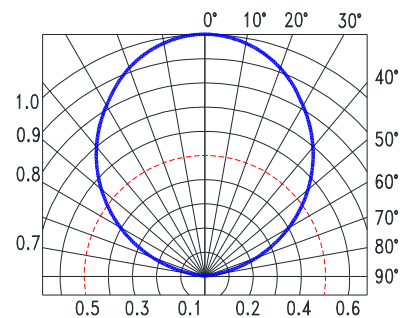

Fig.6 Spatial Distribution

Through Hole Lamp LTL14CM10H51

LED2 (Blue)

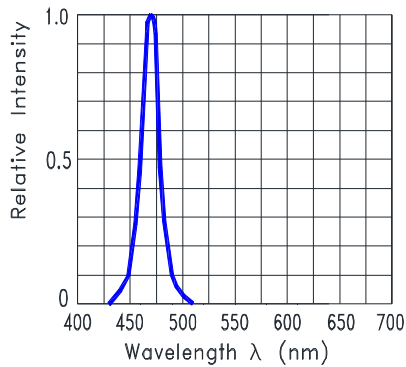

Fig.1 Relative Intensity VS. Wavelength

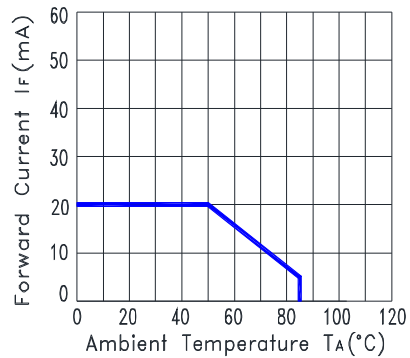

Fig.2 Forward Current Derating Curve

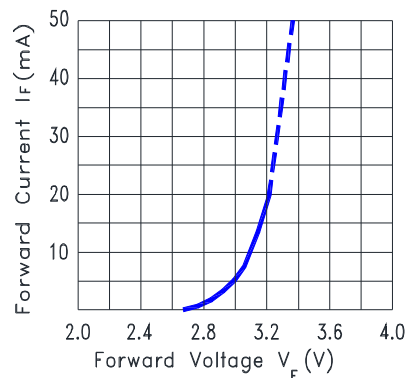

Fig.3 Forward Current vs. Forward Voltage

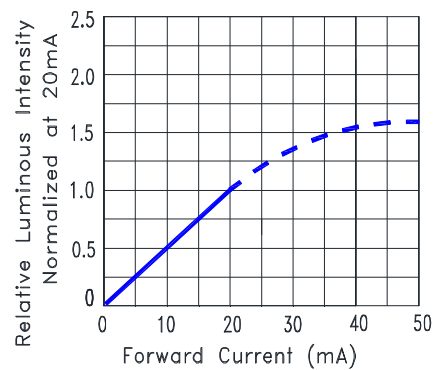

Fig.4 Relative Luminous Intensity vs. Forward Current

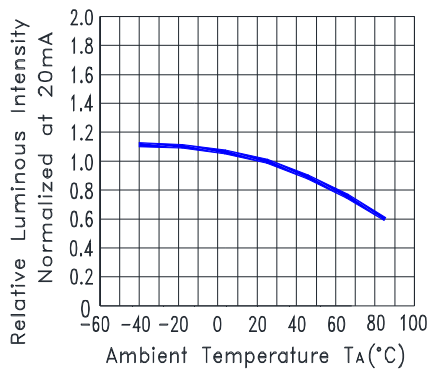

Fig.5 Relative Luminous Intensity vs. Ambient Temperature

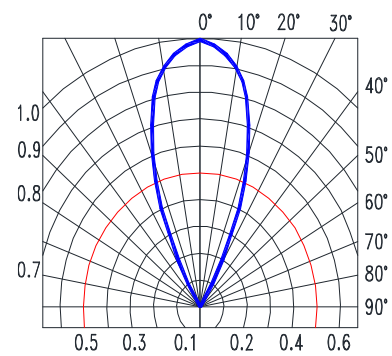
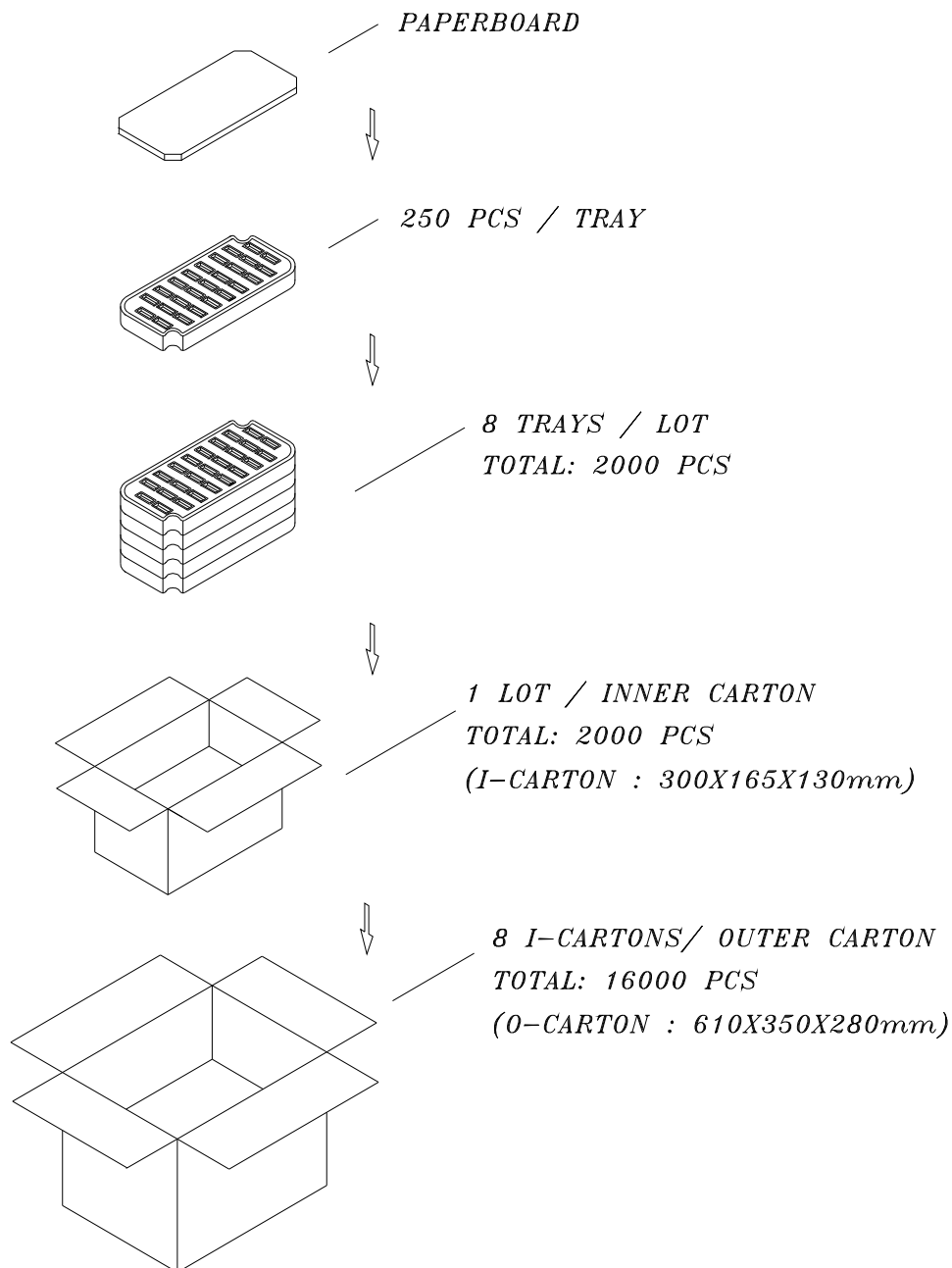

Fig.6 Spatial Distribution

Through Hole Lamp
LTL14CM10H51

6. Packing Specification



Through Hole Lamp LTL14CM10H51

7. CAUTIONS

7.1. Application

This LED lamp is good for application of indoor and outdoor sign, also ordinary electronic equipment.

7.2. Storage

The storage ambient for the LEDs should not exceed 30°C temperature or 70% relative humidity. It is recommended that LEDs out of their original packaging are used within three months. For extended storage out of their original packaging, it is recommended that the LEDs be stored in a sealed container with appropriate desiccant or in desiccators with nitrogen ambient.

7.3. Cleaning

Use alcohol-based cleaning solvents such as isopropyl alcohol to clean the LEDs if necessary.

7.4. Lead Forming & Assembly

During lead forming, the leads should be bent at a point at least 3mm from the base of LED lens. Do not use the base of the lead frame as a fulcrum during forming. Lead forming must be done before soldering, at normal temperature. During assembly on PCB, use minimum clinch force possible to avoid excessive mechanical stress.

7.5. Soldering

When soldering, leave a minimum of 2mm clearance from the base of the lens/Holder to the soldering point. Dipping the lens/Holder into the solder must be avoided. Do not apply any external stress to the lead frame during soldering while the LED is at high temperature.

Recommended soldering conditions:

Soldering iron		Wave soldering	
Temperature	350°C Max.	Pre-heat	120°C Max.
Soldering time	3 seconds Max. (one time only)	Pre-heat time	100 seconds Max.
Position	No closer than 2mm from the base of the epoxy bulb	Solder wave	260°C Max.
		Soldering time	5 seconds Max.
		Dipping Position	No lower than 2mm from the base of the epoxy bulb

Note: Excessive soldering temperature and/or time might result in deformation of the LED lens or catastrophic failure of the LED.

IR reflow is not suitable process for through hole type LED lamp product. Max temperature of wave soldering is not means that Holder's HDT/Melting temperature.

7.6. Drive Method

An LED is a current-operated device. In order to ensure intensity uniformity on multiple LEDs connected in parallel in an application, it is recommended that a current limiting resistor be incorporated in the drive circuit, in series with each LED as shown in Circuit A below.

Circuit model (A)

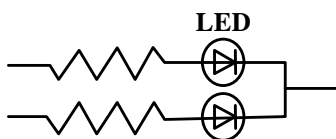

Circuit model (B)

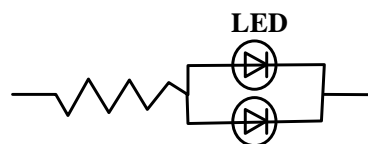

(A) Recommended circuit

(B) The brightness of each LED might appear different due to the differences in the I-V characteristics of those LEDs.

Through Hole Lamp LTL14CM10H51

7.7. ESD (Electrostatic Discharge)

Static Electricity or power surge will damage the LED.

Suggestions to prevent ESD damage:

- Use a conductive wrist band or anti- electrostatic glove when handling these LEDs
- All devices, equipment, and machinery must be properly grounded
- Work tables, storage racks, etc. should be properly grounded
- Use ion blower to neutralize the static charge which might have built up on surface of the LEDs plastic lens as a result of friction between LEDs during storage and handing

Suggested checking list:

Training and Certification

- 7.7.1.1. Everyone working in a static-safe area is ESD-certified?
- 7.7.1.2. Training records kept and re-certification dates monitored?

Static-Safe Workstation & Work Areas

- 7.7.2.1. Static-safe workstation or work-areas have ESD signs?
- 7.7.2.2. All surfaces and objects at all static-safe workstation and within 1 ft measure less than 100V?
- 7.7.2.3. All ionizer activated, positioned towards the units?
- 7.7.2.4. Each work surface mats grounding is good?

Personnel Grounding

- 7.7.3.1. Every person (including visitors) handling ESD sensitive (ESDS) items wear wrist strap, heel strap or conductive shoes with conductive flooring?
- 7.7.3.1. If conductive footwear used, conductive flooring also present where operator stand or walk?
- 7.7.3.2. Garments, hairs or anything closer than 1 ft to ESD items measure less than 100V*?
- 7.7.3.3. Every wrist strap or heel strap/conductive shoes checked daily and result recorded for all DLs?
- 7.7.3.4. All wrist strap or heel strap checkers calibration up to date?

Note: *50V for Blue LED.

Device Handling

- 7.7.4.1. Every ESDS items identified by EIA-471 labels on item or packaging?
- 7.7.4.2. All ESDS items completely inside properly closed static-shielding containers when not at static-safe workstation?
- 7.7.4.3. No static charge generators (e.g. plastics) inside shielding containers with ESDS items?
- 7.7.4.4. All flexible conductive and dissipative package materials inspected before reuse or recycle?

Others

- 7.7.5.1. Audit result reported to entity ESD control coordinator?
- 7.7.5.2. Corrective action from previous audits completed?
- 7.7.5.3. Are audit records complete and on file?

Through Hole Lamp LTL14CM10H51

8. Reliability Test

Classification	Test Item	Test Condition	Sample Size	Reference Standard
Endurance Test	Operation Life	Ta = Under Room Temperature IF= Per Data Sheet Maximum Rating Test Time= 1000hrs	22 PCS (CL=90%; LTPD=10%)	MIL-STD-750D:1026 (1995) MIL-STD-883G:1005 (2006)
	High Temperature High Humidity storage	Ta = 60°C RH = 90% Test Time= 240hrs	22 PCS (CL=90%; LTPD=10%)	MIL-STD-202G:103B (2002) JEITA ED-4701:100 103 (2001)
	High Temperature Storage	Ta= 105 ± 5°C Test Time= 1000hrs	22 PCS (CL=90%; LTPD=10%)	MIL-STD-750D:1031 (1995) MIL-STD-883G:1008 (2006) JEITA ED-4701:200 201 (2001)
	Low Temperature Storage	Ta= -55 ± 5°C Test Time= 1000hrs	22 PCS (CL=90%; LTPD=10%)	JEITA ED-4701:200 202 (2001)
Environmental Test	Temperature Cycling	100°C ~ 25°C ~ -40°C ~ 25°C 30mins 5mins 30mins 5mins Test time: 30 Cycles	22 PCS (CL=90%; LTPD=10%)	MIL-STD-750D:1051 (1995) MIL-STD-883G:1010 (2006) JEITA ED-4701:100 105 (2001) JESD22-A104C (2005)
	Thermal Shock	100 ± 5°C ~ -30°C ± 5°C 15mins 15mins Test time: 30 Cycles	22 PCS (CL=90%; LTPD=10%)	MIL-STD-750D:1056 (1995) MIL-STD-883G:1011 (2006) MIL-STD-202G:107G (2002) JESD22-A106B (2004)
	Solder Resistance	T. sol = 260 ± 5°C Dwell Time= 10±1 seconds 3mm from the base of the epoxy bulb	11 PCS (CL=90%; LTPD=18.9%)	MIL-STD-750D:2031(1995) JEITA ED-4701: 300 302 (2001)
	Solderability	T. sol = 245 ± 5°C Dwell Time= 5 ± 0.5 seconds (Lead Free Solder, Coverage ≥ 95% of the dipped surface)	11 PCS (CL=90%; LTPD=18.9%)	MIL-STD-750D:2026 (1995) MIL-STD-883G:2003 (2006) MIL-STD-202G:208H (2002) IPC/EIA J-STD-002 (2004)
	Soldering Iron	T. sol = 350 ± 5°C Dwell Time= 3.5 ± 0.5 seconds	11 PCS (CL=90%; LTPD=18.9%)	MIL-STD-202G:208H (2002) JEITA ED-4701:300 302 (2001)

9. Others

The appearance and specifications of the product may be modified for improvement, without prior notice