



**Through Hole Lamp**  
**Product Data Sheet**  
LTL-R42FGY1H106T

Spec No. :DS20-2021-0005  
Effective Date: 03/06/2021  
Revision: -

**LITE-ON DCC**

**RELEASE**

**BNS-OD-FC001/A4**

**Through Hole Lamp**  
**LTL-R42FGY1H106T**

**Through Hole Lamp**

LTL-R42FGY1H106T

<u>Rev</u>	<u>Description</u>	<u>By</u>	<u>Date</u>
P01	Preliminary Specification (RDR-2020927-01)	Javy H.	10/19/2020
P02	Add Packing Specification	Javy H.	11/25/2020
P03	Update Packing Specification	Chalerm Ya.	02/24/2021
<b>Above data for PD and Customer tracking only</b>			
-	NPPR Received and Upload on OPNC.	Natthakan C.	02/24/2021

## Through Hole Lamp LTL-R42FGY1H106T

### 1. Description

CBI (Circuit Board Indicator) is a black plastic right angle Holder (Housing) which mates with Lite-On LED lamps. Lite-On CBI is available in a wide variety of packages, including top-view (Spacer) or right angle and horizontal or vertical arrays which is stackable and easy to assembly.

#### 1.1. Features

- Designed for ease in circuit board assembly.
- Black case enhance contrast ratio.
- Low power consumption & High efficiency.
- Lead free product & RoHS Compliant.
- T-1 lamp: emitted colors are AllnGaP 569nm and AllnGaP 589nm yellow chip.

#### 1.2. Applications

- Computer
- Communication
- Consumer
- Industrial

### 2. Outline Dimensions

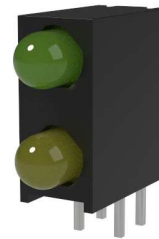
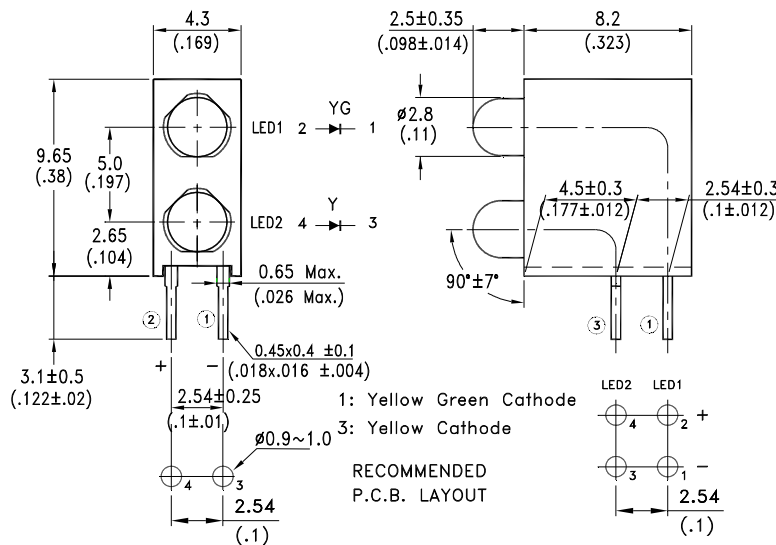

#### Notes :

1. All dimensions are in millimeters (inches).
2. Tolerance is ±0.25mm (.010") unless otherwise noted.
3. The Holder (Housing) material is plastic black or dark gray (UL 94V-0).
4. LED1 is yellow green color with green diffused Lens; LED2 yellow color with yellow diffused Lens.
5. Specifications are subject to change without notice.

## Through Hole Lamp LTL-R42FGY1H106T

### 3. Absolute Maximum Ratings at TA=25°C

Parameter	Yellow Green	Yellow	Unit
Power Dissipation	52	52	mW
Peak Forward Current (Duty Cycle ≤ 1/10, Pulse Width ≤ 10μs)	60	60	mA
DC Forward Current	20	20	mA
Operating Temperature Range	-40°C to + 85°C		
Storage Temperature Range	-45°C to + 100°C		
Lead Soldering Temperature [2.0mm (.079") From Body]	260°C for 5 Seconds Max.		

### 4. Electrical / Optical Characteristics at TA=25°C

Parameter	Symbol	LED	Color	Min.	Typ.	Max.	Unit	Test Condition
Luminous Intensity	IV	LED1	Yellow Green		15		mcd	IF=10mA, Note 1,4
		LED2	Yellow		14			
Viewing Angle	2θ1/2	LED1	Yellow Green		100		deg	Note 2 (Fig.6)
		LED2	Yellow		100			
Peak Emission Wavelength	λP	LED1	Yellow Green		572		nm	Measurement @Peak (Fig.1)
		LED2	Yellow		591			
Dominant Wavelength	λd	LED1	Yellow Green	566	570	573	nm	IF=10mA, Note 3
		LED2	Yellow	584	588	593		
Spectral Line Half-Width	Δλ	LED1	Yellow Green		15		nm	
		LED2	Yellow		15			
Forward Voltage	VF	LED1	Yellow Green	-	2.0	2.6	V	IF=10mA
		LED2	Yellow	-	2.0	2.6		
Reverse Current	IR	LED1	Yellow Green			10	μA	VR = 5V, Note5, 6
		LED2	Yellow			10		

#### NOTE:

- Luminous intensity is measured with a light sensor and filter combination that approximates the CIE eye-response curve.
- θ1/2 is the off-axis angle at which the luminous intensity is half the axial luminous intensity.
- The dominant wavelength, λd is derived from the CIE chromaticity diagram and represents the single wavelength which defines the color of the device. ±1nm testing tolerance.
- Iv guarantee must be included with ±15% testing tolerance.
- Reverse current is controlled by dice source.
- Reverse voltage (VR) condition is applied for IR test only. The device is not designed for reverse operation.

# Through Hole Lamp LTL-R42FGY1H106T

## 5. Typical Electrical / Optical Characteristics Curves

(25°C Ambient Temperature Unless Otherwise Noted)

### LED1 (Yellow Green)

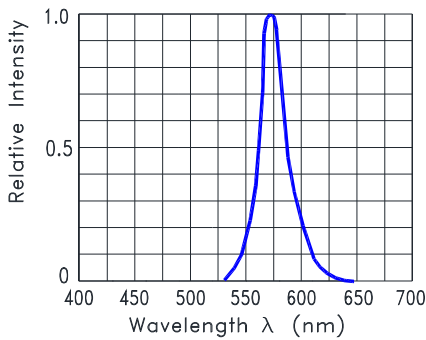

Fig.1 Relative Intensity VS.

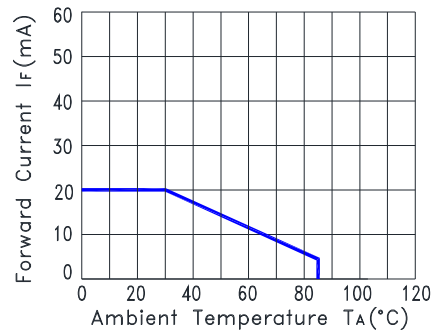

Fig.2 Forward Current Derating Curve

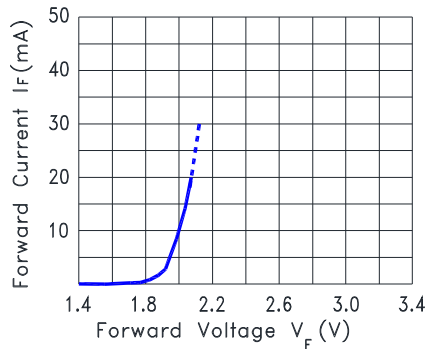

Fig.3 Forward Current vs. Forward Voltage

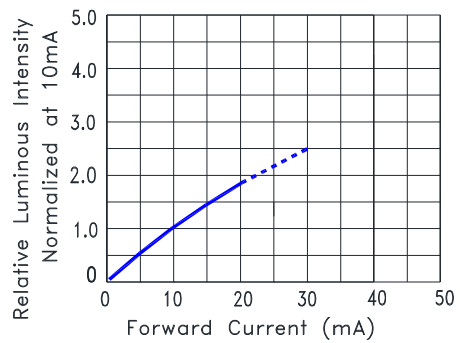

Fig.4 Relative Luminous Intensity vs. Forward Current

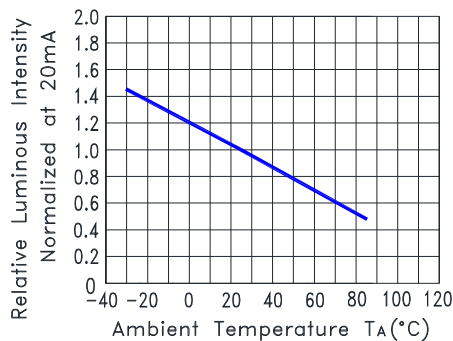

Fig.5 Relative Luminous Intensity VS. Ambient Temperature

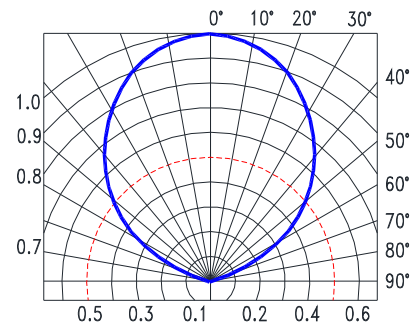

Fig.6 Spatial Distribution

# Through Hole Lamp LTL-R42FGY1H106T

LED2 (Yellow)

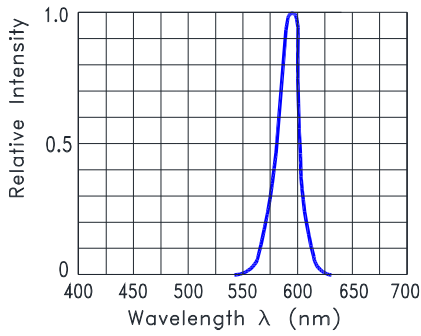

Fig.1 Relative Intensity VS. Wavelength

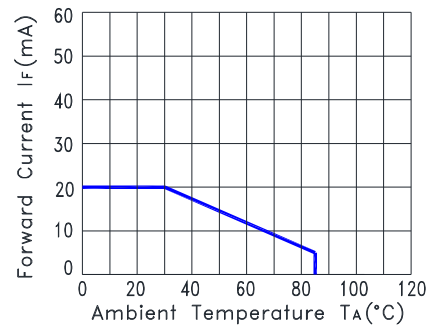

Fig.2 Forward Current Derating Curve

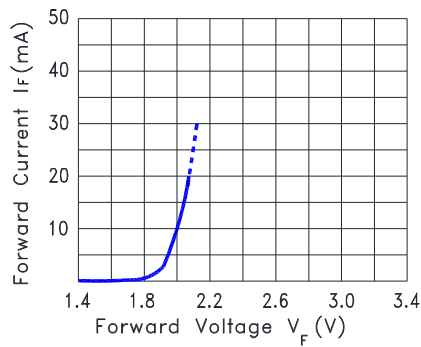

Fig.3 Forward Current vs. Forward Voltage

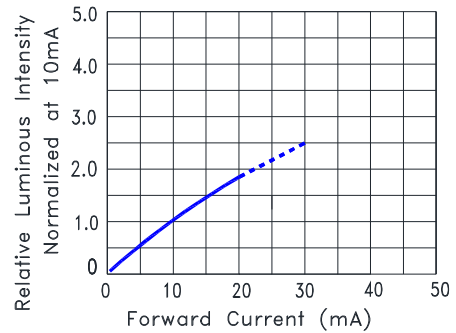

Fig.4 Relative Luminous Intensity vs. Forward Current

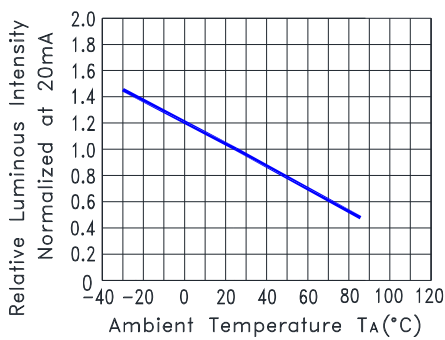

Fig.5 Relative Luminous Intensity VS. Ambient Temperature

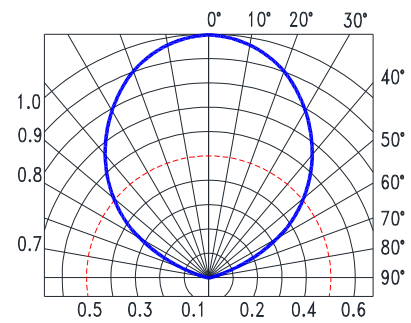
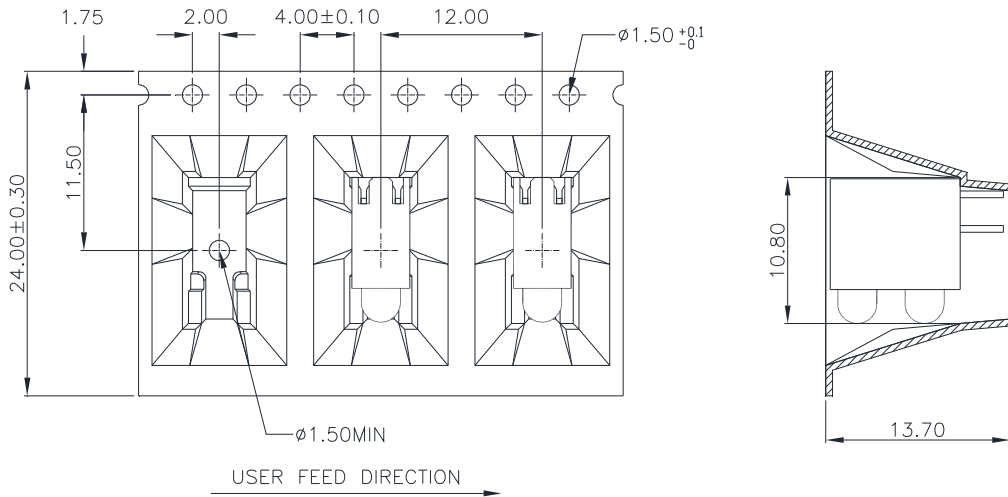

Fig.6 Spatial Distribution

# Through Hole Lamp LTL-R42FGY1H106T

## Packing Specification

### Packing Carrier Dimensions



1. 10 sprocket hole pitch cumulative tolerance  $\pm 0.20$
2. Material : Black Conductive Polystyrene Alloy
3. Thickness :  $0.50 \pm 0.06$  mm
4. Component load per 13" reel : 350pcs

### Packing Reel Dimensions

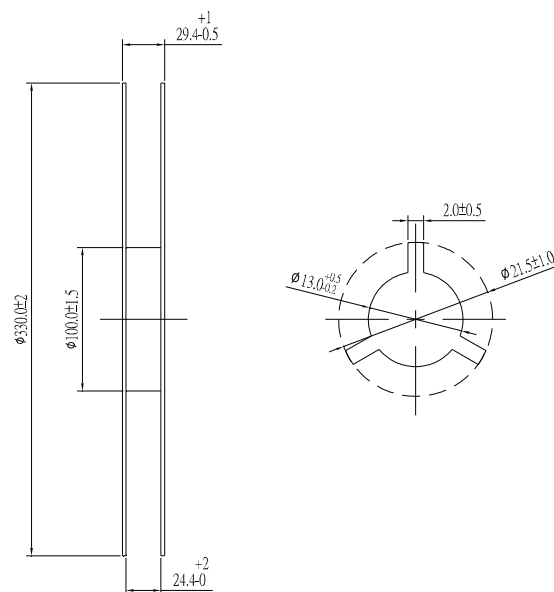

## Through Hole Lamp LTL-R42FGY1H106T

### Carton Specification

1 Reel with 1 Humidity indicator card and 1 Desiccant are packed in 1 Moisture Barrier Bag (MBB)

2 Moisture Barrier Bag packed in 1 Inner Carton

Total 700pcs (350pcs\*2) per Inner Carton

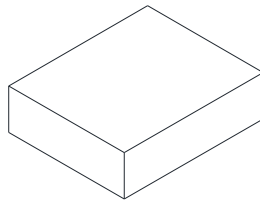

INNER CARTON  
361 x 358 x 75 mm

10 Inner Cartons per Outer Carton

Total 7,000pcs (700pcs\*10) per Outer Carton

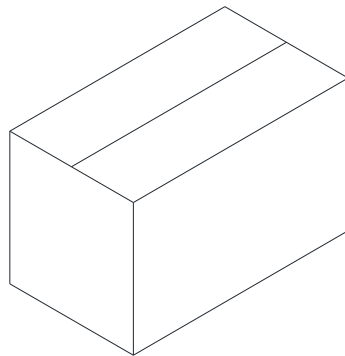

OUTER CARTON  
740 x 390 x 395 mm



## Through Hole Lamp LTL-R42FGY1H106T

### 7. CAUTIONS

#### 7.1. Application

This LED lamp is good for application of indoor and outdoor sign, also ordinary electronic equipment.

#### 7.2. Storage

The storage ambient for the LEDs should not exceed 30°C temperature or 70% relative humidity. It is recommended that LEDs out of their original packaging are used within three months. For extended storage out of their original packaging, it is recommended that the LEDs be stored in a sealed container with appropriate desiccant or in desiccators with nitrogen ambient.

#### 7.3. Cleaning

Use alcohol-based cleaning solvents such as isopropyl alcohol to clean the LEDs if necessary.

#### 7.4. Lead Forming & Assembly

During lead forming, the leads should be bent at a point at least 3mm from the base of LED lens. Do not use the base of the lead frame as a fulcrum during forming. Lead forming must be done before soldering, at normal temperature. During assembly on PCB, use minimum clinch force possible to avoid excessive mechanical stress.

#### 7.5. Soldering

When soldering, leave a minimum of 2mm clearance from the base of the lens/Holder to the soldering point. Dipping the lens/Holder into the solder must be avoided. Do not apply any external stress to the lead frame during soldering while the LED is at high temperature.

#### Recommended soldering conditions:

Soldering iron		Wave soldering	
Temperature	350°C Max.	Pre-heat	120°C Max.
Soldering time	3 seconds Max. (one time only)	Pre-heat time	100 seconds Max.
Position	No closer than 2mm from the base of the epoxy bulb	Solder wave	260°C Max.
		Soldering time	5 seconds Max.
		Dipping Position	No lower than 2mm from the base of the epoxy bulb

# Through Hole Lamp LTL-R42FGY1H106T

Reflow	
Profile Feature	Conditions
Preheat/Soak	
Temperature Min. ( $T_{smin}$ )	150°C
Temperature Max. ( $T_{smax}$ )	200°C
Time ( $t_s$ ) from ( $T_{smin}$ to $T_{smax}$ )	100 seconds Max.
Liquidous temperature ( $T_L$ )	217°C
Time ( $t_L$ ) maintained above $T_L$	60~90 seconds
Peak temperature ( $T_P$ )*	250°C
Specified classification temperature ( $T_C$ )	245°C
Time ( $t_p$ ) within 5°C of the temperature $T_C$	30 seconds Max.
Time 25°C to peak temperature	5 minutes Max.

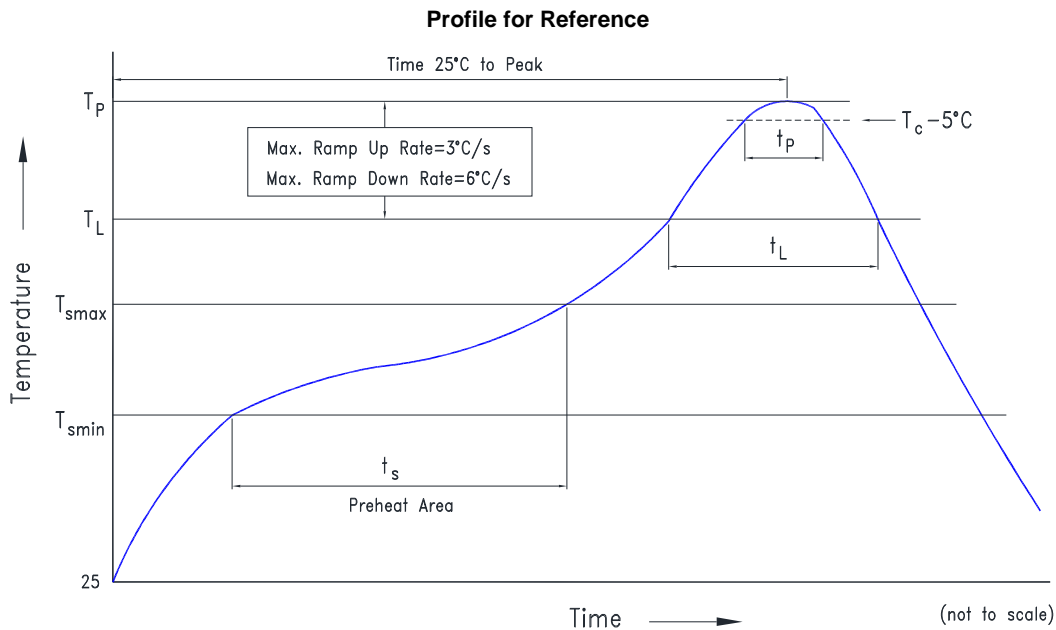

Note: Excessive soldering temperature and/or time might result in deformation of the LED lens or catastrophic failure of the LED.

## Through Hole Lamp LTL-R42FGY1H106T

### 7.6. Drive Method

An LED is a current-operated device. In order to ensure intensity uniformity on multiple LEDs connected in parallel in an application, it is recommended that a current limiting resistor be incorporated in the drive circuit, in series with each LED as shown in Circuit A below.

**Circuit model (A)**

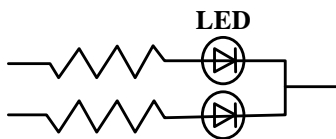

**Circuit model (B)**

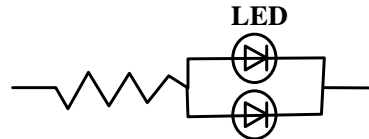

(A) Recommended circuit

(B) The brightness of each LED might appear different due to the differences in the I-V characteristics of those LEDs.

### 7.7. ESD (Electrostatic Discharge)

**Static Electricity or power surge will damage the LED.**

**Suggestions to prevent ESD damage:**

- Use a conductive wrist band or anti- electrostatic glove when handling these LEDs
- All devices, equipment, and machinery must be properly grounded
- Work tables, storage racks, etc. should be properly grounded
- Use ion blower to neutralize the static charge which might have built up on surface of the LEDs plastic lens as a result of friction between LEDs during storage and handling

**Suggested checking list:**

#### Training and Certification

- 7.7.1.1. Everyone working in a static-safe area is ESD-certified?
- 7.7.1.2. Training records kept and re-certification dates monitored?

#### Static-Safe Workstation & Work Areas

- 7.7.2.1. Static-safe workstation or work-areas have ESD signs?
- 7.7.2.2. All surfaces and objects at all static-safe workstation and within 1 ft measure less than 100V?
- 7.7.2.3. All ionizer activated, positioned towards the units?
- 7.7.2.4. Each work surface mats grounding is good?

#### Personnel Grounding

- 7.7.3.1. Every person (including visitors) handling ESD sensitive (ESDS) items wear wrist strap, heel strap or conductive shoes with conductive flooring?
- 7.7.3.1. If conductive footwear used, conductive flooring also present where operator stand or walk?
- 7.7.3.2. Garments, hairs or anything closer than 1 ft to ESD items measure less than 100V\*?
- 7.7.3.3. Every wrist strap or heel strap/conductive shoes checked daily and result recorded for all DLs?
- 7.7.3.4. All wrist strap or heel strap checkers calibration up to date?

Note: \*50V for Blue LED.

#### Device Handling

- 7.7.4.1. Every ESDS items identified by EIA-471 labels on item or packaging?
- 7.7.4.2. All ESDS items completely inside properly closed static-shielding containers when not at static-safe workstation?
- 7.7.4.3. No static charge generators (e.g. plastics) inside shielding containers with ESDS items?
- 7.7.4.4. All flexible conductive and dissipative package materials inspected before reuse or recycle?

#### Others

- 7.7.5.1. Audit result reported to entity ESD control coordinator?
- 7.7.5.2. Corrective action from previous audits completed?
- 7.7.5.3. Are audit records complete and on file?

## Through Hole Lamp LTL-R42FGY1H106T

### 8. Reliability Test

Classification	Test Item	Test Condition	Sample Size	Reference Standard
Endurance Test	Operation Life	Ta = Under Room Temperature IF= Per Data Sheet Maximum Rating Test Time= 1000hrs	22 PCS (CL=90%; LTPD=10%)	MIL-STD-750D:1026 (1995) MIL-STD-883G:1005 (2006)
	High Temperature High Humidity storage	Ta = 60°C RH = 90% Test Time= 240hrs	22 PCS (CL=90%; LTPD=10%)	MIL-STD-202G:103B (2002) JEITA ED-4701:100 103 (2001)
	High Temperature Storage	Ta= 105 ± 5°C Test Time= 1000hrs	22 PCS (CL=90%; LTPD=10%)	MIL-STD-750D:1031 (1995) MIL-STD-883G:1008 (2006) JEITA ED-4701:200 201 (2001)
	Low Temperature Storage	Ta= -55 ± 5°C Test Time= 1000hrs	22 PCS (CL=90%; LTPD=10%)	JEITA ED-4701:200 202 (2001)
Environmental Test	Temperature Cycling	100°C ~ 25°C ~ -40°C ~ 25°C 30mins 5mins 30mins 5mins Test time: 30 Cycles	22 PCS (CL=90%; LTPD=10%)	MIL-STD-750D:1051 (1995) MIL-STD-883G:1010 (2006) JEITA ED-4701:100 105 (2001) JESD22-A104C (2005)
	Thermal Shock	100 ± 5°C ~ -30°C ± 5°C 15mins 15mins Test time: 30 Cycles	22 PCS (CL=90%; LTPD=10%)	MIL-STD-750D:1056 (1995) MIL-STD-883G:1011 (2006) MIL-STD-202G:107G (2002) JESD22-A106B (2004)
	Solder Resistance	T. sol = 260 ± 5°C Dwell Time= 10±1 seconds 3mm from the base of the epoxy bulb	11 PCS (CL=90%; LTPD=18.9%)	MIL-STD-750D:2031(1995) JEITA ED-4701: 300 302 (2001)
	Solderability	T. sol = 245 ± 5°C Dwell Time= 5 ± 0.5 seconds (Lead Free Solder, Coverage ≥ 95% of the dipped surface)	11 PCS (CL=90%; LTPD=18.9%)	MIL-STD-750D:2026 (1995) MIL-STD-883G:2003 (2006) MIL-STD-202G:208H (2002) IPC/EIA J-STD-002 (2004)
	Soldering Iron	T. sol = 350 ± 5°C Dwell Time= 3.5 ± 0.5 seconds	11 PCS (CL=90%; LTPD=18.9%)	MIL-STD-202G:208H (2002) JEITA ED-4701:300 302 (2001)

### 9. Others

The appearance and specifications of the product may be modified for improvement, without prior notice