



Display & Mobile Product Data Sheet

LTW-206DCG-TMS

Spec No.: DS23-2014-0045

Effective Date: 12/27/2014

Revision: -

LITE-ON DCC

RELEASE

BNS-OD-FC001/A4

Display & Mobile LTW-206DCG-TMS

1. Description

The LTW (LiteOn White PLCC LED) is a revolutionary, energy efficient and ultra compact new light source, combining the lifetime and reliability advantages of Light Emitting Diodes with the brightness of conventional lighting. It gives you total design freedom and unmatched brightness, creating a new opportunities for solid state lighting to displace conventional lighting technologies..

1. Features

- High power LED light source
- Instant light (less than 100 ns)
- Low voltage DC operated
- Low thermal resistance
- RoHS Compliant
- Lead free reflow solder compatible

1.2. Applications

- Reading lights (car, bus, aircraft)
- Portable (flashlight, bicycle)
- Downlighters/Orientation
- Decorative/Entertainment
- Bollards/Security/Garden
- Cove/Undershelf/Task
- Traffic signaling/Beacons/ Rail crossing and Wayside
- Indoor/Outdoor Commercial and Residential Architectural
- Edge_lit signs (Exit, point of sale)

2. Outline Dimensions

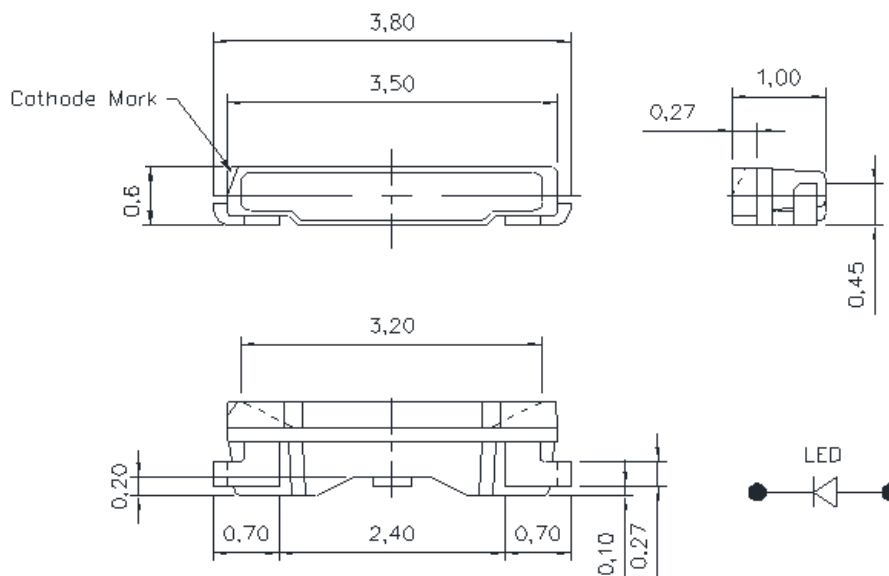

Notes :

1. All dimensions are in millimeters.
2. Tolerance is ± 0.1 mm (.004") unless otherwise noted.

Display & Mobile LTW-206DCG-TMS

Absolute Maximum Ratings at Ta=25°C

Parameter	LTW-206DCG-TMS	Unit
Power Dissipation	120	mW
Peak Forward Current (1/10 Duty Cycle, 0.1ms Pulse Width)	100	mA
DC Forward Current	30	mA
Reverse Voltage	5	V
Operating Temperature Range	-30°C to +85°C	
Storage Temperature Range	-40°C to +100°C	
Reflow Soldering Condition	260°C For 10 Seconds	

Note: Operating the LED (in an application) under reverse bias condition might result in damage or failure of the component

Suggest IR Reflow Condition :

R-Reflow Soldering Profile for lead free soldering (Acc. to J-STD-020D)

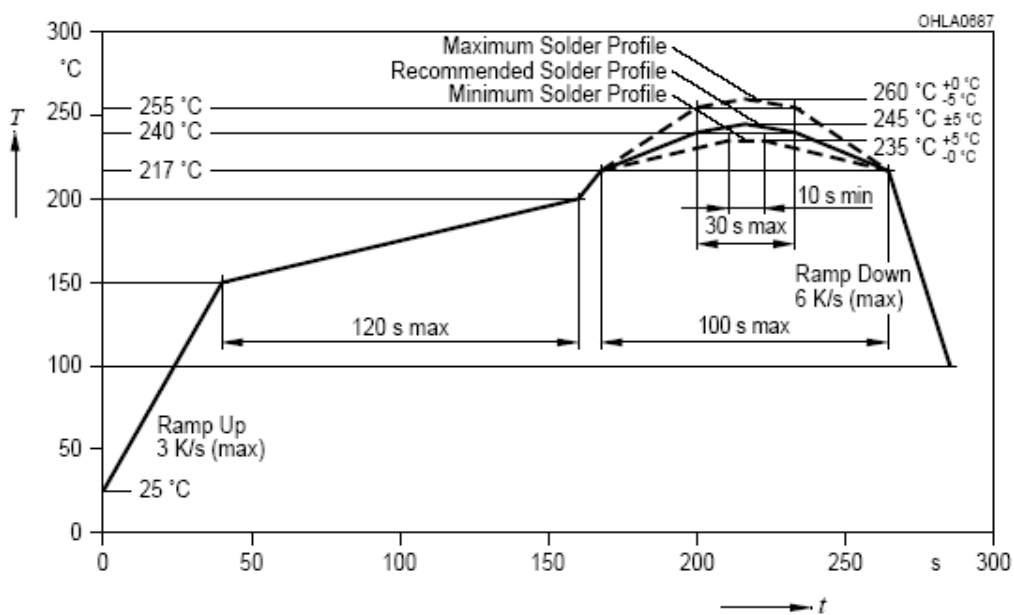

Display & Mobile LTW-206DCG-TMS

Electro-Optical Characteristics at Ta=25 °C

Parameter	Symbol	Part No. LTW-	Min.	Typ.	Max.	Unit	Test Condition
Luminous Flux	Φ_v	206DCG-TMS	6.75		9.00	lm	IF = 20mA Note 1, 2, 5
Luminous Intensity	mcd	206DCG-TMS	2200		3100	mcd	IF = 20mA Note 1, 2, 5
Viewing Angle	$2\theta_{1/2}$	206DCG-TMS		120		deg	Fig.6
Chromaticity Coordinates	x	206DCG-TMS		0.282			IF = 20mA Note 3, 5 Fig.1
	y			0.265			
Forward Voltage	VF	206DCG-TMS	2.7		3.1	V	IF = 20mA

Notes:

- Luminous flux is measured with a light sensor and filter combination that approximates the CIE eye-response curve.
- Lm classification code is marked on each packing bag.
- The chromaticity coordinates (x, y) is derived from the 1931 CIE chromaticity diagram.
- Caution in ESD:
Static Electricity and surge damages the LED. It is recommend to use a wrist band or anti-Static glove when handling the LED. All devices, equipment and machinery must be properly grounded.
- CAS140B is the test standard for the chromaticity coordinates (x, y) & lm.
- The chromaticity coordinates (x, y) guarantee should be added +/- 0.01 tolerance.

Display & Mobile LTW-206DCG-TMS

Bin Code List

V _F Spec. Table		
V _F Bin	Forward Voltage (volts) at I _F = 20mA	
	Min.	Max.
V0	2.7	2.8
V1	2.8	2.9
V2	2.9	3.0
V3	3.0	3.1

Tolerance on each Forward Voltage bin is +/- 0.05 V

Luminous Flux Spec. Table				
IV Bin	Flux (lm) and IV (mcd) at I _F = 20mA			
	lm		mcd	
	Min.	Max.	Min.	Max.
64	6.75	7.00	2200	2300
71	7.00	7.25	2300	2400
72	7.25	7.50	2400	2500
73	7.50	7.75	2500	2600
74	7.75	8.00	2600	2700
81	8.00	8.25	2700	2800
82	8.25	8.50	2800	2900
83	8.50	8.75	2900	3000
84	8.75	9.00	3000	3100

Tolerance on each Luminous Intensity bin and Luminous Flux are +/- 10%, and IV (mcd) is for reference.

Display & Mobile LTW-206DCG-TMS

Color Ranks Table											
Ranks	Color bin limits at IF = 20mA					Ranks	Color bin limits at IF = 20mA				
	CIE 1931 Chromaticity coordinates						CIE 1931 Chromaticity coordinates				
Z1	x	0.2690	0.2645	0.2680	0.2723	Z2	x	0.2723	0.2680	0.2715	0.2755
	y	0.2500	0.2425	0.2380	0.2453		y	0.2453	0.2380	0.2335	0.2405
Z3	x	0.2765	0.2723	0.2755	0.2800	Z4	x	0.2730	0.2690	0.2723	0.2765
	y	0.2525	0.2453	0.2405	0.2480		y	0.2570	0.2500	0.2453	0.2525
A1	x	0.2775	0.2730	0.2765	0.2808	A2	x	0.2808	0.2765	0.2800	0.2840
	y	0.2645	0.2570	0.2525	0.2598		y	0.2598	0.2525	0.2480	0.2550
A3	x	0.2850	0.2808	0.2840	0.2880	A4	x	0.2820	0.2775	0.2808	0.2850
	y	0.2670	0.2598	0.2550	0.2620		y	0.2720	0.2645	0.2598	0.2670
B1	x	0.2865	0.2820	0.2850	0.2893	B2	x	0.2893	0.2850	0.2880	0.2920
	y	0.2795	0.2720	0.2670	0.2743		y	0.2743	0.2670	0.2620	0.2690
B3	x	0.2935	0.2893	0.2920	0.2960	B4	x	0.2910	0.2865	0.2893	0.2935
	y	0.2815	0.2743	0.2690	0.2760		y	0.2870	0.2795	0.2743	0.2815
C1	x	0.2950	0.2910	0.2935	0.2975	C2	x	0.2975	0.2935	0.2960	0.3000
	y	0.2940	0.2870	0.2815	0.2885		y	0.2885	0.2815	0.2760	0.2830
C3	x	0.3015	0.2975	0.3000	0.3040	C4	x	0.2990	0.2950	0.2975	0.3015
	y	0.2955	0.2885	0.2830	0.2900		y	0.3010	0.2940	0.2885	0.2955

Tolerance on each Hue (x, y) bin is +/- 0.01

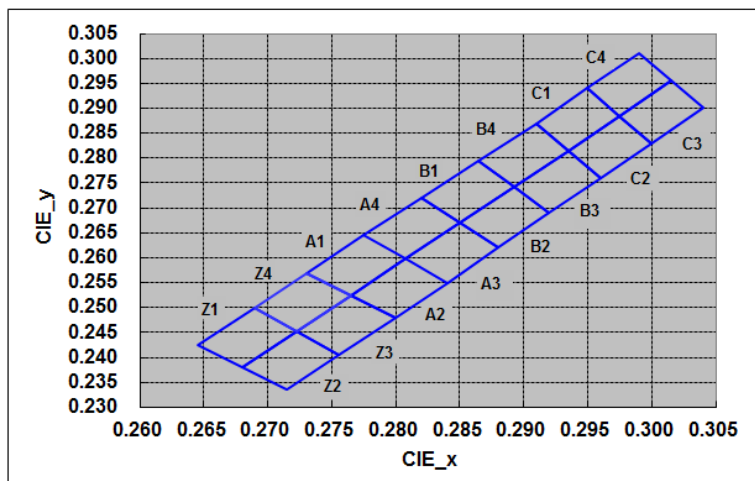

Display & Mobile LTW-206DCG-TMS

Typical Electrical / Optical Characteristics Curves (25°C Ambient Temperature Unless Otherwise Noted)

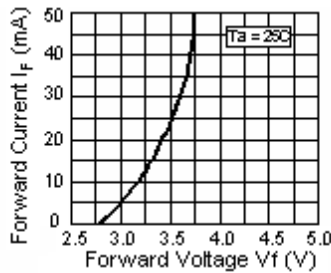
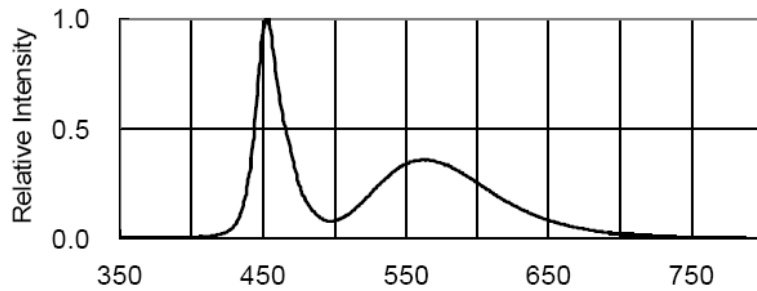

Fig.2 Forward Current vs. Forward Voltage

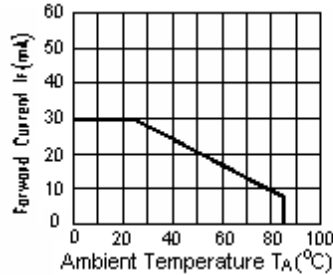

Fig.3 Forward Current Derating Curve

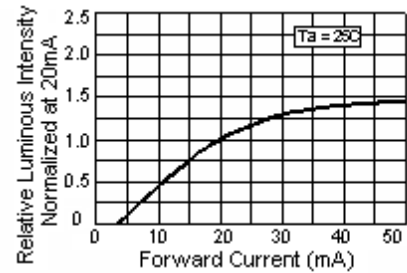

Fig.4 Relative Luminous Intensity vs. Forward Current

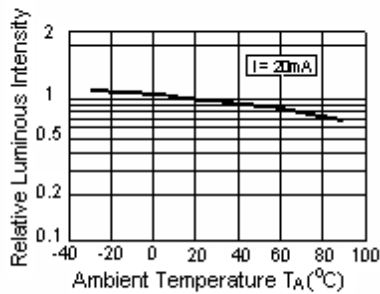

Fig.5 Luminous Intensity vs. Ambient Temperature

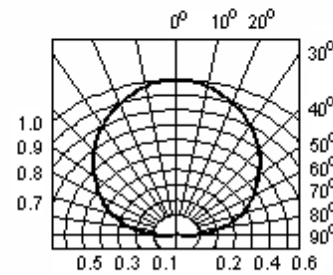

Fig.6 Spatial Distribution

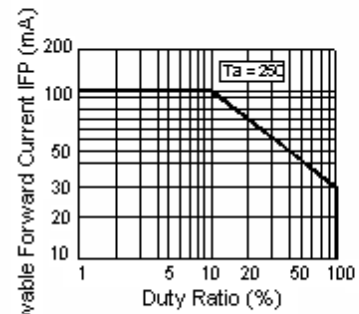

Fig.7 Duty Ratio vs. Allowable Forward Current

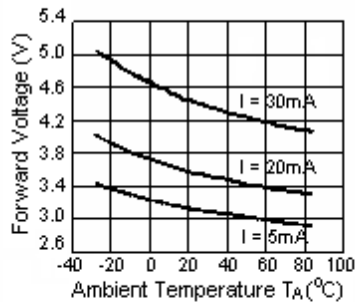

Fig.8 Ambient Temperature vs. Forward Voltage

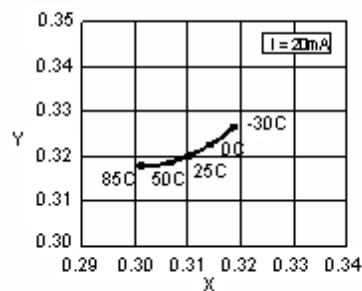

Fig.9 Ambient Temperature vs. Chromaticity Coordinate

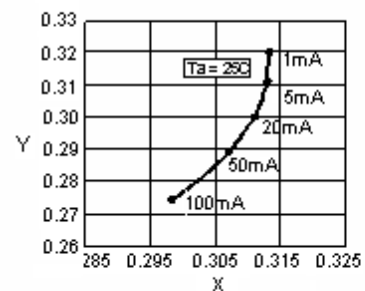
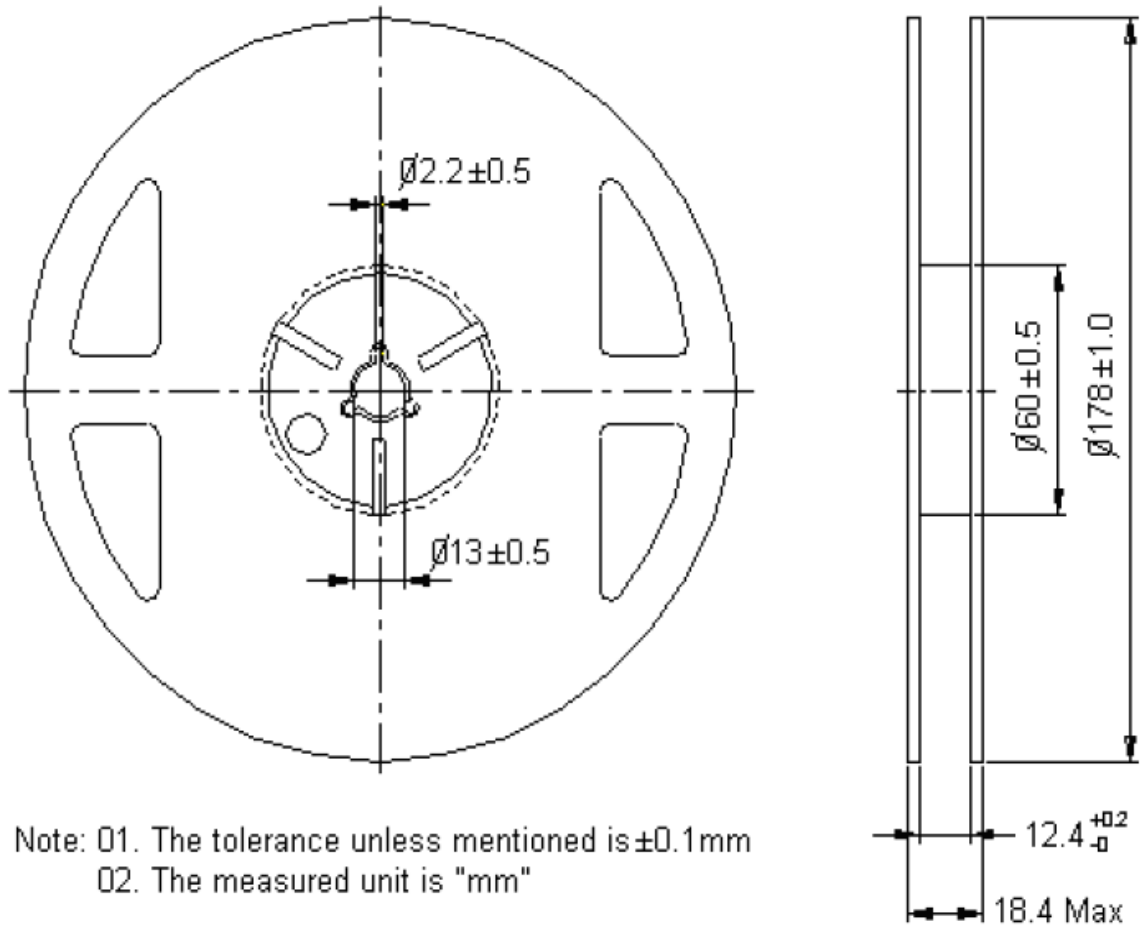

Fig.10 Forward Current vs. Chromaticity Coordinate

**Display & Mobile
LTW-206DCG-TMS**

Package Dimensions of Reel



Note: 01. The tolerance unless mentioned is $\pm 0.1 \text{ mm}$
02. The measured unit is "mm"

Notes:

1. Empty component pockets sealed with top cover tape.
2. 7 inch reel- maximum 2000 pieces per reel.
3. Minimum packing quantity is 500 pieces for remainders.
4. The maximum number of consecutive missing lamps is two.
5. In accordance with EIA-481-1-B specifications.

Display & Mobile LTW-206DCG-TMS

CAUTIONS

1. Application

The LEDs described here are intended to be used for ordinary electronic equipment (such as office equipment, communication equipment and household applications). Consult Liteon's Sales in advance for information on applications in which exceptional reliability is required, particularly when the failure or malfunction of the LEDs may directly jeopardize life or health (such as in aviation, transportation, traffic control equipment, medical and life support systems and safety devices).

2. Storage

This product is qualified as Moisture sensitive Level 3 per JEDEC J-STD-020 Precaution when handling this moisture sensitive product is important to ensure the reliability of the product.

The package is sealed:

The LEDs should be stored at 30°C or less and 90%RH or less. And the LEDs are limited to use within one year, while the LEDs is packed in moisture-proof package with the desiccants inside.

The package is opened:

The LEDs should be stored at 30°C or less and 60%RH or less. Moreover, the LEDs are limited to solder process within 168hrs. If the Humidity Indicator shows the pink color in 10% even higher or exceed the storage limiting time since opened, that we recommended to baking LEDs at 60°C at least 48hrs. To seal the remainder LEDs return to package, it's recommended to be with workable desiccants in original package.

3. Cleaning

Use alcohol-based cleaning solvents such as isopropyl alcohol to clean the LED if necessary.

4. Soldering

Recommended soldering conditions:

Reflow soldering		Soldering iron	
Pre-heat	120~150°C	Temperature	300°C Max.
Pre-heat time	120 sec. Max.	Soldering time	3 sec. Max.
Soldering Temp. Soldering time	260°C Max. 30 sec. Max.		(one time only)

Display & Mobile LTW-206DCG-TMS

5. Drive Method

An LED is a current-operated device. In order to ensure intensity uniformity on multiple LEDs connected in parallel in an application, it is recommended that a current limiting resistor be incorporated in the drive circuit, in series with each LED as shown in Circuit A below.

Circuit model A

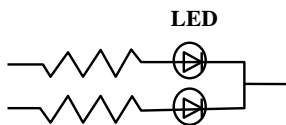

(A) Recommended circuit.

Circuit model B

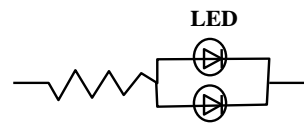

(B) The brightness of each LED might appear different due to the differences in the I-V characteristics of those LEDs.

6. ESD (Electrostatic Discharge)

Static Electricity or power surge will damage the LED.

Suggestions to prevent ESD damage:

- Use of a conductive wrist band or anti-Static glove when handling these LEDs.
- All devices, equipment, and machinery must be properly grounded.
- Work tables, storage racks, etc. should be properly grounded.
- Use ion blower to neutralize the static charge which might have built up on surface of the LED's plastic lens as a result of friction between LEDs during storage and handling.

ESD-damaged LEDs will exhibit abnormal characteristics such as high reverse leakage current, low forward voltage, or " no lightup " at low currents.

To verify for ESD damage, check for " lightup " and V_f of the suspect LEDs at low currents.

The V_f of " good " LEDs should be $>2.0V@0.1mA$ for InGaN product

Display & Mobile LTW-206DCG-TMS

7.1 Reliability Test

Test Item	Test Condition	Note	Number of Damaged
Solderability (Reflow Soldering)	Tsld=245±5°C, 3sec. (Lead Free Solder)	1 time Over 95%	0/30
Thermal Shock	-30°C ~ 85°C 30min. 30min.	100 cycles	0/30
High Temperature Storage	Ta=85°C	1000 hrs.	0/30
Temperature Humidity Storage	Ta=60°C, RH=90%	1000 hrs.	0/30
Steady State Operating Life Condition	Ta=25°C, IF=20mA	1000 hrs.	0/30
Steady State Operating Life of High	Ta=85°C, IF=5mA	500 hrs.	0/30
Steady State Operating Life of High	60°C, RH=90% , IF=20mA	500 hrs.	0/30
Steady State Operating Life of low	Ta=-30°C, IF=20mA	1000 hrs.	0/30

Display & Mobile LTW-206DCG-TMS

7.2 Criteria for Judging the Damage

Item	Symbol	Test Conditions	Criteria for Judgment	
			Min.	Max.
Forward Voltage	VF	IF=20mA	-	U.S.L. × 1.1
Luminous Intensity	IV	IF=20mA	U.S.L. × 0.7	-

8. Others

The appearance and specifications of the product may be modified for improvement without prior notice.

9. Suggested Checking List

Training and Certification

1. Everyone working in a static-safe area is ESD-certified?
2. Training records kept and re-certification dates monitored?

Static-Safe Workstation & Work Areas

1. Static-safe workstation or work-Sreas have ESD signs?
2. All surfaces and objects at all static-safe workstation and within 1 ft measure less than 100V?
3. All ionizer activated, positioned towards the units?
4. Each work surface mats grounding is good?

Personnel Grounding

1. Every person (including visitors) handling ESD sensitive (ESDS) items wear wrist strap, heel strap or conductive shoes with conductive flooring?
2. If conductive footwear used, conductive flooring also present where operator stand or walk?
3. Garments, hairs or anything closer than 1 ft to ESD items measure less than 100V*?
4. Every wrist strap or heel strap/conductive shoes checked daily and result recorded for all DLs?
5. All wrist strap or heel strap checkers calibration up to date?

Note: *50V for Blue LED.

Device Handling

1. Every ESDS items identified by EIA-471 labels on item or packaging?
2. All ESDS items completely inside properly closed static-shielding containers when not at static-safe workstation?
3. No static charge generators (e.g. plastics) inside shielding containers with ESDS items?
4. All flexible conductive and dissipative package materials inspected before reuse or recycle?

Others

1. Audit result reported to entity ESD control coordinator?
2. Corrective action from previous audits completed?
3. Are audit records complete and on file?

