



LED Display Product Data Sheet LTS-5501E

Spec No.: DS30-2000-337

Effective Date: 11/09/2000

Revision: -

LITE-ON DCC

RELEASE

BNS-OD-FC001/A4

FEATURES

- * 0.56 INCH (14.22 mm) DIGIT HEIGHT.
- * CONTINUOUS UNIFORM SEGMENTS.
- * LOW POWER REQUIREMENT.
- * EXCELLENT CHARACTERS APPEARANCE.
- * HIGH BRIGHTNESS & HIGH CONTRAST.
- * WIDE VIEWING ANGLE.
- * SOLID STATE RELIABILITY.
- * CATEGORIZED FOR LUMINOUS INTENSITY.

DESCRIPTION

The LTS-5501E is a 0.56 inch (14.22 mm) digit height single digit display. This device utilizes red orange LED chips which are made from GaAsP on GaP substrate, and has a gray face and white segments.

DEVICE

| PART NO. | DESCRIPTION |
|-----------------|--------------------|
| RED ORANGE | COMMON ANODE |
| LTS-5501E | RT. HAND DECIMAL |

PACKAGE DIMENSIONS

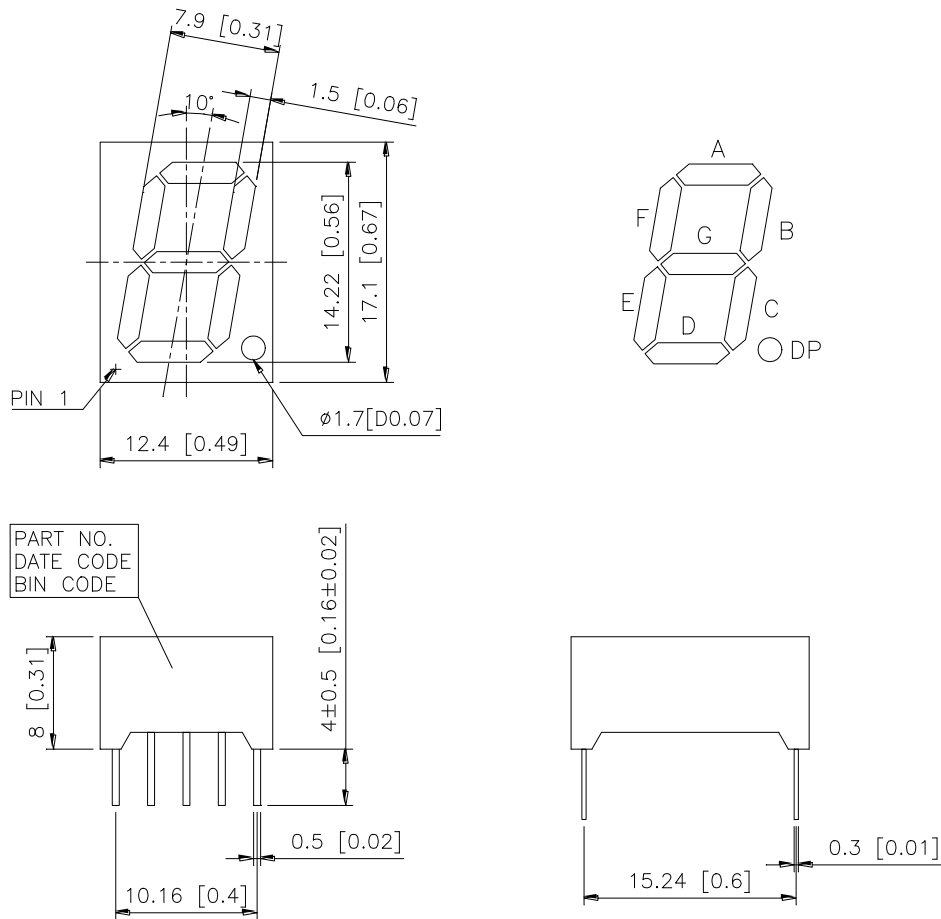

NOTES: All dimensions are in millimeters. Tolerances are ± 0.25 -mm (0.01") unless otherwise noted.

INTERNAL CIRCUIT DIAGRAM

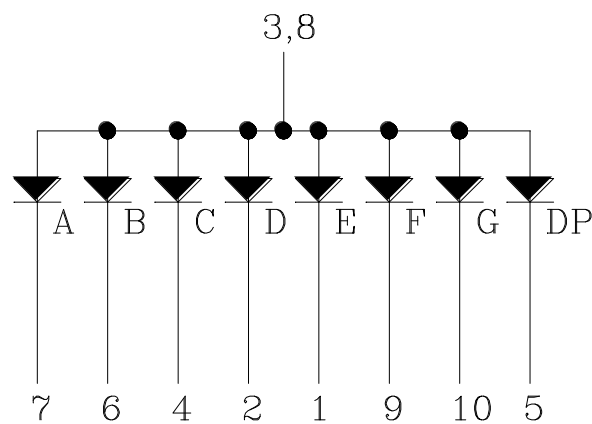

PIN CONNECTION

| No. | CONNECTION |
|------------|-------------------|
| 1 | CATHODE E |
| 2 | CATHODE D |
| 3 | COMMON ANODE |
| 4 | CATHODE C |
| 5 | CATHODE DP. |
| 6 | CATHODE B |
| 7 | CATHODE A |
| 8 | COMMON ANODE |
| 9 | CATHODE F |
| 10 | CATHODE G |

ABSOLUTE MAXIMUM RATING AT Ta=25°C

| PARAMETER | MAXIMUM RATING | UNIT |
|---|----------------|-------------|
| Power Dissipation Per Segment | 75 | mW |
| Peak Forward Current Per Segment (1/10 Duty Cycle, 0.1ms Pulse Width) | 100 | mA |
| Continuous Forward Current Per Segment Derating Linear From 25°C Per Segment | 25 0.33 | mA mA/°C |
| Reverse Voltage Per Segment | 5 | V |
| Operating Temperature Range | -35°C to +85°C | |
| Storage Temperature Range | -35°C to +85°C | |
| Solder Temperature 1/16 inch Below Seating Plane for 3 Seconds at 260°C | | |

ELECTRICAL / OPTICAL CHARACTERISTICS AT Ta=25°C

| PARAMETER | SYMBOL | MIN. | TYP. | MAX. | UNIT | TEST CONDITION |
|-----------------------------------|-------------------|------|------|------|------|----------------------|
| Average Luminous Intensity | I _v | 800 | 2400 | | μcd | I _F =10mA |
| Peak Emission Wavelength | λ _p | | 630 | | nm | I _F =20mA |
| Spectral Line Half-Width | Δλ | | 40 | | nm | I _F =20mA |
| Dominant Wavelength | λ _d | | 621 | | nm | I _F =20mA |
| Forward Voltage Per Segment | V _F | | 2.0 | 2.6 | V | I _F =20mA |
| Reverse Current Per Segment | I _R | | | 100 | μA | V _R =5V |
| Luminous Intensity Matching Ratio | I _v -m | | | 2:1 | | I _F =10mA |

Note: Luminous intensity is measured with a light sensor and filter combination that approximates the CIE (Commission Internationale De L'Eclairage) eye-response curve.

TYPICAL ELECTRICAL / OPTICAL CHARACTERISTIC CURVES

(25°C Ambient Temperature Unless Otherwise Noted)

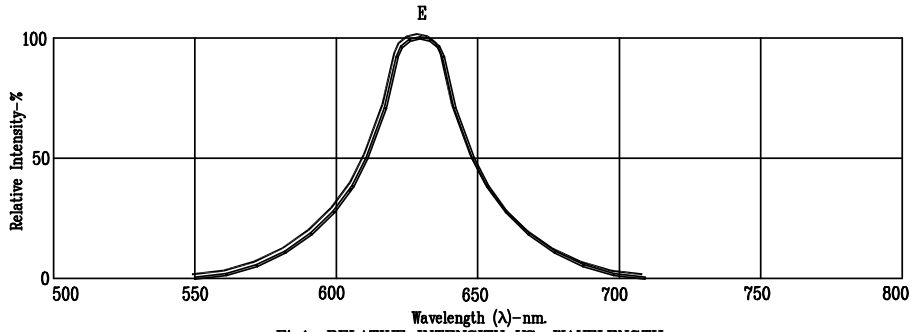

Fig1. RELATIVE INTENSITY VS. WAVELENGTH

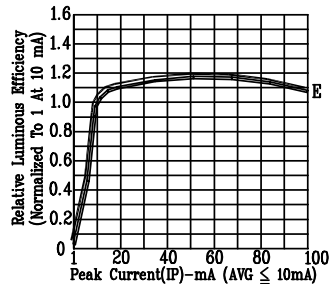

Fig4. RELATIVE LUMINOUS EFFICIENCY (LUMINOUS INTENSITY PER UNIT CURRENT) VS. PEAK CURRENT (REFRESH RATE 1KHz)

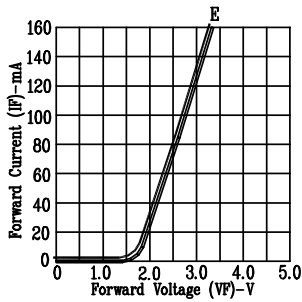

Fig2. FORWARD CURRENT VS. FORWARD VOLTAGE

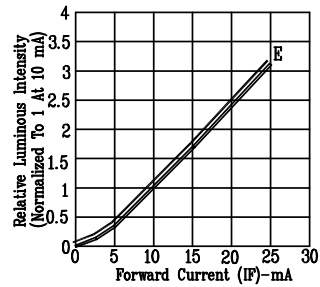

Fig3. RELATIVE LUMINOUS INTENSITY VS. FORWARD CURRENT

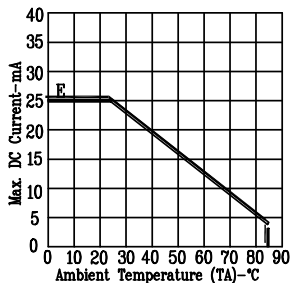

Fig8. MAX ALLOWABLE DC CURRENT VS. AMBIENT TEMPERATURE.

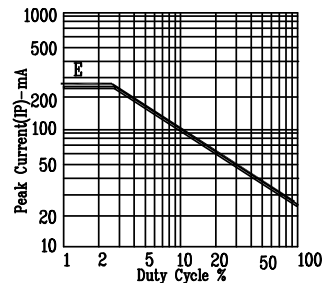

Fig9. MAX PEAK CURRENT VS. DUTY CYCLE % (REFRESH RATE 1KHz)

NOTE: E=RED ORANGE