



LED Display Product Data Sheet LTP-2557JD

Spec No.: DS30-2000-408

Effective Date: 01/09/2001

Revision: -

LITE-ON DCC

RELEASE

BNS-OD-FC001/A4

FEATURES

- * 2.0 INCH (50.80mm) MATRIX HEIGHT.
- * LOW POWER REQUIREMENT.
- * SINGLE PLANE, WIDE VIEWING ANGLE
- * SOLID STATE RELIABILITY.
- * 5x7 ARRAY WITH X-Y SELECT.
- * COMPATIBLE WITH USASCLL AND EBCDIC CODES.
- * STACKABLE HORIZONTALLY.
- * CATEGORIZED FOR LUMINOUS INTENSITY.

DESCRIPTION

The LTP-2557JD is a 2.0inch (50.80mm) matrix height 5x7 dot matrix display. This device utilizes AllnGaP Hi.-Eff. Red LED chips, which are made from AllnGaP on a non-transparent GaAs substrate, and has a gray face and white dot color.

DEVICE

PART NO.	DESCRIPTION
AllnGaP HI.-EFF. RED	CATHODE COLUMN
LTP-2557JD	ANODE ROW

PACKAGE DIMENSIONS

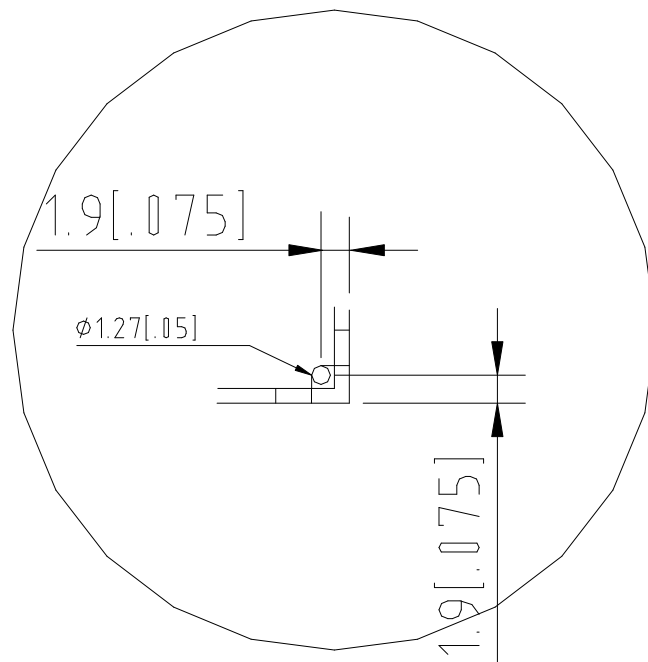
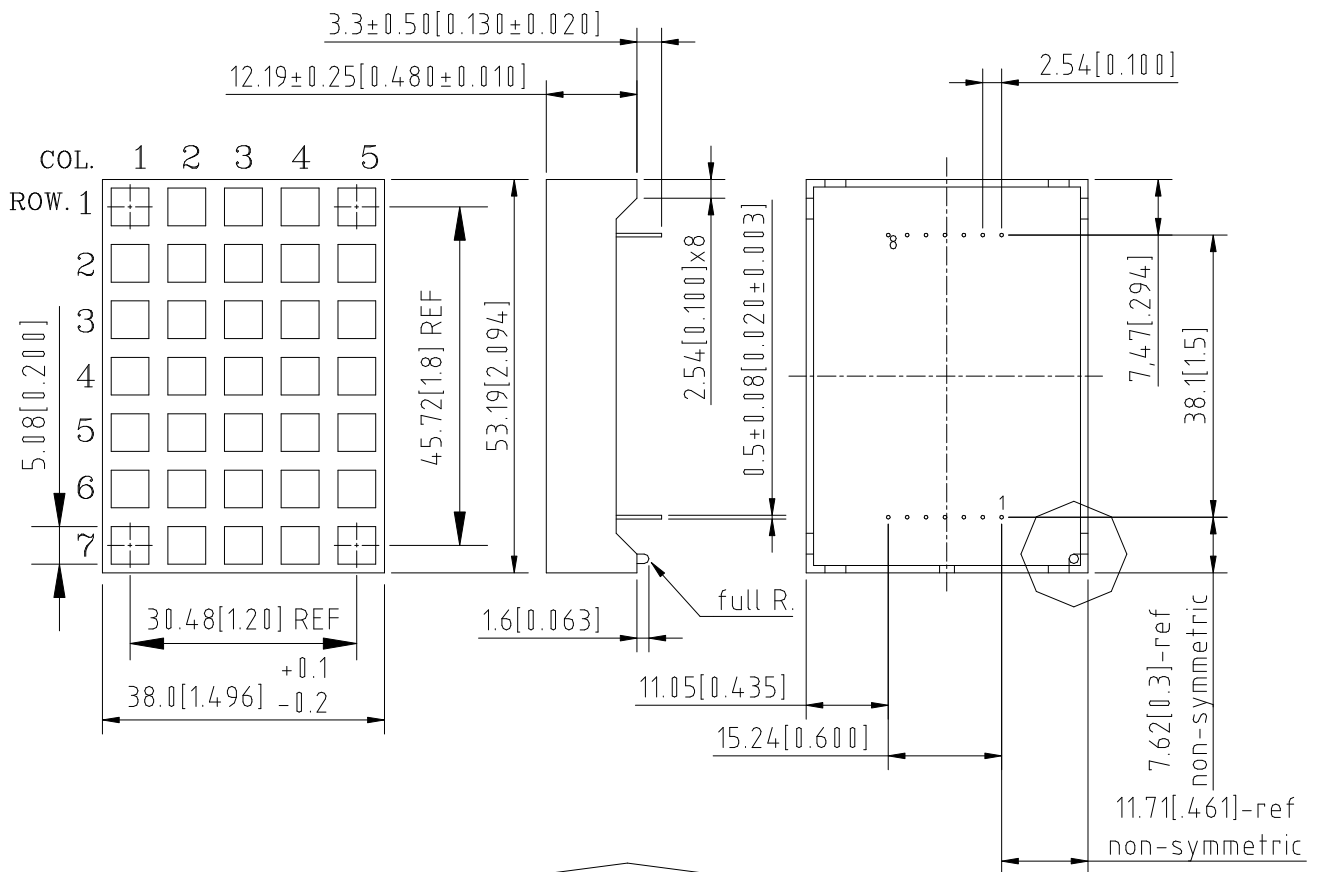

Detail A

NOTES: All dimensions are in millimeters. Tolerances are ± 0.25 mm (0.01") unless otherwise noted.

INTERNAL CIRCUIT DIAGRAM

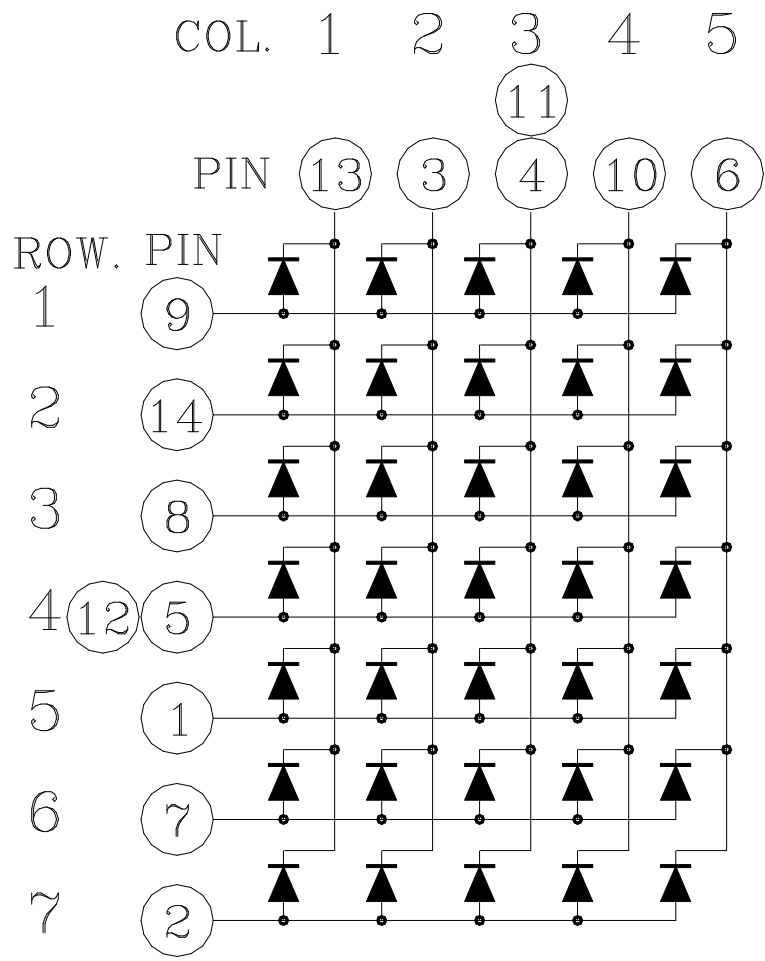

PIN CONNECTION

No.	CONNECTION
1	ANODE ROW 5
2	ANODE ROW 7
3	CATHODE COLUMN 2
4	CATHODE COLUMN 3
5	ANODE ROW 4
6	CATHODE COLUMN 5
7	ANODE ROW 6
8	ANODE ROW 3
9	ANODE ROW 1
10	CATHODE COLUMN 4
11	CATHODE COLUMN 3
12	ANODE ROW 4
13	CATHODE COLUMN 1
14	ANODE ROW 2

ABSOLUTE MAXIMUM RATING AT T_A=25°C

PARAMETER	MAXIMUM RATING	UNIT
Average Power Dissipation Per Dot	33	mW
Peak Forward Current Per Dot	90	mA
Average Forward Current Per Dot	13	mA
Derating Linear From 25 ⁰ C Per Dot	0.17	mA/ ⁰ C
Reverse Voltage Per Dot	5	V
Operating Temperature Range	-35 ⁰ C to +85 ⁰ C	
Storage Temperature Range	-35 ⁰ C to +85 ⁰ C	
Solder Temperature 1/16 inch Below Seating Plane for 3 Seconds at 260 ⁰ C		

ELECTRICAL / OPTICAL CHARACTERISTICS AT T_A=25°C

PARAMETER	SYMBOL	MIN.	TYP.	MAX.	UNIT	TEST CONDITION
Average Luminous Intensity	I _v	1300	3000		μcd	I _p =32mA 1/16Duty
Peak Emission Wavelength	λ _p		656		nm	I _F =20mA
Spectral Line Half-Width	Δλ		22		nm	I _F =20mA
Dominant Wavelength	λ _d		640		nm	I _F =20mA
Forward Voltage any Dot	V _F		2.1	2.6	V	I _F =20mA
Reverse Current any Dot	I _R			100	μA	V _R =5V
Luminous Intensity Matching Ratio	I _v -m			2:1		I _p =32mA 1/16Duty

Note: Luminous intensity is measured with a light sensor and filter combination that approximates the CIE (Commision Internationale De L'Eclairage) eye-response curve.

TYPICAL ELECTRICAL / OPTICAL CHARACTERISTIC CURVES

(25°C Ambient Temperature Unless Otherwise Noted)

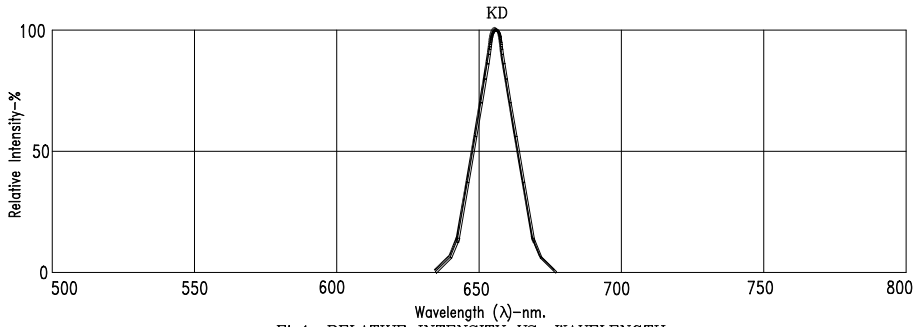

Fig1. RELATIVE INTENSITY VS. WAVELENGTH

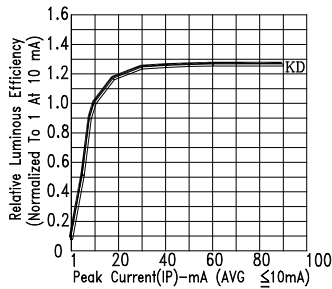

Fig2. RELATIVE LUMINOUS EFFICIENCY (LUMINOUS INTENSITY PER UNIT CURRENT) VS. PEAK CURRENT

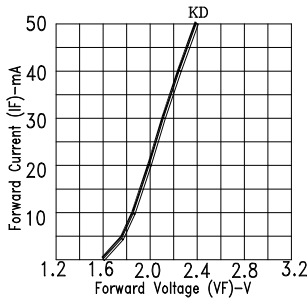

Fig3. FORWARD CURRENT VS. FORWARD VOLTAGE

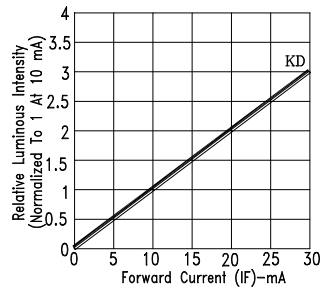

Fig4. RELATIVE LUMINOUS INTENSITY VS. FORWARD CURRENT

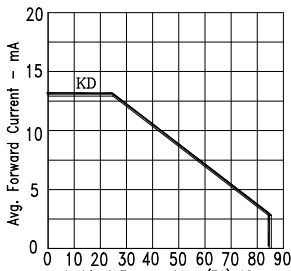

Fig5. MAX. AVERAGE FORWARD CURRENT VS. AMBIENT TEMPERATURE.

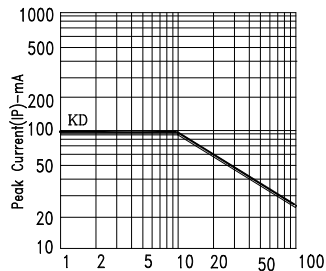

Fig6. MAX. PEAK CURRENT VS. DUTY CYCLE % (REFRESH RATE 1KHz)

NOTE : KD=AlInGaP HL-EFF. RED