



# LED Display Product Data Sheet LTS-2301AJR

Spec No.: DS30-2001-028

Effective Date: 02/27/2001

Revision: -

**LITE-ON DCC**

**RELEASE**

BNS-OD-FC001/A4

**FEATURES**

- \* 0.28-inch (7.0-mm) DIGIT HEIGHT.
- \* CONTINUOUS UNIFORM SEGMENTS.
- \* LOW POWER REQUIREMENT.
- \* EXCELLENT CHARACTERS APPEARANCE.
- \* HIGH BRIGHTNESS & HIGH CONTRAST.
- \* WIDE VIEWING ANGLE.
- \* SOLID STATE RELIABILITY.
- \* CATEGORIZED FOR LUMINOUS INTENSITY.

**DESCRIPTION**

The LTS-2301AJR is a 0.28-inch (7.0-mm) digit height single digit seven-segment display. This device utilizes AlInGaP super red LED chips, which are made from AlInGaP on a transparent GaAs substrate, and has a gray face and white segments.

**DEVICE**

<b>PART NO.</b>	<b>DESCRIPTION</b>
AlInGaP Super RED	Common Cathode
LTS-2301AJR	Rt. Hand Decimal

## PACKAGE DIMENSIONS

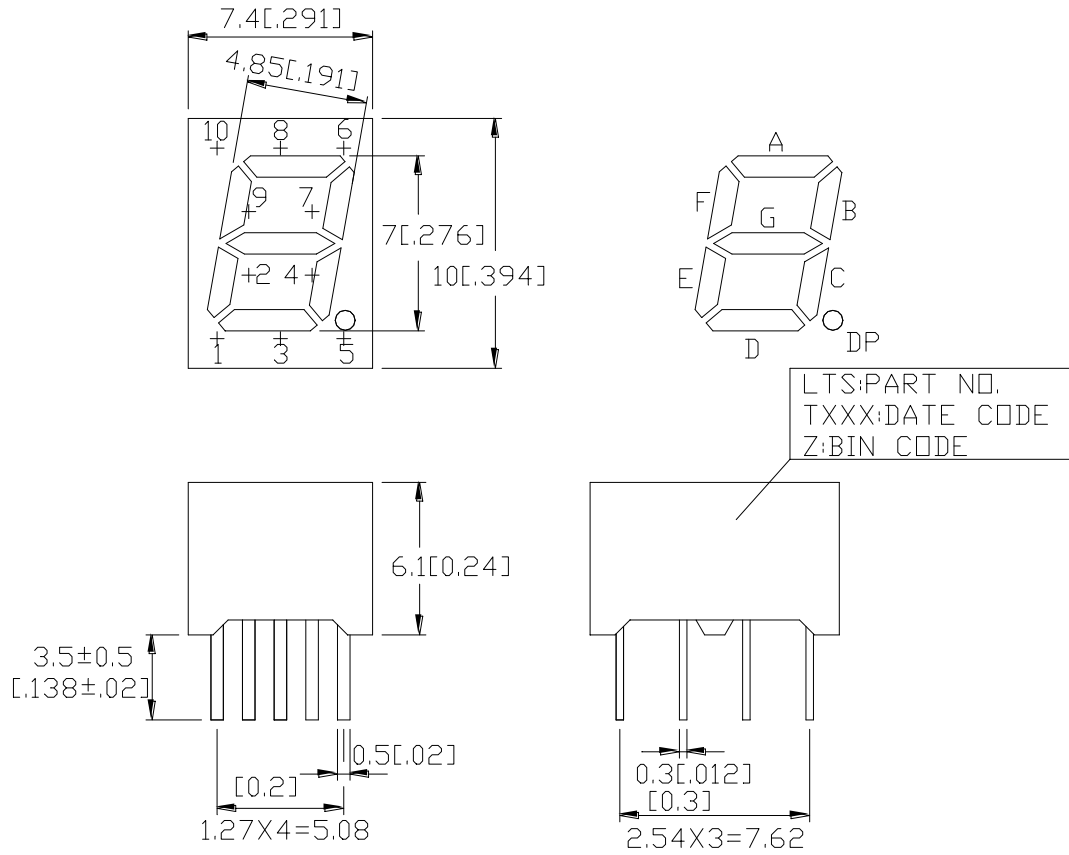

NOTES: All dimensions are in millimeters. Tolerances are ± 0.25 mm (0.01") unless otherwise noted.

## INTERNAL CIRCUIT DIAGRAM

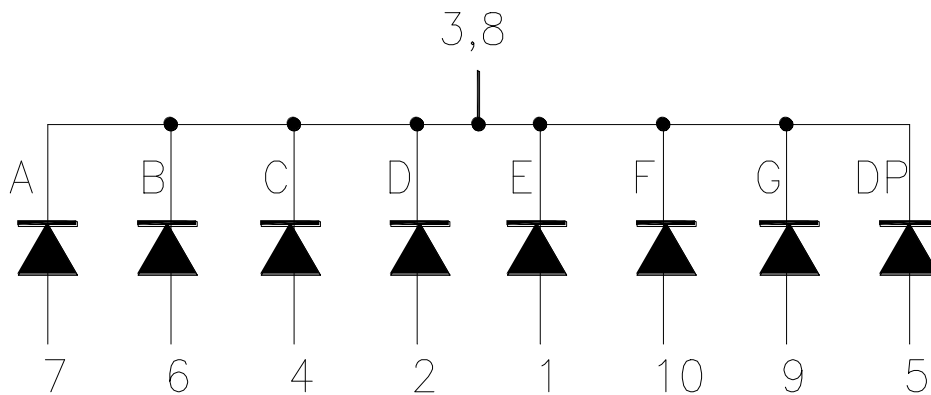

**PIN CONNECTION**

<b>No.</b>	<b>CONNECTION</b>
1	ANODE E
2	ANODE D
3	COMMON CATHODE
4	ANODE C
5	ANODE D.P.
6	ANODE B
7	ANODE A
8	COMMON CATHODE
9	ANODE G
10	ANODE F

**ABSOLUTE MAXIMUM RATING AT T<sub>A</sub>=25°C**

PARAMETER	MAXIMUM RATING	UNIT
Power Dissipation Per Segment	70	mW
Peak Forward Current Per Segment ( 1/10 Duty Cycle, 0.1ms Pulse Width )	90	mA
Continuous Forward Current Per Segment	25	mA
Derating Linear From 25°C Per Segment	0.33	mA/°C
Reverse Voltage Per Segment	5	V
Operating Temperature Range	-35°C to +85°C	
Storage Temperature Range	-35°C to +85°C	
Solder Temperature: max 260°C for max 3sec at 1.6mm below seating plane.		

**ELECTRICAL / OPTICAL CHARACTERISTICS AT T<sub>A</sub>=25°C**

PARAMETER	SYMBOL	MIN.	TYP.	MAX.	UNIT	TEST CONDITION
Average Luminous Intensity	I <sub>v</sub>	200	480		μcd	I <sub>F</sub> =1mA
Peak Emission Wavelength	λ <sub>p</sub>		639		nm	I <sub>F</sub> =20mA
Spectral Line Half-Width	Δλ		20		nm	I <sub>F</sub> =20mA
Dominant Wavelength	λ <sub>d</sub>		631		nm	I <sub>F</sub> =20mA
Forward Voltage Per Segment	V <sub>F</sub>		2.0	2.6	V	I <sub>F</sub> =20mA
Reverse Current Per Segment	I <sub>R</sub>			100	μA	V <sub>R</sub> =5V
Luminous Intensity Matching Ratio	I <sub>v</sub> -m			2:1		I <sub>F</sub> =1mA

Note: Luminous intensity is measured with a light sensor and filter combination that approximates the CIE (commission international DE L'clairage) eye-response curve.

## TYPICAL ELECTRICAL / OPTICAL CHARACTERISTIC CURVES

(25°C Ambient Temperature Unless Otherwise Noted)

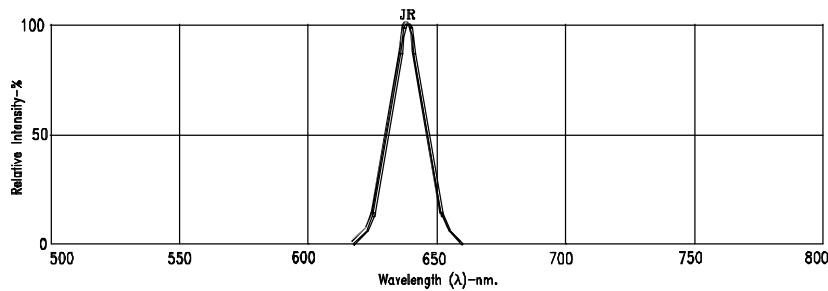

Fig1. RELATIVE INTENSITY VS WAVELENGTH

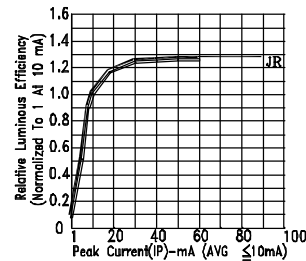

Fig2. RELATIVE LUMINOUS EFFICIENCY (LUMINOUS INTENSITY PER UNIT CURRENT) VS. PEAK CURRENT

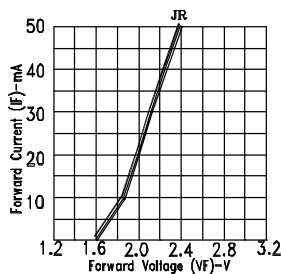

Fig3. FORWARD CURRENT VS. FORWARD VOLTAGE

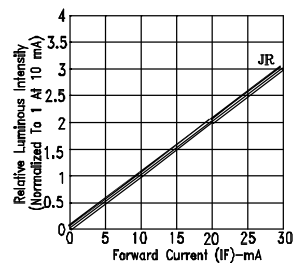

Fig4. RELATIVE LUMINOUS INTENSITY VS. FORWARD CURRENT

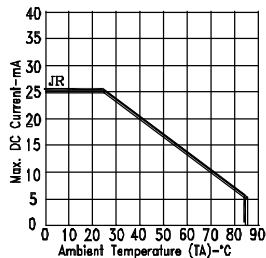

Fig5. MAX ALLOWABLE DC CURRENT VS. AMBIENT TEMPERATURE.

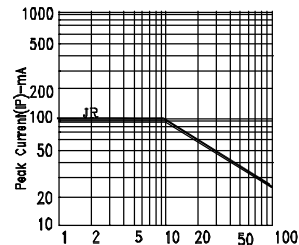

Fig6. MAX PEAK CURRENT VS. DUTY CYCLE % (REFRESH RATE 1KHz)

NOTE : JR=AlInGaP SUPER RED