



LED Display Product Data Sheet LTP-22801JD

Spec No.: DS30-2001-330

Effective Date: 11/27/2001

Revision: -

LITE-ON DCC

RELEASE

BNS-OD-FC001/A4

FEATURES

- * 2.24 inch (57 mm) DIGIT HEIGHT.
- * CONTINUOUS UNIFORM SEGMENTS
- * LOW POWER REQUIREMENT.
- * EXCELLENT CHARACTERS APPEARANCE.
- * HIGH BRIGHTNESS & HIGH CONTRAST.
- * WIDE VIEWING ANGLE.
- * SOLID STATE RELIABILITY.
- * CATEGORIZED FOR LUMINOUS INTENSITY.

DESCRIPTION

The LTP-22801JD is a 2.24 inch (57 mm) digit height single digit 17-segment alphanumeric display. This device utilizes AlInGaP Hyper Red LED chips, which are made from AlInGaP on a non-transparent GaAs substrate, and has a black face and white segments.

DEVICE

PART NO.	DESCRIPTION
AlInGaP Hyper Red	Common Anode
LTP-22801JD	Rt. Hand Decimal

PACKAGE DIMENSIONS

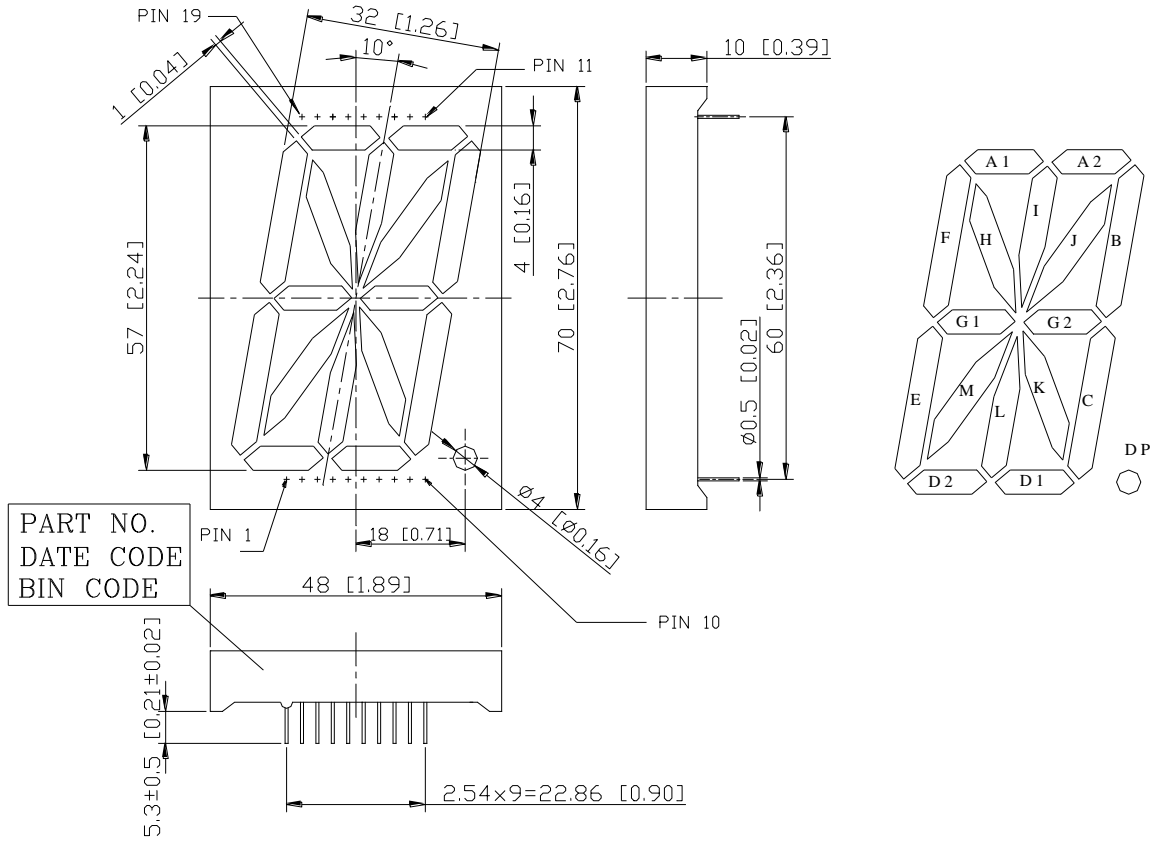

NOTES: All dimensions are in millimeters. Tolerances are ± 0.25 -mm (0.01") unless otherwise noted.

INTERNAL CIRCUIT DIAGRAM

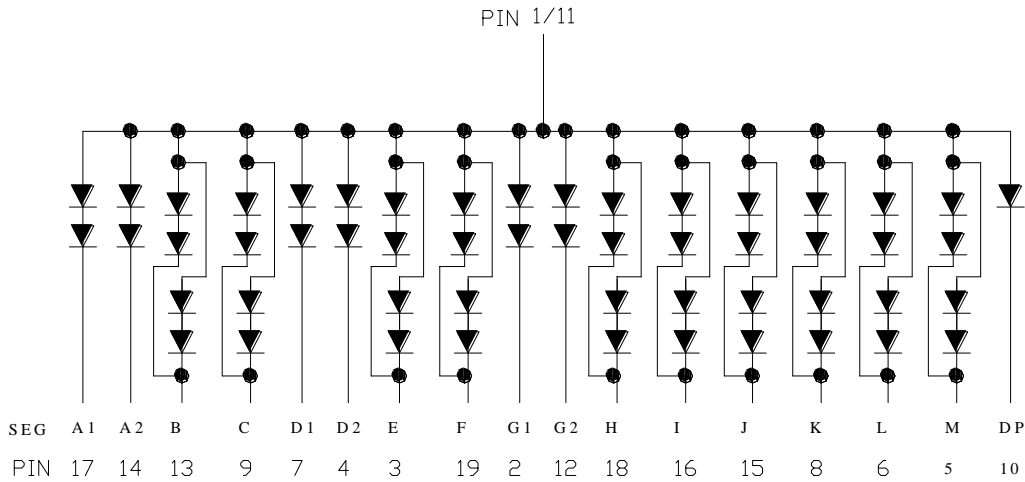

PIN CONNECTION

No.	CONNECTION
1	COMMON ANODE
2	CATHODE G1
3	CATHODE E
4	CATHODE D2
5	CATHODE M
6	CATHODE L
7	CATHODE D1
8	CATHODE K
9	CATHODE C
10	CATHODE DP
11	COMMON ANODE
12	CATHODE G2
13	CATHODE B
14	CATHODE A2
15	CATHODE J
16	CATHODE I
17	CATHODE A1
18	CATHODE H
19	CATHODE F

ABSOLUTE MAXIMUM RATING AT Ta=25°C

PARAMETER	MAXIMUM RATING	UNIT
Power Dissipation Per Segment	134 (268)	mW
Peak Forward Current Per Segment (1/10 Duty Cycle, 1.0ms Pulse Width)	90 (180)	mA
Continuous Forward Current Per Segment Derating Linear From 25°C Per Segment	24 (48) 0.31	mA mA/°C
Reverse Voltage Per Segment	10	V
Operating Temperature Range	-35°C to +85°C	
Storage Temperature Range	-35°C to +85°C	
Solder Temperature: max 260°C for max 3sec at 1.6mm[1/16inch] below seating plane.		

ELECTRICAL / OPTICAL CHARACTERISTICS AT Ta=25°C

PARAMETER	SYMBOL	MIN.	TYP.	MAX.	UNIT	TEST CONDITION
Average Luminous Intensity	I _v		31.2 (54.6)		mcd	I _F =20mA (I _F =40mA)
Peak Emission Wavelength	λ _p		650		nm	I _F =20mA (40mA)
Spectral Line Half-Width	Δλ		20		nm	I _F =20mA (40mA)
Dominant Wavelength	λ _d		639		nm	I _F =20mA (40mA)
Forward Voltage Per Segment	V _F		4.2	5.2	V	I _F =20mA (40mA)
Reverse Current Per Segment	I _R			100 (200)	μA	V _R =10V
Luminous Intensity Matching Ratio	I _v -m			2:1		I _F =20mA (40mA)

Note: Luminous intensity is measured with a light sensor and filter combination that approximates the CIE (Commission Internationale De L'Eclairage) eye-response curve.

TYPICAL ELECTRICAL / OPTICAL CHARACTERISTIC CURVES

(25°C Ambient Temperature Unless Otherwise Noted)

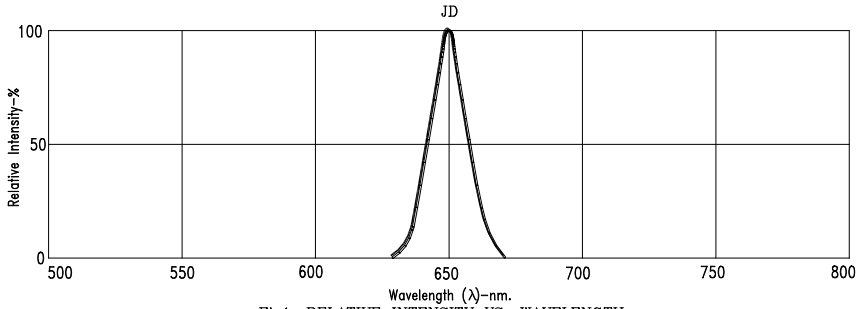

Fig1. RELATIVE INTENSITY VS. WAVELENGTH

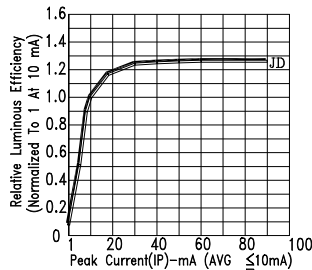

Fig2. RELATIVE LUMINOUS EFFICIENCY (LUMINOUS INTENSITY PER UNIT CURRENT) VS. PEAK CURRENT

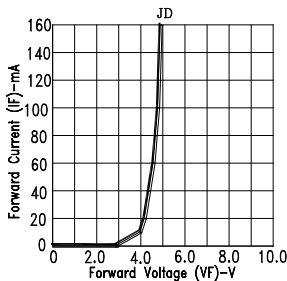

Fig3. FORWARD CURRENT VS. FORWARD VOLTAGE

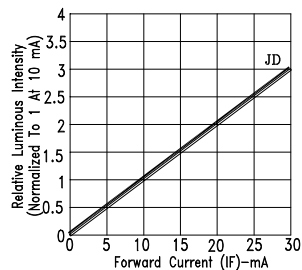

Fig4. RELATIVE LUMINOUS INTENSITY VS. FORWARD CURRENT

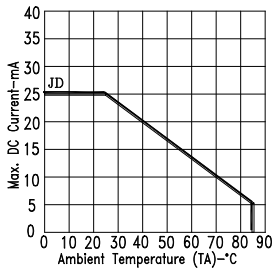

Fig5. MAX. ALLOWABLE DC CURRENT VS. AMBIENT TEMPERATURE.

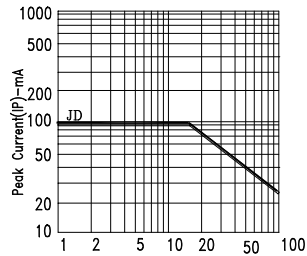

Fig6. MAX. PEAK CURRENT VS. DUTY CYCLE % (REFRESH RATE 1KHz)

NOTE : JD=AlInGaP HYPER RED

Note : Dual chip dice.