



LED Display Product Data Sheet LTP-3862JR

Spec No.: DS30-2001-480

Effective Date: 08/16/2003

Revision: A

LITE-ON DCC

RELEASE

BNS-OD-FC001/A4

FEATURES

- * 0.3 inch (7.62 mm) DIGIT HEIGHT
- * CONTINUOUS UNIFORM SEGMENTS
- * LOW POWER REQUIREMENT
- * EXCELLENT CHARACTERS APPEARANCE
- * HIGH BRIGHTNESS & HIGH CONTRAST
- * WIDE VIEWING ANGLE
- * SOLID STATE RELIABILITY
- * CATEGORIZED FOR LUMINOUS INTENSITY

DESCRIPTION

The LTP-3862JR is a 0.3 inch (7.62 mm) digit height dual digit 17-segment alphanumeric display. This device uses AS-AlInGaP RED SUPER LED chips (AlInGaP epi on GaAs substrate). The display has black face and white segments.

DEVICE

| PART NO. | DESCRIPTION |
|-------------------|------------------------|
| AlInGaP Super Red | Multiplex Common Anode |
| LTP-3862JR | Rt. Hand Decimal |

PACKAGE DIMENSIONS

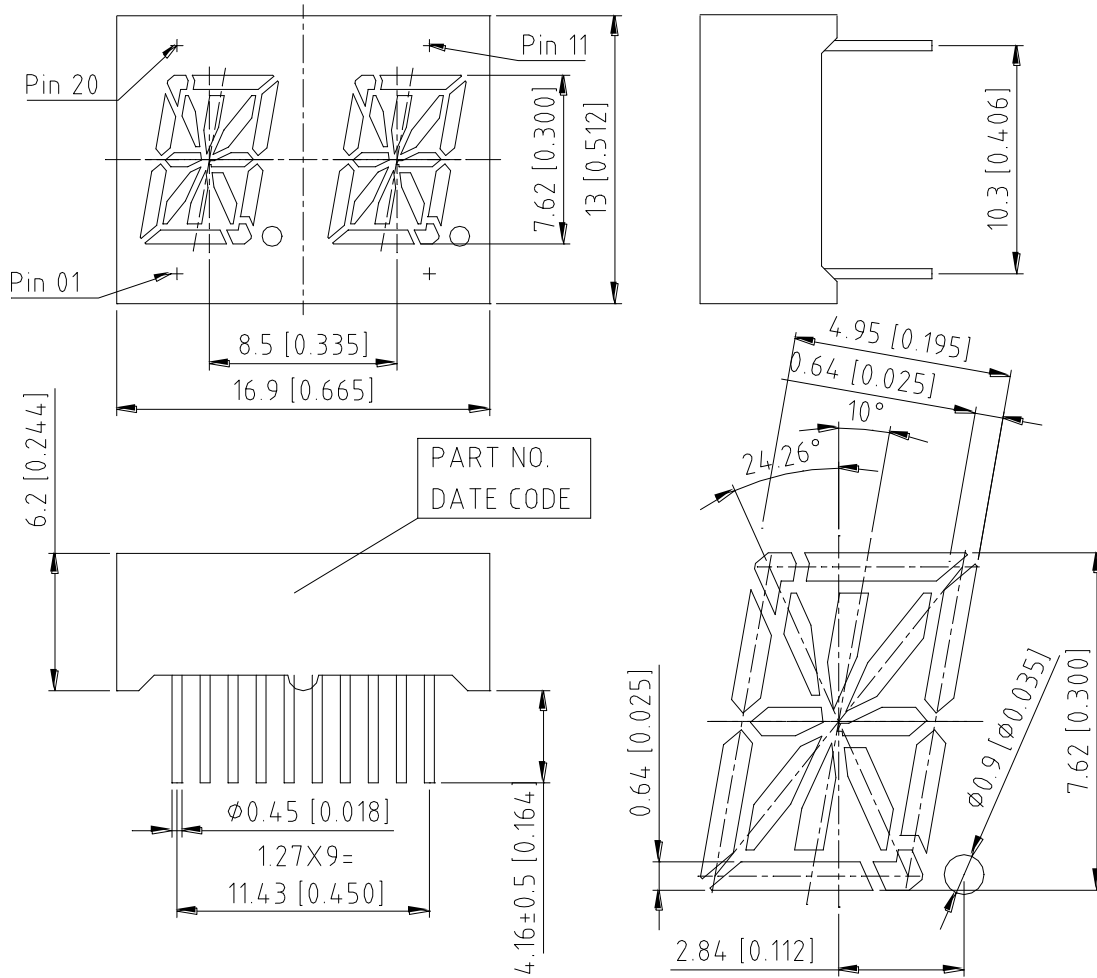

NOTES: All dimensions are in millimeters. Tolerances are ± 0.25mm (0.01“) unless otherwise noted.

INTERNAL CIRCUIT DIAGRAM

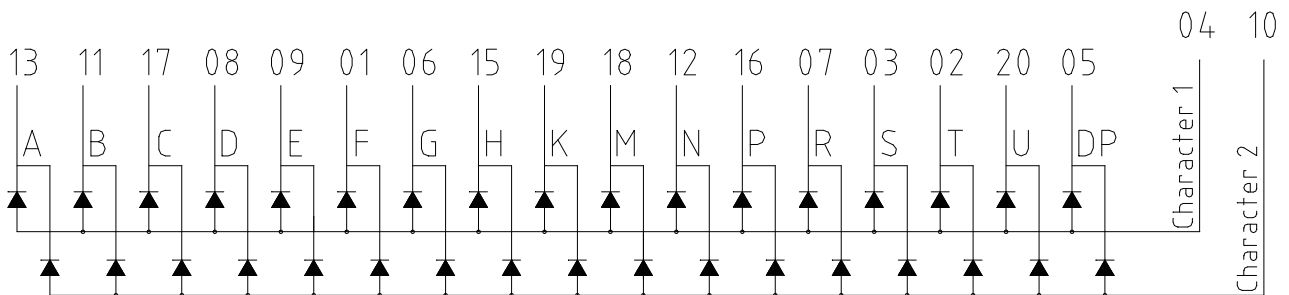

PIN CONNECTION

| No. | CONNECTION |
|------------|------------------------|
| 1 | CATHODE F |
| 2 | CATHODE T |
| 3 | CATHODE S |
| 4 | COMMON ANODE (Digit 1) |
| 5 | CATHODE DP |
| 6 | CATHODE G |
| 7 | CATHODE R |
| 8 | CATHODE D |
| 9 | CATHODE E |
| 10 | COMMON ANODE (Digit 2) |
| 11 | CATHODE B |
| 12 | CATHODE N |
| 13 | CATHODE A |
| 14 | NO CONNECTION |
| 15 | CATHODE H |
| 16 | CATHODE P |
| 17 | CATHODE C |
| 18 | CATHODE M |
| 19 | CATHODE K |
| 20 | CATHODE U |

ABSOLUTE MAXIMUM RATING

| PARAMETER | MAXIMUM RATING | UNIT |
|--|---|--------------------------|
| Power Dissipation Per Segment | 70 | mW |
| Peak Forward Current Per Segment (1/10 Duty Cycle, 0.1ms Pulse Width) | 90 | mA |
| Continuous Forward Current Per Segment Derating Linear From 25 ⁰ C Per Segment | 25 0.33 | mA mA/ ⁰ C |
| Reverse Voltage Per Segment | 8 | V |
| Operating Temperature Range | -35 ⁰ C to +105 ⁰ C | |
| Storage Temperature Range | -35 ⁰ C to +105 ⁰ C | |
| Soldering Conditions : 1/16 inch below seating plane for 3 seconds at 260 ⁰ C | | |

ELECTRICAL / OPTICAL CHARACTERISTICS AT T_A=25⁰C

| PARAMETER | SYMBOL | MIN. | TYP. | MAX. | UNIT | TEST CONDITION |
|--|-------------------|------|------|------|------|----------------------|
| Average Luminous Intensity Per Segment | I _v | 200 | 600 | | μcd | I _F =1mA |
| Peak Emission Wavelength | λ _p | | 639 | | nm | I _F =20mA |
| Spectral Line Half-Width | Δλ | | 20 | | nm | I _F =20mA |
| Dominant Wavelength | λ _d | | 631 | | nm | I _F =20mA |
| Forward Voltage Per Segment | V _F | | 2.0 | 2.6 | V | I _F =20mA |
| Reverse Current Per Segment | I _R | | | 100 | μA | V _R =5V |
| Luminous Intensity Matching Ratio | I _v -m | | | 2:1 | | I _F =1mA |

Note: Luminous intensity is measured with a light sensor and filter combination that approximates the CIE (Commision Internationale De L'Eclairage) eye-response curve.

TYPICAL ELECTRICAL / OPTICAL CHARACTERISTIC CURVES

(25°C Ambient Temperature Unless Otherwise Noted)

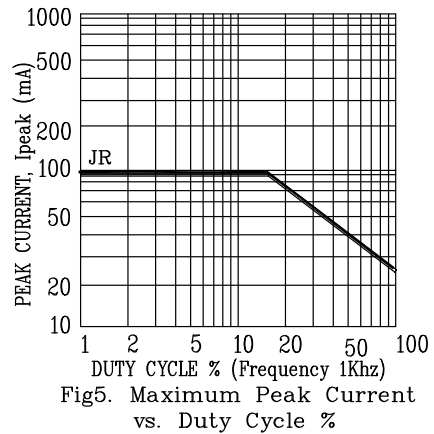
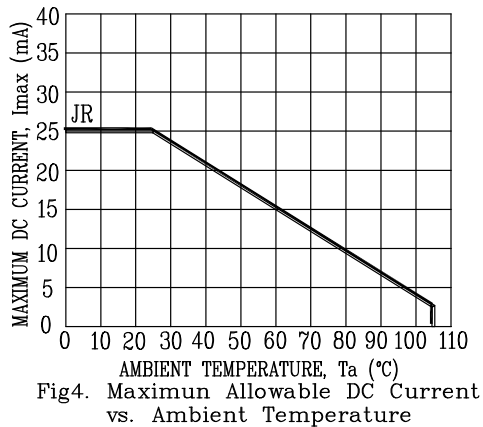
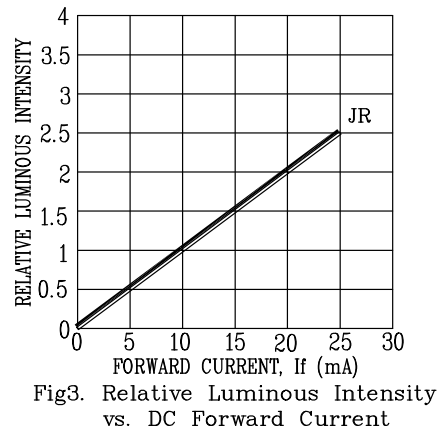
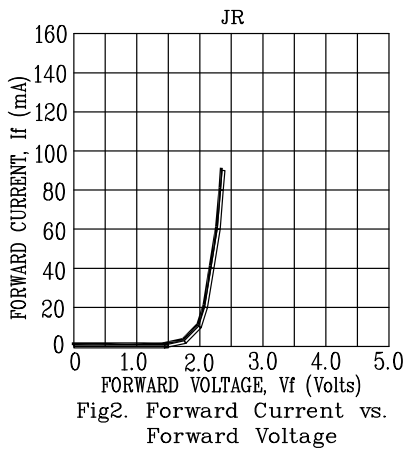
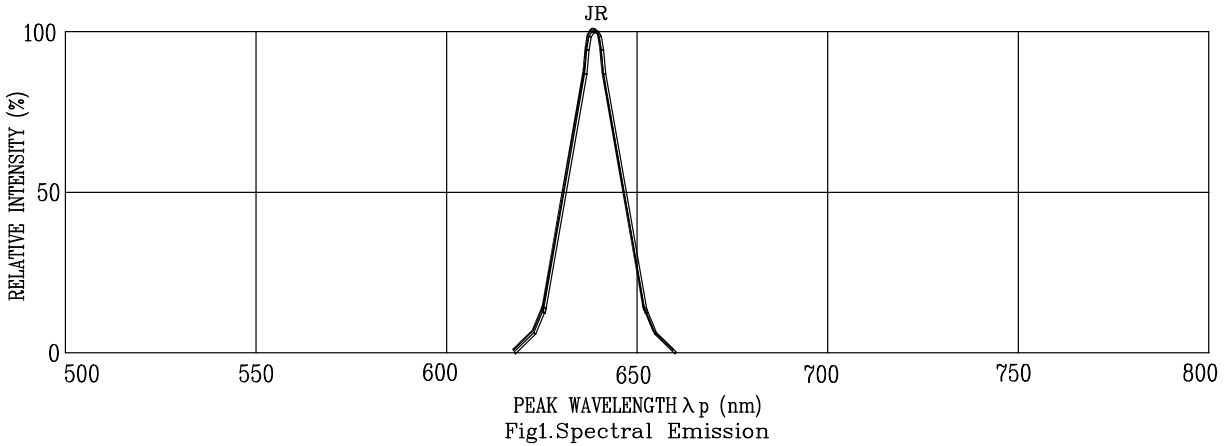

NOTE : JR=AlInGaP SUPER RED