



# LED Display Product Data Sheet LTP-3362JD

Spec No.: DS30-2001-486

Effective Date: 09/16/2003

Revision: A

**LITE-ON DCC**

**RELEASE**

BNS-OD-FC001/A4

**FEATURES**

- \* 0.3 inch (7.62 mm) DIGIT HEIGHT
- \* CONTINUOUS UNIFORM SEGMENTS
- \* LOW POWER REQUIREMENT
- \* EXCELLENT CHARACTERS APPEARANCE
- \* HIGH BRIGHTNESS & HIGH CONTRAST
- \* WIDE VIEWING ANGLE
- \* SOLID STATE RELIABILITY
- \* CATEGORIZED FOR LUMINOUS INTENSITY

**DESCRIPTION**

The LTP-3362JD is a 0.3 inch (7.62 mm) digit height dual digit 17-segment alphanumeric display. This device uses AS-AlInGaP Hyper RED LED chips (AlInGaP on GaAs substrate). The display has black face and white segments.

**DEVICE**

<b>PART NO.</b>	<b>DESCRIPTION</b>
AlInGaP Hyper Red	Multiplex Common Cathode
LTP-3362JD	Rt. Hand Decimal

## PACKAGE DIMENSIONS

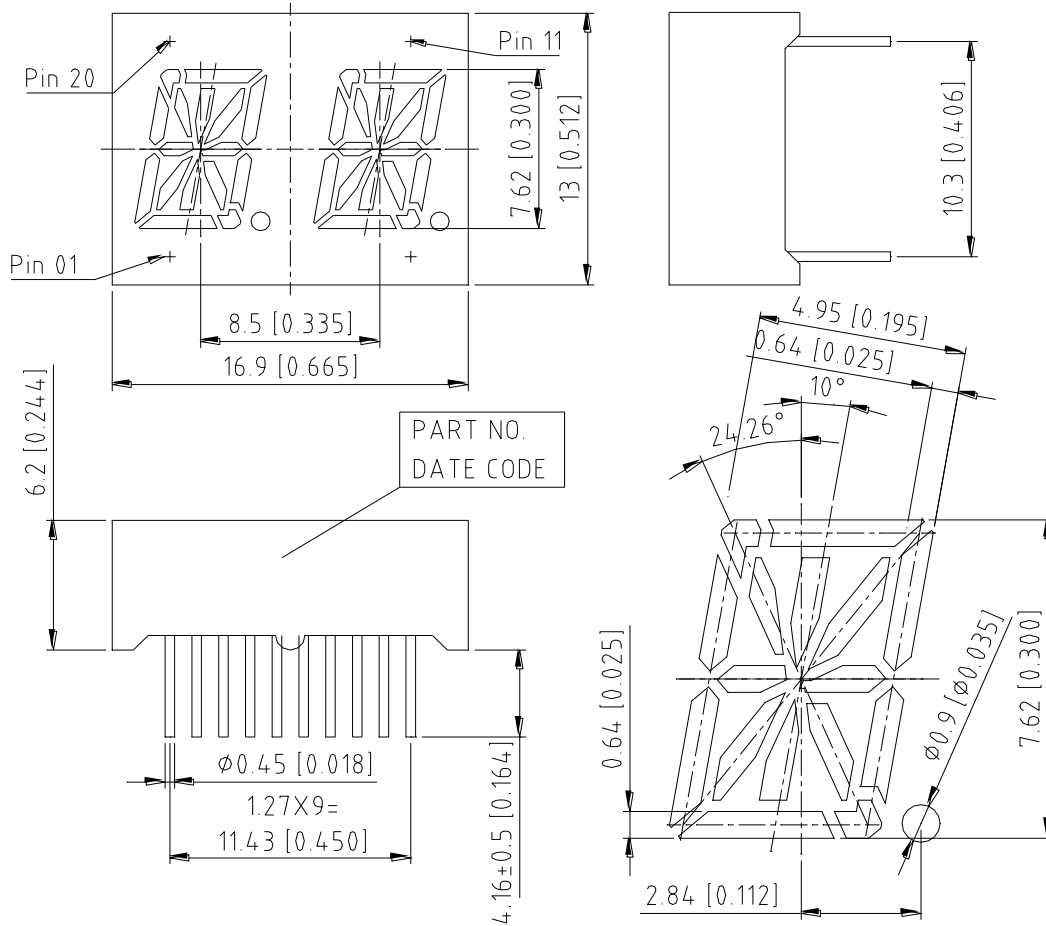

NOTES: All dimensions are in millimeters. Tolerances are  $\pm 0.25\text{mm}$  (0.01") unless otherwise noted.

## INTERNAL CIRCUIT DIAGRAM

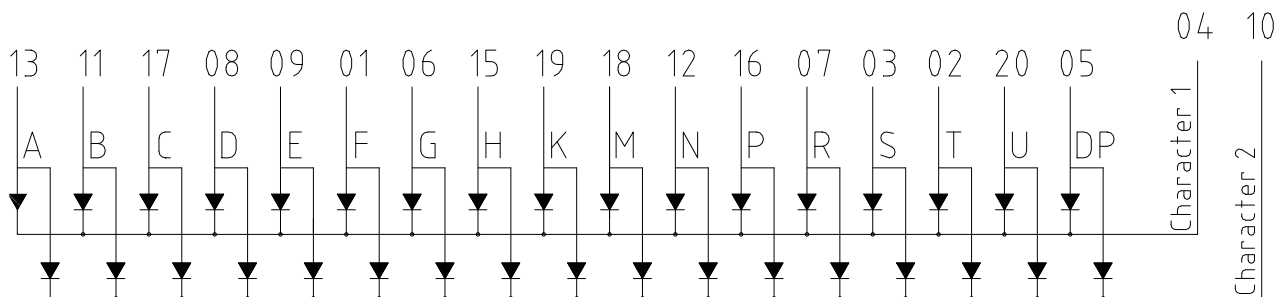

**PIN CONNECTION**

<b>No.</b>	<b>CONNECTION</b>
1	ANODE F
2	ANODE T
3	ANODE S
4	COMMON CATHODE (Digit 1)
5	ANODE DP
6	ANODE G
7	ANODE R
8	ANODE D
9	ANODE E
10	COMMON CATHODE (Digit 2)
11	ANODE B
12	ANODE N
13	ANODE A
14	NO CONNECTION
15	ANODE H
16	ANODE P
17	ANODE C
18	ANODE M
19	ANODE K
20	ANODE U

**ABSOLUTE MAXIMUM RATING**

PARAMETER	MAXIMUM RATING	UNIT
Power Dissipation Per Segment	70	mW
Peak Forward Current Per Segment ( Frequency 1Khz, 10% duty cycle)	90	mA
Continuous Forward Current Per Segment	25	mA
Forward Current Derating from 25 <sup>0</sup> C	0.33	mA/ <sup>0</sup> C
Reverse Voltage Per Segment	5	V
Operating Temperature Range	-35 <sup>0</sup> C to +85 <sup>0</sup> C	
Storage Temperature Range	-35 <sup>0</sup> C to +85 <sup>0</sup> C	
Soldering Conditions : 1/16 inch below seating plane for 3 seconds at 260 <sup>0</sup> C		

**ELECTRICAL / OPTICAL CHARACTERISTICS**

PARAMETER	SYMBOL	MIN.	TYP.	MAX.	UNIT	TEST CONDITION
Average Luminous Intensity Per Segment	I <sub>v</sub>	200	600		μcd	I <sub>F</sub> =1mA
Peak Emission Wavelength	λ <sub>p</sub>		650		nm	I <sub>F</sub> =20mA
Spectral Line Half-Width	Δλ		20		nm	I <sub>F</sub> =20mA
Dominant Wavelength	λ <sub>d</sub>		639		nm	I <sub>F</sub> =20mA
Forward Voltage Per Segment	V <sub>F</sub>		2.0	2.6	V	I <sub>F</sub> =20mA
Reverse Current Per Segment	I <sub>R</sub>			100	μA	V <sub>R</sub> =5V
Luminous Intensity Matching Ratio	I <sub>v</sub> -m			2:1		I <sub>F</sub> =1mA

Note: Luminous intensity is measured with a light sensor and filter combination that approximates the CIE (Commision Internationale De L'Eclairage) eye-response curve.

**TYPICAL ELECTRICAL / OPTICAL CHARACTERISTIC CURVES**

(25°C Ambient Temperature Unless Otherwise Noted)

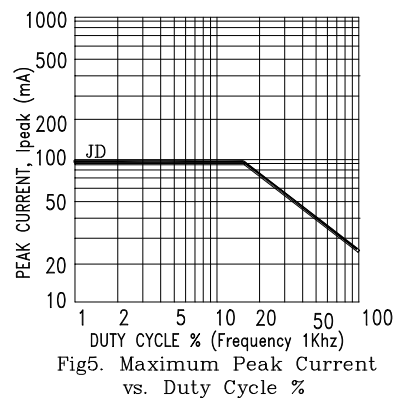
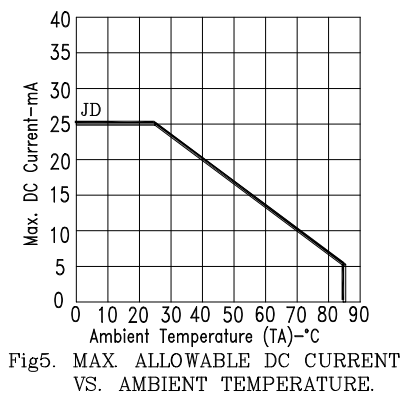
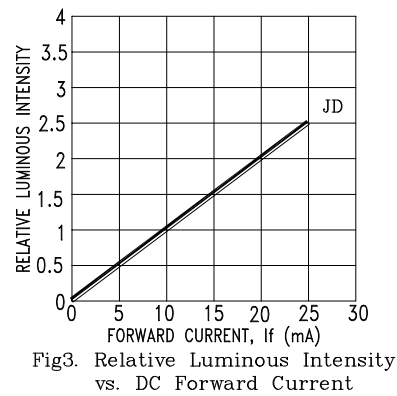
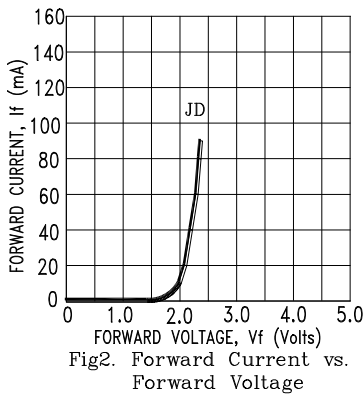
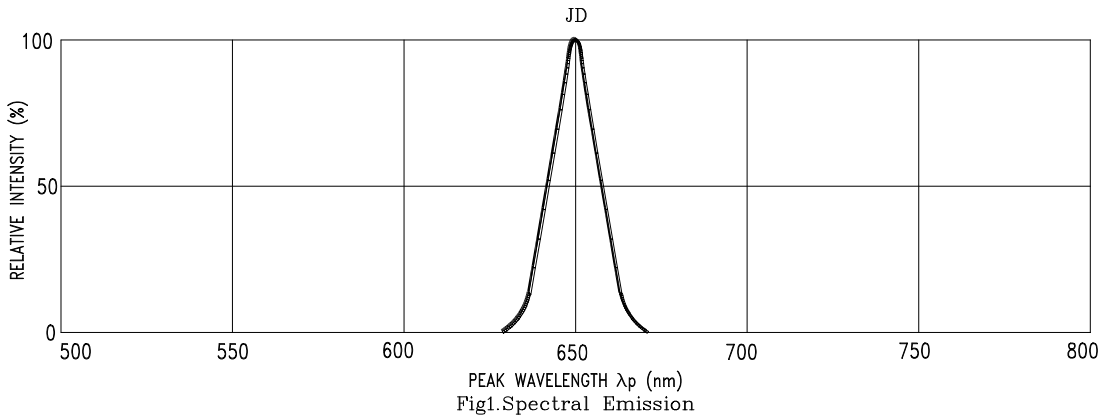

NOTE : JD=AlInGaP HYPER RED