



LED Display Product Data Sheet LSHD-5503

Spec No.: DS30-2002-146

Effective Date: 07/16/2010

Revision: B

LITE-ON DCC

RELEASE

BNS-OD-FC001/A4

FEATURES

- * 0.56 inch (14.22 mm) DIGIT HEIGHT
- * EXCELLENT SEGMENT UNIFORMITY
- * LOW POWER REQUIREMENT
- * HIGH BRIGHTNESS AND HIGH CONTRAST
- * WIDE VIEWING ANGLE
- * SOLID STATE RELIABILITY
- * BINNED FOR LUMINOUS INTENSITY

DESCRIPTION

The LSHD-5503 is a 0.56 inch (14.22 mm) digit height single-digit display. This device uses AS-AlInGaP RED LED chips (AlInGaP epi on GaAs substrate). The display has light gray face and white segments.

DEVICE

PART NO.	DESCRIPTION
AlInGaP RED	Common Cathode
LSHD-5503	Rt. Hand Decimal

PACKAGE DIMENSIONS

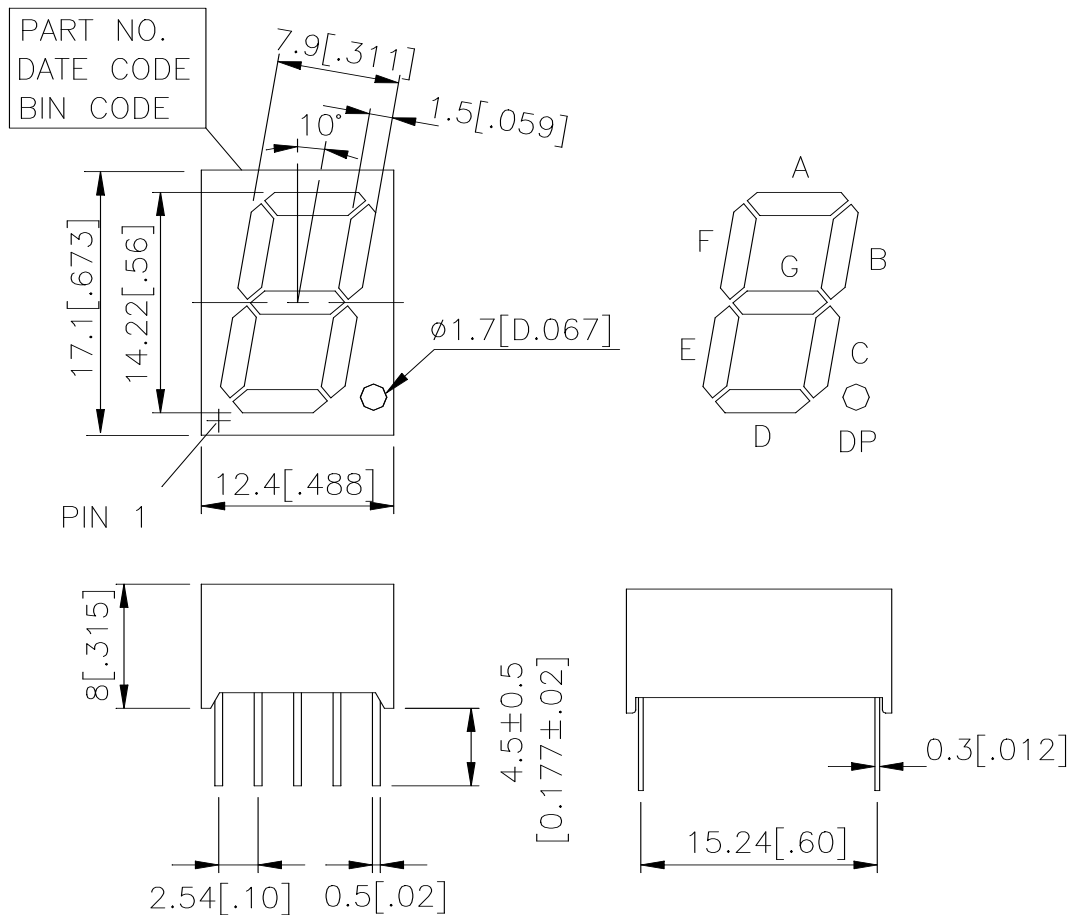

NOTES: All dimensions are in millimeters. Tolerances are ± 0.25mm (0.01") unless otherwise noted.

INTERNAL CIRCUIT DIAGRAM

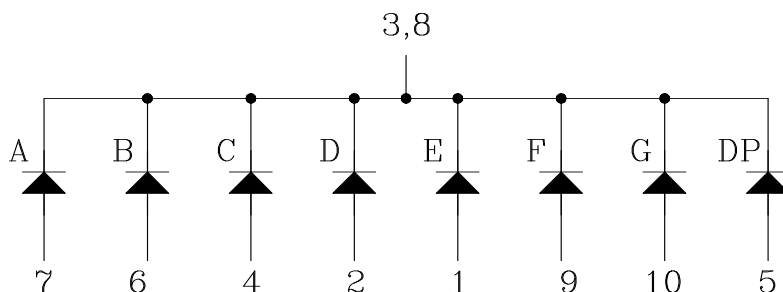

PIN CONNECTION

No.	CONNECTION
1	Anode E
2	Anode D
3	Common Cathode
4	Anode C
5	Anode DP
6	Anode B
7	Anode A
8	Common Cathode
9	Anode F
10	Anode G

ABSOLUTE MAXIMUM RATING AT Ta = 25°C

PARAMETER	MAXIMUM RATING	UNIT
Power Dissipation Per Segment	70	mW
Peak Forward Current Per Segment (Frequency 1Khz, 15% duty cycle)	90	mA
Continuous Forward Current Per Segment	25	mA
Forward Current Derating from 25°C	0.28	mA/°C
Operating Temperature Range	-35°C to +105°C	
Storage Temperature Range	-35°C to +105°C	
Soldering Conditions : 1/16 inch below seating plane for 5 seconds at 260°C		

ELECTRICAL / OPTICAL CHARACTERISTICS AT Ta = 25°C

PARAMETER	SYMBOL	MIN	TYP	MAX	UNIT	TEST CONDITION
Average Luminous Intensity Per Segment	I _v	320 5400	1300 17000		μcd	I _F = 1mA I _F = 10mA
Peak Emission Wavelength	λ _p		632		nm	I _F = 20mA
Spectral Line Half-Width	Δλ		20		nm	I _F = 20mA
Dominant Wavelength	λ _d		624		nm	I _F = 20mA
Forward Voltage Per Segment	V _F		2.1	2.6	V	I _F = 20mA
Reverse Current Per Segment	I _R			100	μA	V _R = 5V
Luminous Intensity Matching Ratio	I _v -m			2 : 1		I _F = 1mA

Note: 1.Luminous Intensity is measured with a light sensor and filter combination that approximates the CIE (Commision Internationale De L'Eclairage) eye-response curve.

2. Reverse voltage is only for IR test. It can not continue to operate at this situation.

TYPICAL ELECTRICAL / OPTICAL CHARACTERISTIC CURVES

(25°C Ambient Temperature Unless Otherwise Noted)

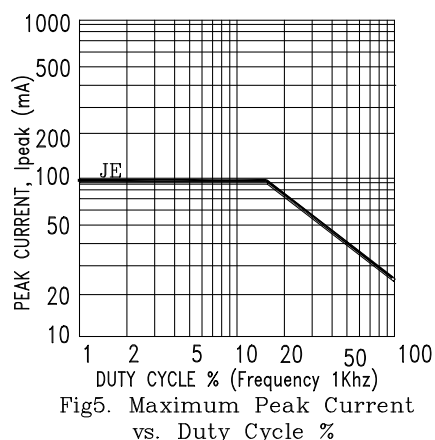
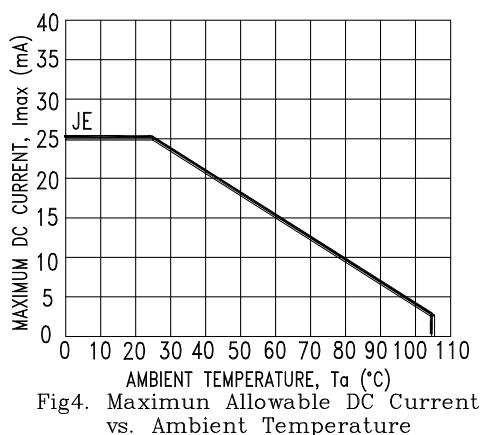
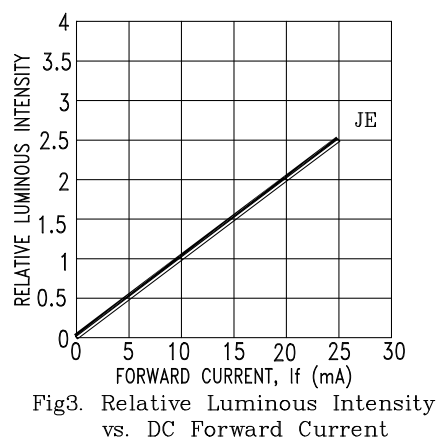
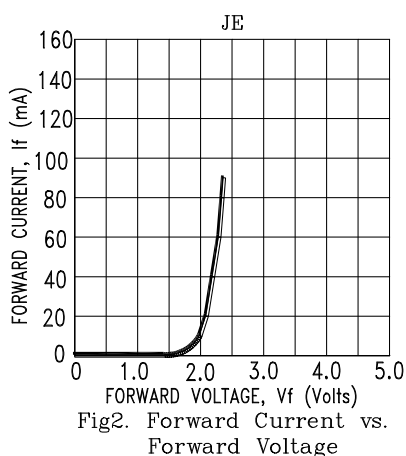
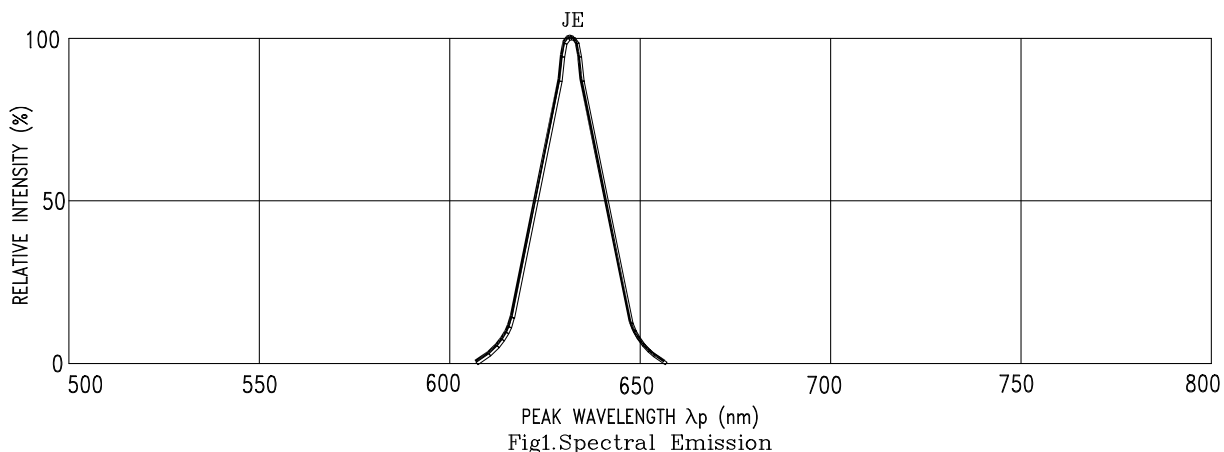

NOTE : JE=AlInGaP RED