



LED Display Product Data Sheet LTC-5836JG

Spec No.: DS30-2003-210

Effective Date: 10/25/2003

Revision: -

LITE-ON DCC

RELEASE

BNS-OD-FC001/A4

FEATURES

- * 0.52 inch (13.2 mm) DIGIT HEIGHT
- * CONTINUOUS UNIFORM SEGMENTS
- * LOW POWER REQUIREMENT
- * EXCELLENT CHARACTERS APPEARANCE
- * HIGH BRIGHTNESS & HIGH CONTRAST
- * WIDE VIEWING ANGLE
- * SOLID STATE RELIABILITY
- * CATEGORIZED FOR LUMINOUS INTENSITY

DESCRIPTION

The LTC-5836JG is a 0.52 inch (13.2 mm) digit height triple LED display. This device uses AS-AllnGaP GREEN LED chips(AllnGaP epi on GaAs substrate).The display has gray face and white segments.

DEVICE

PART NO.	DESCRIPTION
AllnGaP GREEN	Common Anode
LTC-5836JG	R.t Hand Decimal

PACKAGE DIMENSIONS

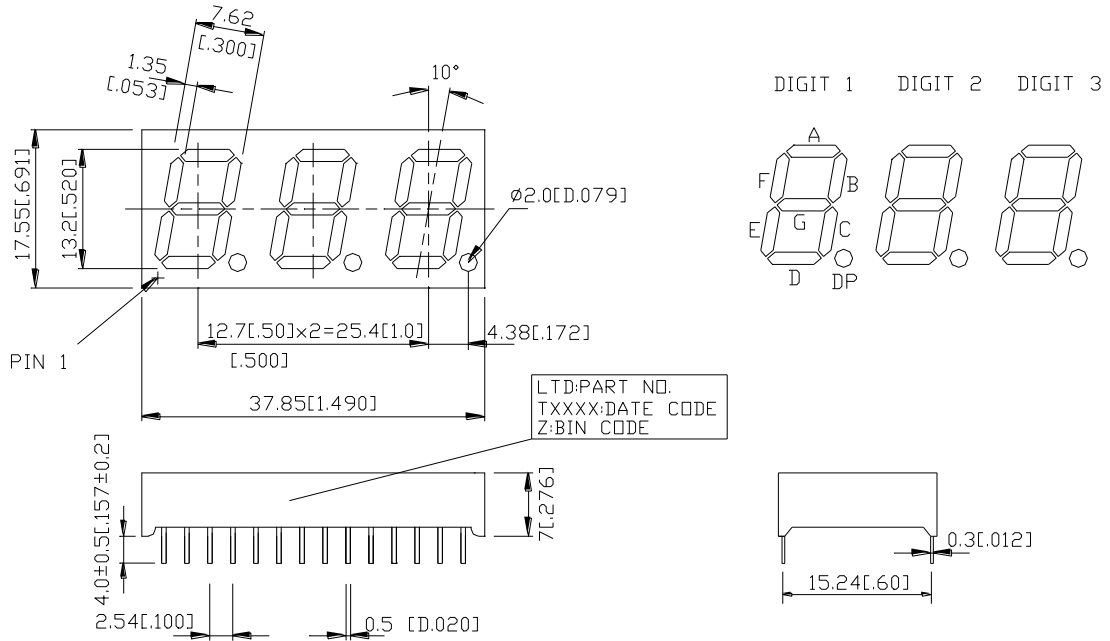

NOTES: All dimensions are in millimeters. Tolerances are ± 0.25 -mm (0.01") unless otherwise noted.

INTERNAL CIRCUIT DIAGRAM

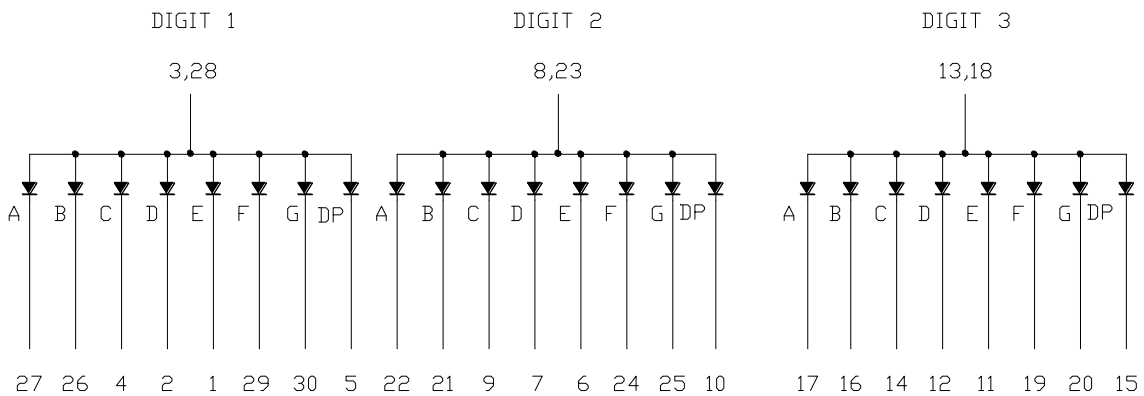

PIN CONNECTION

NO	CONNECTION	NO	CONNECTION
1	CATHODE E (DIGIT 1)	16	CATHODE B (DIGIT 3)
2	CATHODE D (DIGIT 1)	17	CATHODE A (DIGIT 3)
3	COMMON ANODE (DIGIT 1)	18	COMMON ANODE (DIGIT 3)
4	CATHODE C (DIGIT 1)	19	CATHODE F (DIGIT 3)
5	CATHODE D.P. (DIGIT 1)	20	CATHODE G (DIGIT 3)
6	CATHODE E (DIGIT 2)	21	CATHODE B (DIGIT 2)
7	CATHODE D (DIGIT 2)	22	CATHODE A (DIGIT 2)
8	COMMON ANODE (DIGIT 2)	23	COMMON ANODE (DIGIT 2)
9	CATHODE C (DIGIT 2)	24	CATHODE F (DIGIT 2)
10	CATHODE D.P. (DIGIT 2)	25	CATHODE G (DIGIT 2)
11	CATHODE E (DIGIT 3)	26	CATHODE B (DIGIT 1)
12	CATHODE D (DIGIT 3)	27	CATHODE A (DIGIT 1)
13	COMMON ANODE (DIGIT 3)	28	COMMON ANODE (DIGIT 1)
14	CATHODE C (DIGIT 3)	29	CATHODE F (DIGIT 1)
15	CATHODE D.P. (DIGIT 3)	30	CATHODE G (DIGIT 1)

ABSOLUTE MAXIMUM RATING

PARAMETER	MAXIMUM RATING	UNIT
Power Dissipation Per Segment	70	mW
Peak Forward Current Per Segment (Frequency 1Khz, 10% duty cycle)	60*	mA
Continuous Forward Current Per Segment	25	mA
Forward Current Derating from 25 ⁰ C	0.33	mA/ ⁰ C
Reverse Voltage Per Segment	5	V
Operating Temperature Range	-35 ⁰ C to +85 ⁰ C	
Storage Temperature Range	-35 ⁰ C to +85 ⁰ C	
Soldering Conditions : 1/16 inch below seating plane for 3 seconds at 260 ⁰ C		

* see figure 5 to establish pulsed condition

ELECTRICAL / OPTICAL CHARACTERISTICS

PARAMETER	SYMBOL	MIN.	TYP.	MAX.	UNIT	TEST CONDITION
Average Luminous Intensity Per Segment	I _v	200	577 6346		μcd	I _F =1mA I _F =10mA
Peak Emission Wavelength	λ _p		571		nm	I _F =20mA
Spectral Line Half-Width	Δλ		15		nm	I _F =20mA
Dominant Wavelength	λ _d		572		nm	I _F =20mA
Forward Voltage Per Segment	V _F		2.1	2.6	V	I _F =20mA
Reverse Current Per Segment	I _R			100	μA	V _R =5V
Luminous Intensity Matching Ratio	I _v -m			2:1		I _F =1mA

Note: Luminous intensity is measured with a light sensor and filter combination that approximates the CIE (commision internationale DE L'clariage) eye-response curve.

TYPICAL ELECTRICAL / OPTICAL CHARACTERISTIC CURVES

(25°C Ambient Temperature Unless Otherwise Noted)

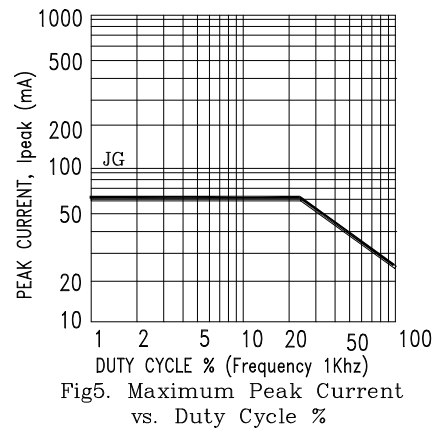
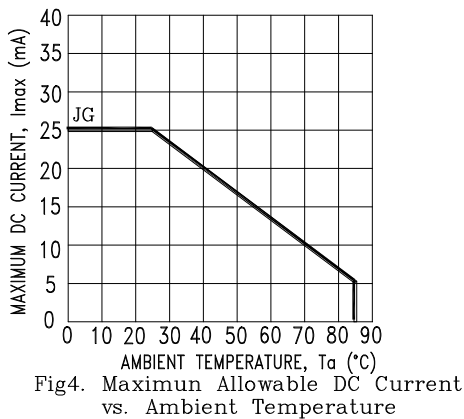
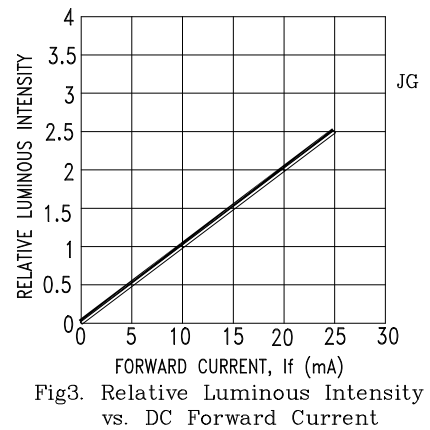
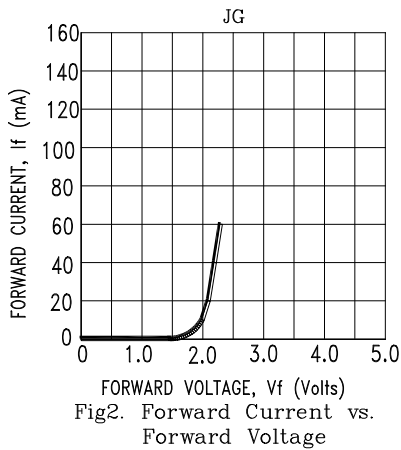
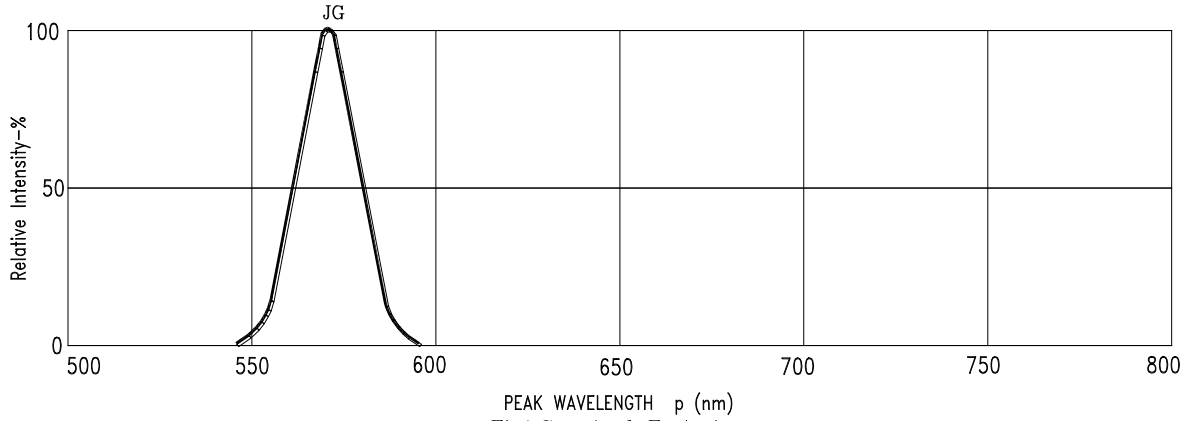

NOTE : JG=AlInGaP Green