



# LED Display Product Data Sheet LTD-5621AG-14

Spec No.: DS30-2004-155

Effective Date: 08/17/2004

Revision: -

**LITE-ON DCC**

**RELEASE**

BNS-OD-FC001/A4

**FEATURES**

- \* 0.56 inch (14.22 mm) DIGIT HEIGHT
- \* CONTINUOUS UNIFORM SEGMENTS
- \* LOW POWER REQUIREMENT
- \* EXCELLENT CHARACTERS APPEARANCE
- \* HIGH BRIGHTNESS & HIGH CONTRAST
- \* WIDE VIEWING ANGLE
- \* SOLID STATE RELIABILITY
- \* CATEGORIZED FOR LUMINOUS INTENSITY
- \* **LEAD-FREE PACKAGE**

**DESCRIPTION**

The LTD-5621AG-14 is a 0.56 inch (14.22 mm) digit height dual digit seven-segment display. The device uses GREEN LED chips (GaP epi on GaP substrate). The display has gray face and green segments.

**DEVICE**

PART NO.	DESCRIPTION
GREEN	Common anode
LTD-5621AG-14	Rt. Hand decimal

**PACKAGE DIMENSIONS**

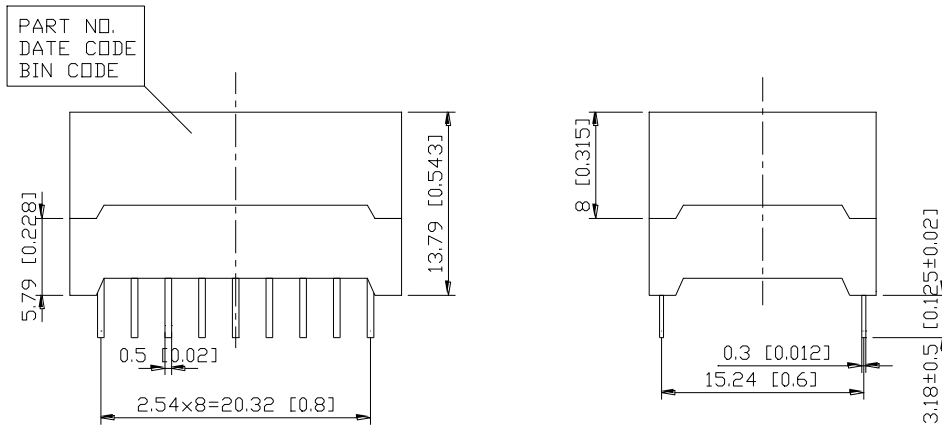
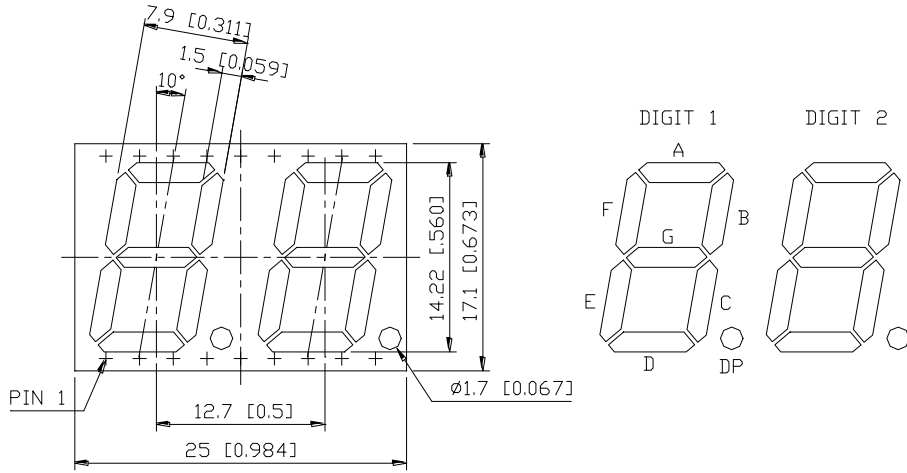

NOTES: All dimensions are in millimeters. Tolerances are ± 0.25 mm unless otherwise noted.

**INTERNAL CIRCUIT DIAGRAM**

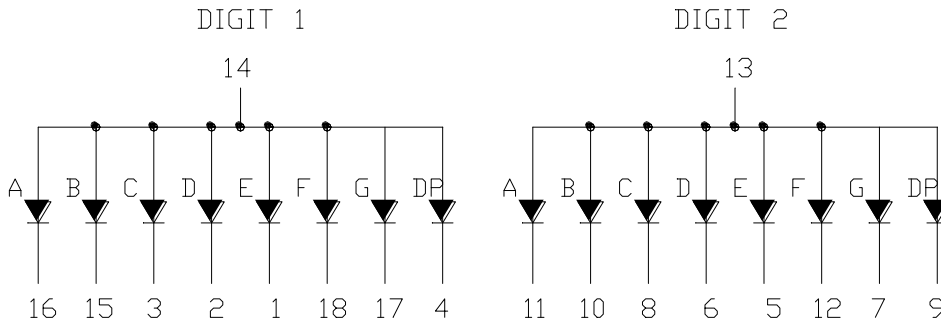

**PIN CONNECTION**

<b>No.</b>	<b>CONNECTION</b>
1	CATHODE E (DIGIT 1)
2	CATHODE D (DIGIT 1)
3	CATHODE C (DIGIT 1)
4	CATHODE DP (DIGIT 1)
5	CATHODE E (DIGIT 2)
6	CATHODE D (DIGIT 2)
7	CATHODE G (DIGIT 2)
8	CATHODE C (DIGIT 2)
9	CATHODE DP (DIGIT 2)
10	CATHODE B (DIGIT 2)
11	CATHODE A (DIGIT 2)
12	CATHODE F (DIGIT 2)
13	COMMON ANODE DIGIT 2
14	COMMON ANODE DIGIT 1
15	CATHODE B (DIGIT 1)
16	CATHODE A (DIGIT 1)
17	CATHODE G (DIGIT 1)
18	CATHODE F (DIGIT 1)

**ABSOLUTE MAXIMUM RATING**

PARAMETER	MAXIMUM RATING	UNIT
Power Dissipation Per Chip	75	mW
Peak Forward Current Per Chip ( Frequency 1Khz, 10% duty cycle)	100*	mA
Continuous Forward Current Per Chip	25	mA
Forward Current Derating from 25 <sup>0</sup> C	0.33	mA/ <sup>0</sup> C
Reverse Voltage Per Chip	5	V
Operating Temperature Range	-35 <sup>0</sup> C to +85 <sup>0</sup> C	
Storage Temperature Range	-35 <sup>0</sup> C to +85 <sup>0</sup> C	
Soldering Conditions : 1/16 inch below seating plane for 3 seconds at 260 <sup>0</sup> C		

\* see figure 5 to establish pulsed condition

**TRICAL / OPTICAL CHARACTERISTICS AT T<sub>A</sub>=25<sup>0</sup>C**

PARAMETER	SYMBOL	MIN.	TYP.	MAX.	UNIT	TEST CONDITION
Average Luminous Intensity	I <sub>v</sub>	800	2400		μcd	I <sub>F</sub> =10mA
Peak Emission Wavelength	λ <sub>p</sub>		565		nm	I <sub>F</sub> =20mA
Spectral Line Half-Width	Δλ		30		nm	I <sub>F</sub> =20mA
Dominant Wavelength	λ <sub>d</sub>		569		nm	I <sub>F</sub> =20mA
Forward Voltage Per Chip	V <sub>F</sub>		2.1	2.6	V	I <sub>F</sub> =20mA
Reverse Current Per Chip	I <sub>R</sub>			100	μA	V <sub>R</sub> =5V
Luminous Intensity Matching Ratio	I <sub>v</sub> -m			2:1		I <sub>F</sub> =10mA

Note: Luminous intensity is measured with a light sensor and filter combination that approximates the CIE (Commision Internationale De L'Eclairage) eye-response curve.

**TYPICAL ELECTRICAL / OPTICAL CHARACTERISTIC CURVES**

(25°C Ambient Temperature Unless Otherwise Noted)

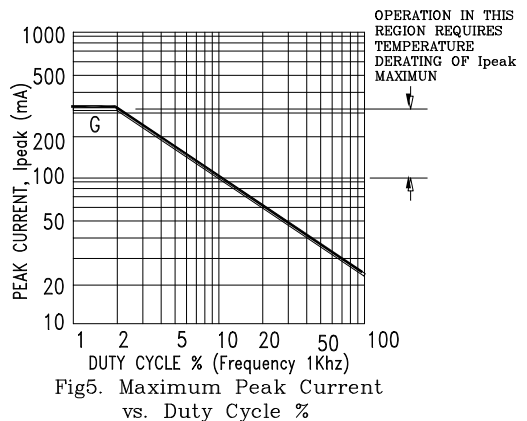
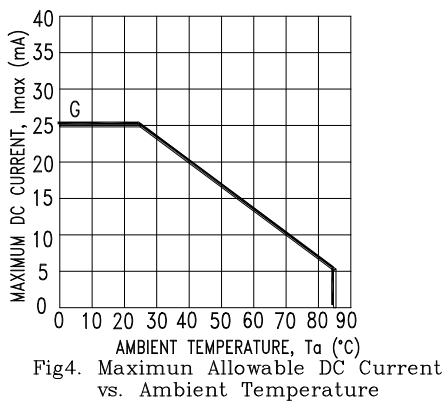
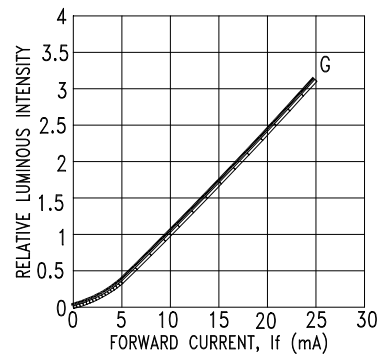
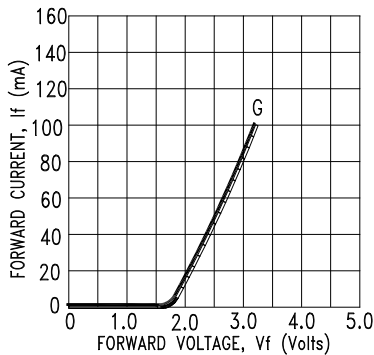
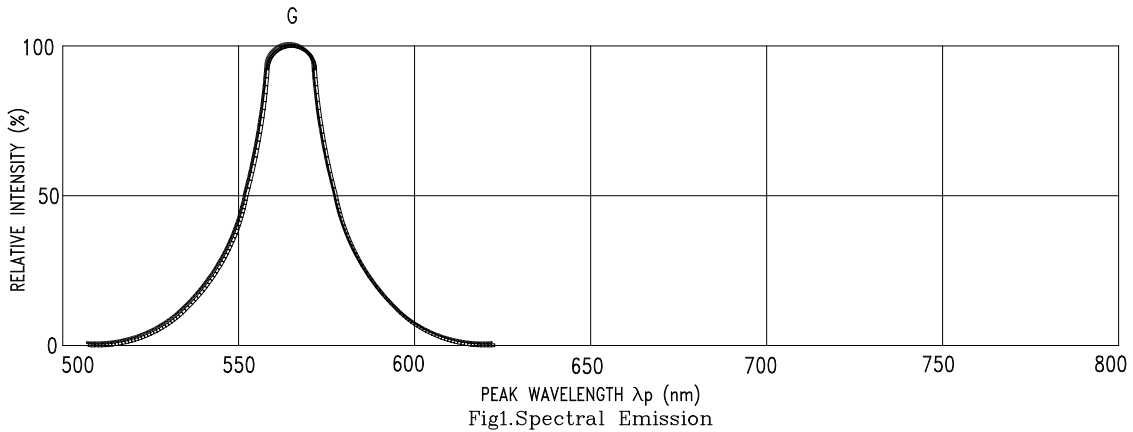

NOTE: G=GREEN.