



LED Display Product Data Sheet LTD-6710KD-08J

Spec No.: DS30-2005-173

Effective Date: 09/08/2005

Revision: -

LITE-ON DCC

RELEASE

BNS-OD-FC001/A4

FEATURES

- * 0.56 inch (14.22 mm) DIGIT HEIGHT
- * CONTINUOUS UNIFORM SEGMENTS
- * LOW POWER REQUIREMENT
- * EXCELLENT CHARACTERS APPEARANCE
- * HIGH BRIGHTNESS & HIGH CONTRAST
- * WIDE VIEWING ANGLE
- * SOLID STATE RELIABILITY
- * CATEGORIZED FOR LUMINOUS INTENSITY
- * **LEAD FREE PACKAGE**

DESCRIPTION

The LTD-6710KD-08J is a 0.56 inch (14.22 mm) digit height dual digit low current seven-segment display. This device uses AlInGaP Hyper Red LED chips (AlInGaP epi on GaAs substrate). The display has a black face and red segments.

DEVICE

PART NO.	DESCRIPTION
AlInGaP Hyper Red	Common Anode
LTD-6710KD-08J	RT.HAND DECIMAL

PACKAGE DIMENSIONS

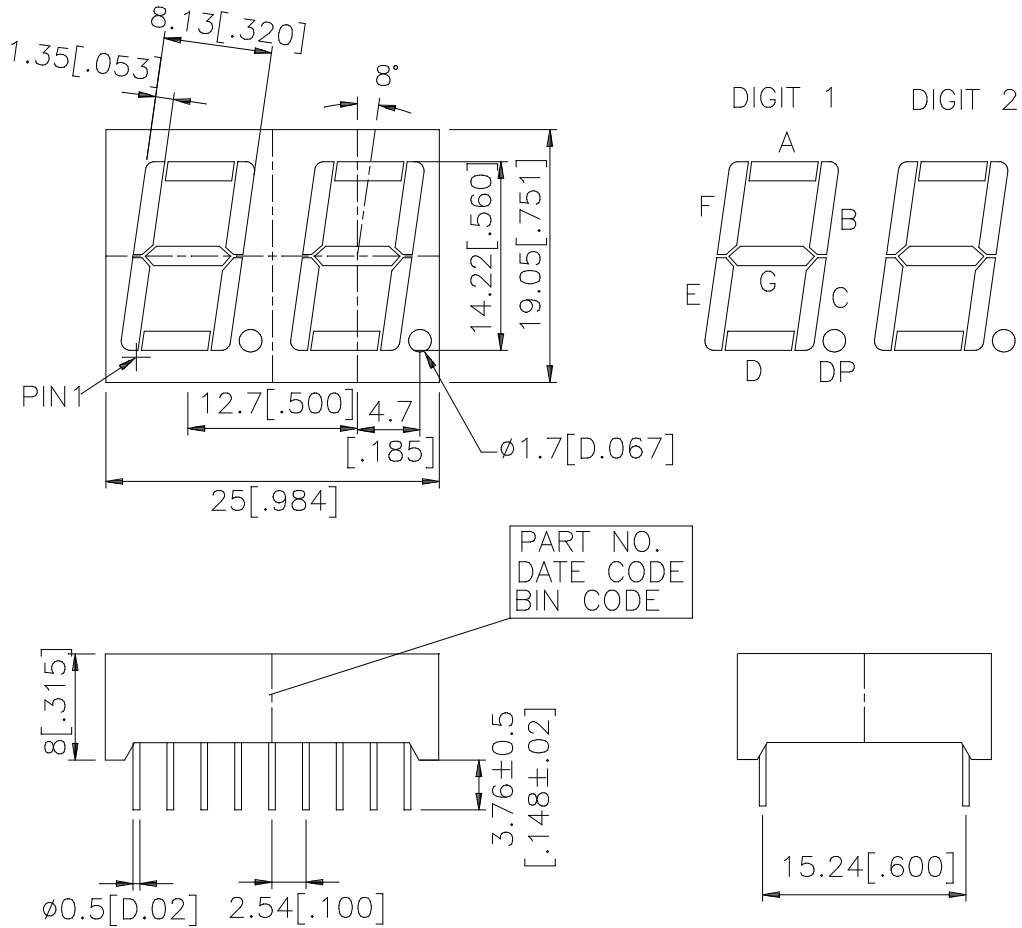

NOTES: All dimensions are in millimeters. Tolerances are ± 0.25 mm (0.01") unless otherwise noted.

INTERNAL CIRCUIT DIAGRAM

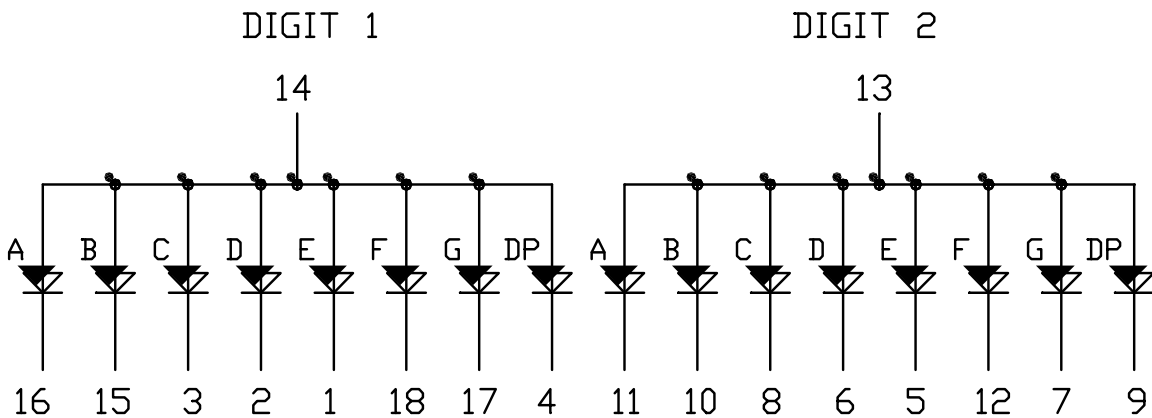

PIN CONNECTION

No.	CONNECTION
1	CATHODE E (DIGIT 1)
2	CATHODE D (DIGIT 1)
3	CATHODE C (DIGIT 1)
4	CATHODE DP (DIGIT 1)
5	CATHODE E (DIGIT 2)
6	CATHODE D (DIGIT 2)
7	CATHODE G (DIGIT 2)
8	CATHODE C (DIGIT 2)
9	CATHODE DP (DIGIT 2)
10	CATHODE B (DIGIT 2)
11	CATHODE A (DIGIT 2)
12	CATHODE F (DIGIT 2)
13	COMMON ANODE (DIGIT 2)
14	COMMON ANODE (DIGIT 1)
15	CATHODE B (DIGIT 1)
16	CATHODE A (DIGIT 1)
17	CATHODE G (DIGIT 1)
18	CATHODE F (DIGIT 1)

ABSOLUTE MAXIMUM RATING

PARAMETER	MAXIMUM RATING	UNIT
Power Dissipation Per Segment	70	mW
Peak Forward Current Per Segment (Frequency 1Khz, 10% duty cycle)	90	mA
Continuous Forward Current Per Segment	25	mA
Forward Current Derating from 25 ⁰ C	0.28	mA/°C
Reverse Voltage Per Segment	5	V
Operating Temperature Range	-35°C to +105°C	
Storage Temperature Range	-35°C to +105°C	
Soldering Conditions : 1/16 inch below seating plane for 3 seconds at 260 ⁰ C		

ELECTRICAL / OPTICAL CHARACTERISTICS AT Ta=25°C

PARAMETER	SYMBOL	MIN.	TYP.	MAX.	UNIT	TEST CONDITION
Average Luminous Intensity	I _v	500	1250		μcd	I _F =1mA
			16250			I _F =10mA
Peak Emission Wavelength	λ _p		650		nm	I _F =20mA
Spectral Line Half-Width	Δλ		20		nm	I _F =20mA
Dominant Wavelength	λ _d		639		nm	I _F =20mA
Forward Voltage Per Chip			2.1	2.6		I _F =20mA
Reverse Current Per Segment	I _R			100	μA	V _R =5V
Luminous Intensity Matching Ratio (Similar Light Area)	I _{v-m}			2:1		I _F =1mA

Note: Luminous intensity is measured with a light sensor and filter combination that approximates the CIE (Commision Internationale De L'Eclairage) eye-response curve.

TYPICAL ELECTRICAL / OPTICAL CHARACTERISTIC CURVES

(25°C Ambient Temperature Unless Otherwise Noted)

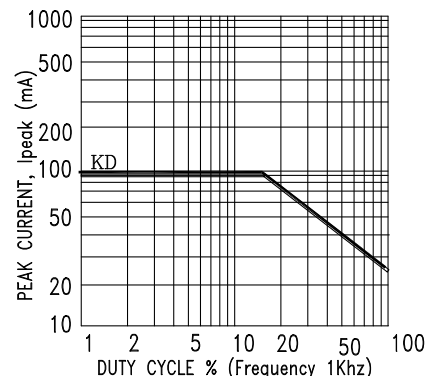
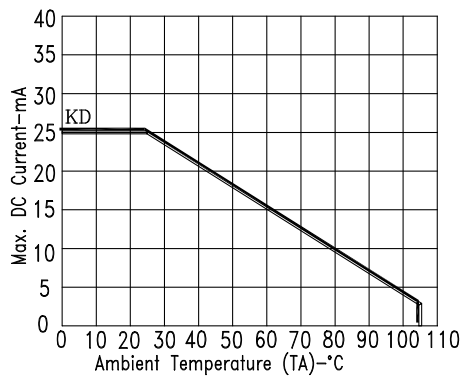
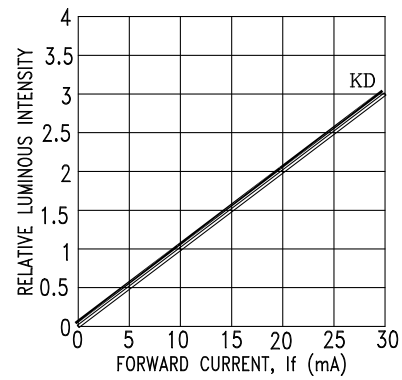
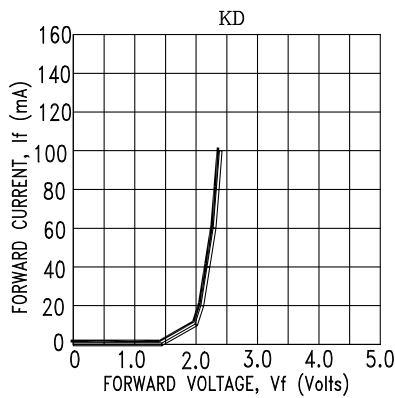
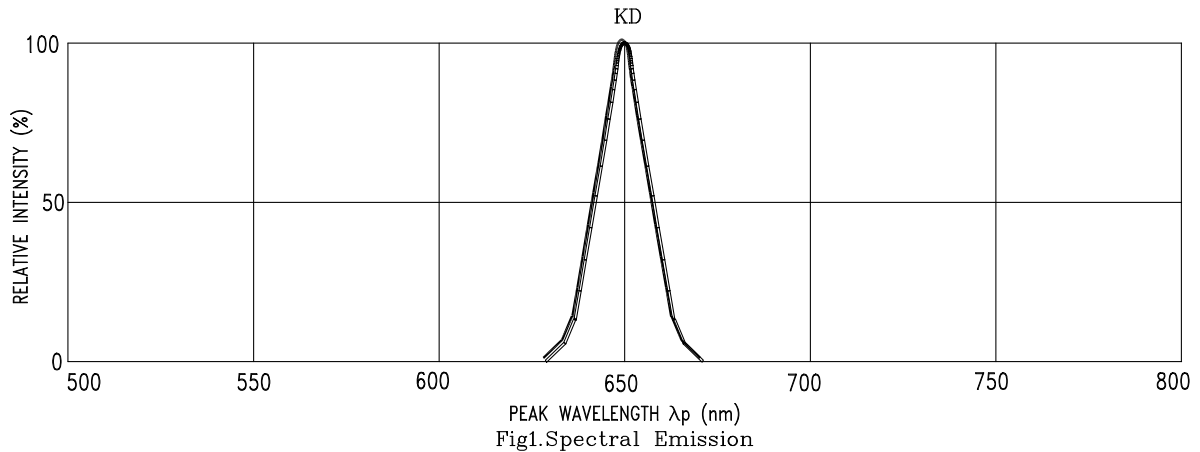

NOTE : KD=AlInGaP HYPER RED