



# LED Display Product Data Sheet LTS-4301KD

Spec No.: DS30-2005-235

Effective Date: 01/31/2006

Revision: -

**LITE-ON DCC**

**RELEASE**

BNS-OD-FC001/A4

**FEATURES**

- \* 0.4 inch (10 mm ) DIGIT HEIGHT
- \* EXCELLENT SEGMENT UNIFORMITY
- \* LOW POWER REQUIREMENT
- \* HIGH BRIGHTNESS AND HIGH CONTRAST
- \* WIDE VIEWING ANGLE
- \* SOLID STATE RELIABILITY
- \* BINNED FOR LUMINOUS INTENSITY
- \* **LEAD-FREE PACKAGE**

**DESCRIPTION**

The LTS-4301KD is a 0.4 inch (10 mm) digit height single-digit display. This device uses AlInGaP HYPER RED chips (AlInGaP epi on GaAs substrate). The display has gray face and white segments.

**DEVICE**

<b>PART NO.</b>	<b>DESCRIPTION</b>
AllnGaP HYPER RED	Common Cathode
LTS-4301KD	Rt. Hand Decimal

## PACKAGE DIMENSIONS

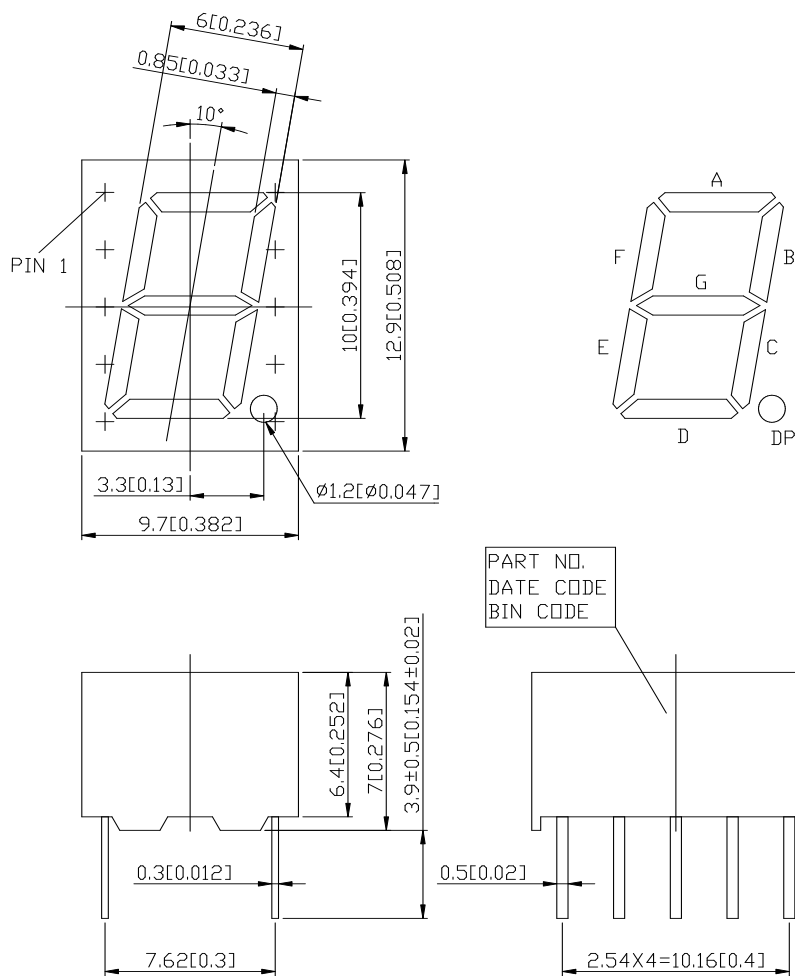

NOTES: 1. All dimensions are in millimeters. Tolerances are  $\pm 0.25$ mm (0.01") unless otherwise noted.  
 2. Pin tip's shift tolerance is  $\pm 0.4$  mm.

## INTERNAL CIRCUIT DIAGRAM

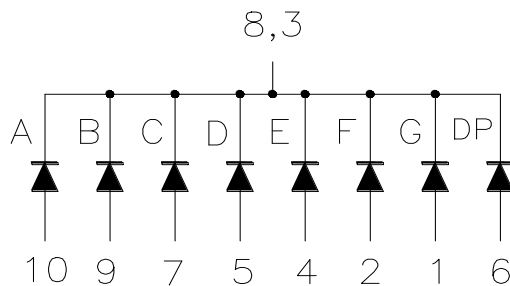

**PIN CONNECTION**

<b>No</b>	<b>CONNECTION</b>
1	ANODE G
2	ANODE F
3	COMMON CATHODE
4	ANODE E
5	ANODE D
6	ANODE D.P.
7	ANODE C
8	COMMON CATHODE
9	ANODE B
10	ANODE A

**ABSOLUTE MAXIMUM RATING**

PARAMETER	MAXIMUM RATING	UNIT
Power Dissipation Per Segment	70	mW
Peak Forward Current Per Segment ( Frequency 1Khz, 10% duty cycle)	90	mA
Continuous Forward Current Per Segment	25	mA
Forward Current Derating from 25 <sup>0</sup> C	0.28	mA/ <sup>0</sup> C
Reverse Voltage Per Segment	5	V
Operating Temperature Range	-35 <sup>0</sup> C to +105 <sup>0</sup> C	
Storage Temperature Range	-35 <sup>0</sup> C to +105 <sup>0</sup> C	
Soldering Conditions : 1/16 inch below seating plane for 3 seconds at 260 <sup>0</sup> C, or temperature of unit (during assembly) not over max. temperature rating above		

**ELECTRICAL / OPTICAL CHARACTERISTICS AT Ta=25<sup>0</sup>C**

PARAMETER	SYMBOL	MIN	TYP	MAX	UNIT	TEST CONDITION
Average Luminous Intensity Per Segment	I <sub>v</sub>	200	650		μcd	I <sub>F</sub> = 1mA
			9750			I <sub>F</sub> = 10mA
Peak Emission Wavelength	λ <sub>p</sub>		650		nm	I <sub>F</sub> = 20mA
Spectral Line Half-Width	Δλ		20		nm	I <sub>F</sub> = 20mA
Dominant Wavelength	λ <sub>d</sub>		639		nm	I <sub>F</sub> = 20mA
Forward Voltage Per Segment	V <sub>F</sub>		2.1	2.6	V	I <sub>F</sub> = 20mA
Reverse Current Per Segment	I <sub>R</sub>			100	μA	V <sub>R</sub> = 5V
Luminous Intensity Matching Ratio (Similar Light Area)	I <sub>v-m</sub>			2 : 1		I <sub>F</sub> = 1mA

Note: Luminous Intensity is measured with a light sensor and filter combination that approximates the CIE (Commision Internationale De L'Eclairage) eye-response curve.

### TYPICAL ELECTRICAL / OPTICAL CHARACTERISTIC CURVES

(25°C Ambient Temperature Unless Otherwise Noted)

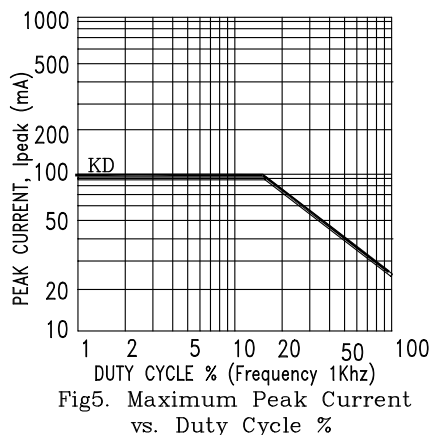
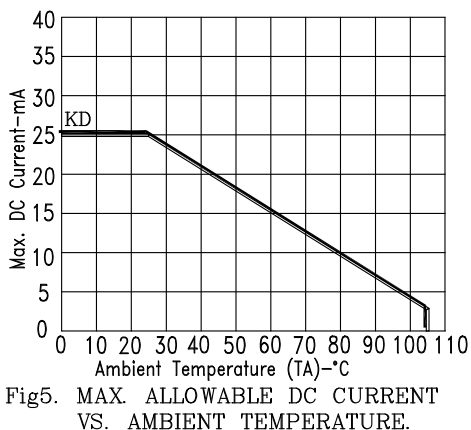
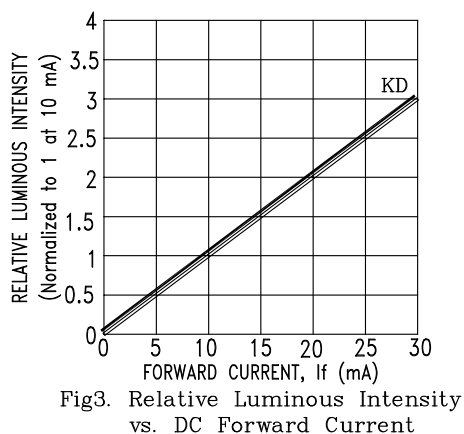
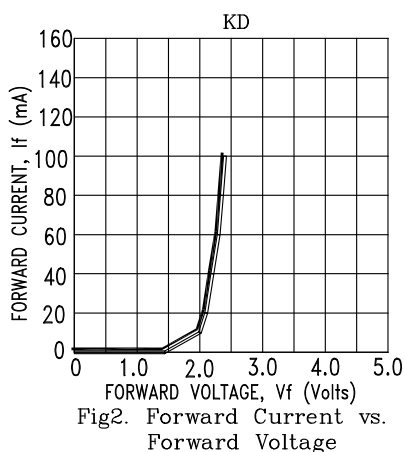
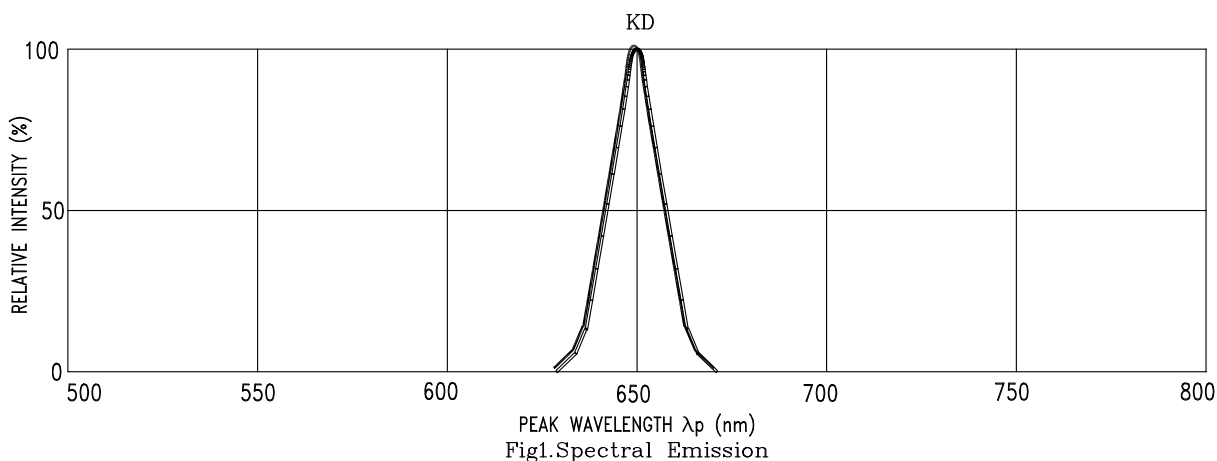

NOTE : KD=AlInGaP HYPER RED