



LED Display Product Data Sheet LTS-5703AJF

Spec No.: DS30-2006-048

Effective Date: 05/03/2006

Revision: -

LITE-ON DCC

RELEASE

BNS-OD-FC001/A4

FEATURES

- * 0.56 inch (14.22 mm) DIGIT HEIGHT.
- * CONTINUOUS UNIFORM SEGMENTS.
- * LOW POWER REQUIREMENT.
- * EXCELLENT CHARACTERS APPEARANCE.
- * HIGH BRIGHTNESS & HIGH CONTRAST.
- * WIDE VIEWING ANGLE.
- * SOLID STATE RELIABILITY.
- * CATEGORIZED FOR LUMINOUS INTENSITY.
- * **LEAD-FREE PACKAGE (ACCORDING TO ROHS)**

DESCRIPTION

The LTS-5703AJF is a 0.56 inch (14.22 mm) height digit display. The device utilizes AS-AllnGaP Yellow Orange LED chips (AllnGaP epi on GaAs substrate), and have light gray face and white segments.

DEVICE

| PART NO. | DESCRIPTION |
|-----------------------|--------------------|
| AllnGaP Yellow Orange | Common Cathode |
| LTS-5703AJF | Rt. Hand Decimal |

PACKAGE DIMENSIONS

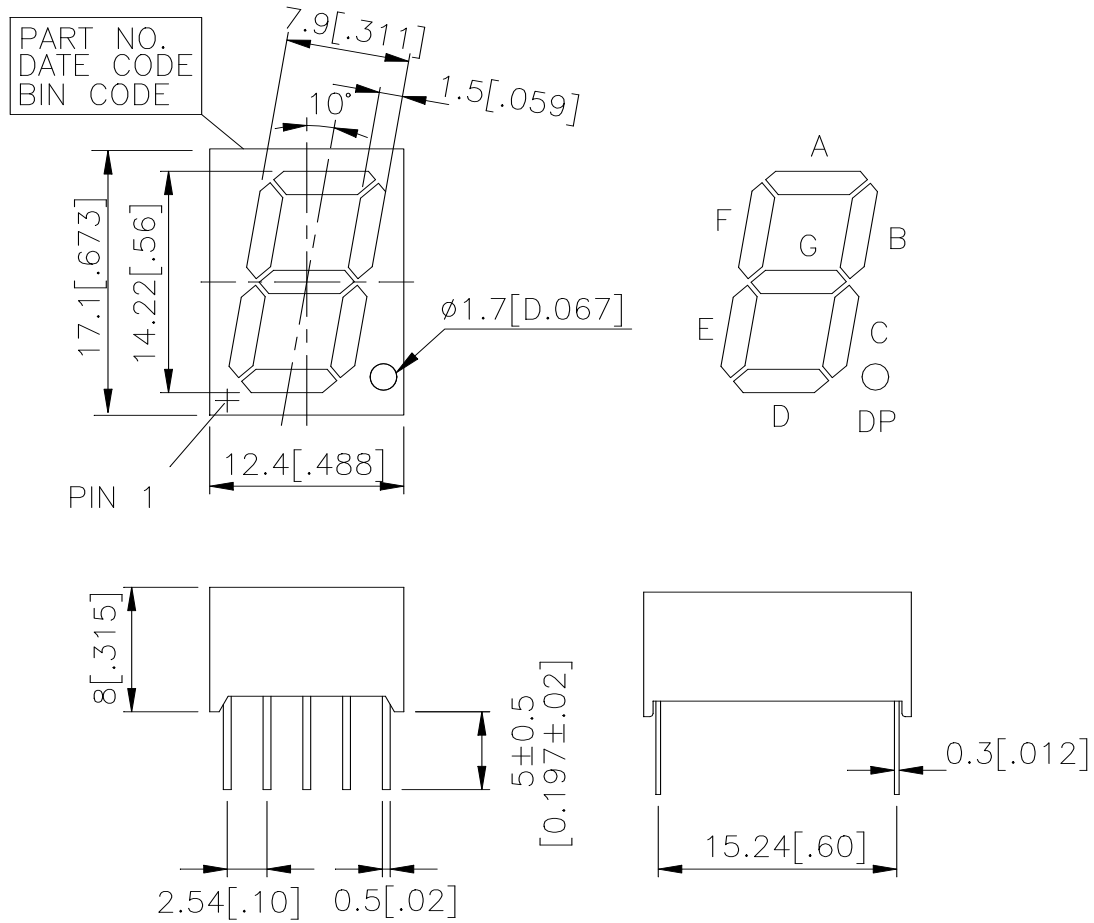

- NOTES: 1. All dimensions are in millimeters. Tolerances are ± 0.25-mm (0.01“) unless otherwise noted.
 2. Pin tip's shift tolerance is +/- 0.4 mm.

INTERNAL CIRCUIT DIAGRAM

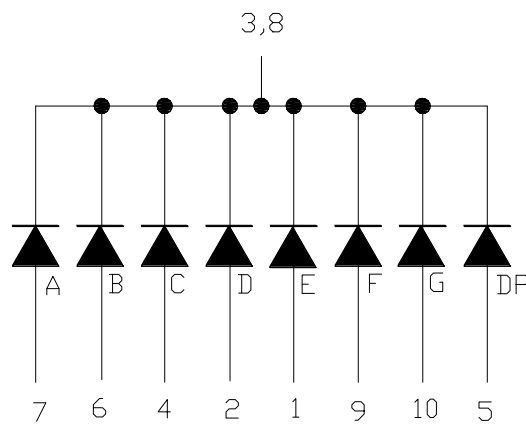

PIN CONNECTION

| No. | CONNECTION |
|------------|-------------------|
| 1 | ANODE E |
| 2 | ANODE D |
| 3 | COMMON CATHODE |
| 4 | ANODE C |
| 5 | ANODE D.P. |
| 6 | ANODE B |
| 7 | ANODE A |
| 8 | COMMON CATHODE |
| 9 | ANODE F |
| 10 | ANODE G |

ABSOLUTE MAXIMUM RATING AT Ta=25°C

| PARAMETER | MAXIMUM RATING | UNIT |
|--|-----------------|-------|
| Power Dissipation Per Segment | 70 | mW |
| Peak Forward Current Per Segment (1/10 Duty Cycle, 0.1ms Pulse Width) | 60 | mA |
| Continuous Forward Current Per Segment | 25 | mA |
| Derating Linear From 25°C Per Segment | 0.33 | mA/°C |
| Reverse Voltage Per Segment | 5 | V |
| Operating Temperature Range | -35°C to +105°C | |
| Storage Temperature Range | -35°C to +105°C | |
| Solder Temperature 1/16 inch Below Seating Plane for 3 Seconds at 260°C., or temperature of unit (during assembly) not over max. temperature rating above | | |

ELECTRICAL / OPTICAL CHARACTERISTICS AT Ta=25°C

| PARAMETER | SYMBOL | MIN. | TYP. | MAX. | UNIT | TEST CONDITION |
|---|------------------|------|------|------|------|----------------------|
| Average Luminous Intensity | I _v | 800 | 1667 | | μcd | I _F =1mA |
| Peak Emission Wavelength | λ _p | | 611 | | nm | I _F =20mA |
| Spectral Line Half-Width | Δλ | | 17 | | nm | I _F =20mA |
| Dominant Wavelength | λ _d | | 605 | | nm | I _F =20mA |
| Forward Voltage Per Segment | V _F | | 2.05 | 2.6 | V | I _F =20mA |
| Reverse Current Per Segment | I _R | | | 100 | μA | V _R =5V |
| Luminous Intensity Matching Ratio (Similar Light Area) | I _{v-m} | | | 2:1 | | I _F =1mA |

Note: Luminous intensity is measured with a light sensor and filter combination that approximates the CIE (Commision Internationale De L'Eclariage) eye-response curve.

TYPICAL ELECTRICAL / OPTICAL CHARACTERISTIC CURVES

(25°C Ambient Temperature Unless Otherwise Noted)

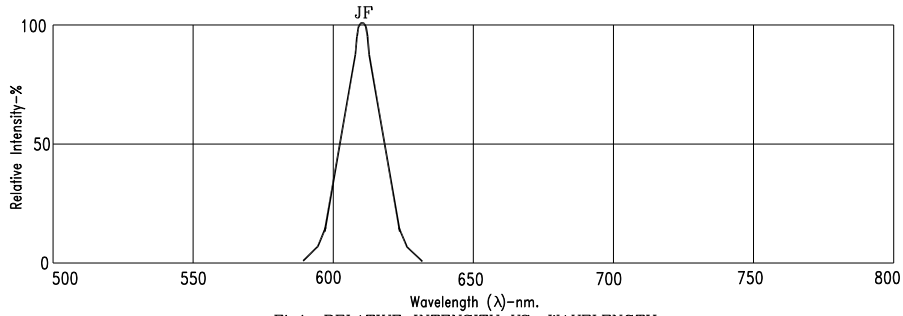

Fig1. RELATIVE INTENSITY VS. WAVELENGTH

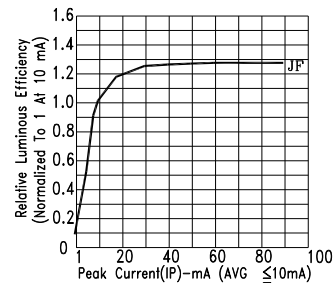

Fig2. RELATIVE LUMINOUS EFFICIENCY (LUMINOUS INTENSITY PER UNIT CURRENT) VS. PEAK CURRENT

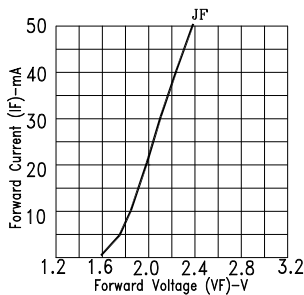

Fig3. FORWARD CURRENT VS. FORWARD VOLTAGE

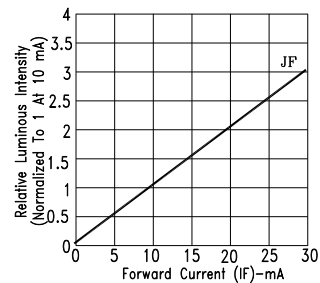

Fig4. RELATIVE LUMINOUS INTENSITY VS. FORWARD CURRENT

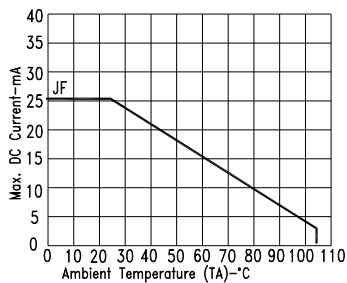

Fig5. MAX. ALLOWABLE DC CURRENT VS. AMBIENT TEMPERATURE.

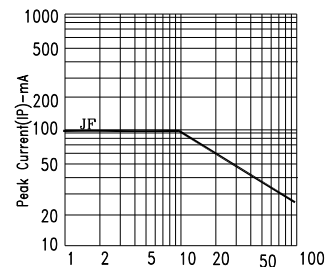

Fig6. MAX. PEAK CURRENT VS. DUTY CYCLE % (REFRESH RATE 1KHz)

NOTE : JF=AlInGaP YELLOW ORANGE