



LED Display Product Data Sheet LTP-3784KS

Spec No.: DS30-2007-0026

Effective Date: 02/07/2007

Revision: -

LITE-ON DCC

RELEASE

BNS-OD-FC001/A4

LED DISPLAY

LTP-3784KS **DATA SHEET**

<u>Rev</u>	<u>Description</u>	<u>By</u>
-	Original Spec	<u>PHANOMKRON J.</u>

S P E C . N O . : DS30-2007-0026

D A T E : JAN/26/'07

R E V . N O . : -

P A G E N O . : 0 O F 5

FEATURES

- * 0.54 INCH (13.8 mm) DIGIT HEIGHT.
- * CONTINUOUS UNIFORM SEGMENTS
- * LOW POWER REQUIREMENT.
- * EXCELLENT CHARACTERS APPEARANCE.
- * HIGH BRIGHTNESS & HIGH CONTRAST.
- * WIDE VIEWING ANGLE.
- * SOLID STATE RELIABILITY.
- * CATEGORIZED FOR LUMINOUS INTENSITY.
- * **LEAD-FREE PACKAGE (ACCORDING TO ROHS)**

DESCRIPTION

The LTP-3784KS is a 0.54 inch (13.8 mm) digit height dual digit 14-segment alphanumeric display. This device utilizes AlInGaP Yellow LED chips, which are made from AlInGaP on a non-transparent GaAs substrate, and has a gray face and white segments.

DEVICE

PART NO.	DESCRIPTION
AllInGaP Yellow	Dual Common Cathode
LTP-3784KS	Rt. Hand Decimal

PACKAGE DIMENSIONS

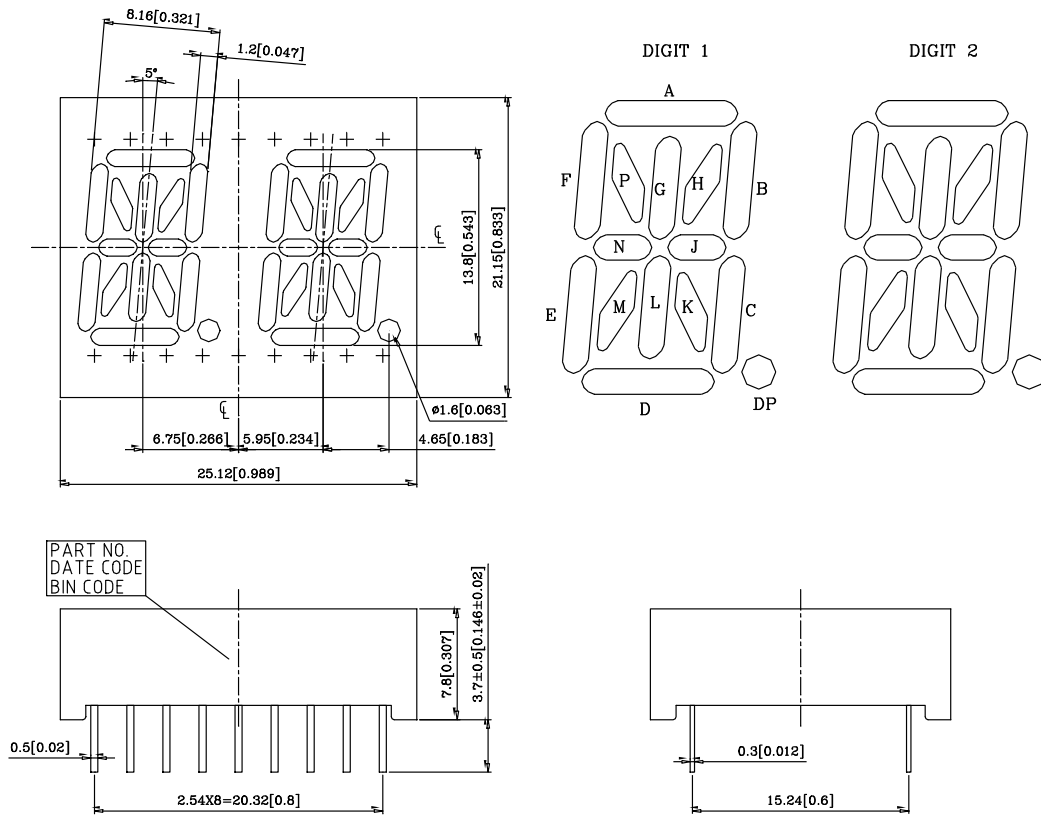

- NOTES: 1. All dimensions are in millimeters. Tolerances are ± 0.25 mm unless otherwise note.
 2. Pin tip's shift tolerance is ± 0.4 mm.

INTERNAL CIRCUIT DIAGRAM

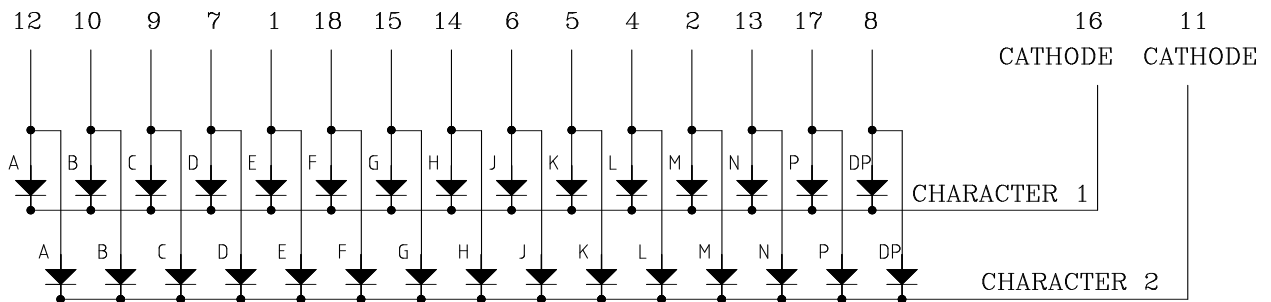

PIN CONNECTION

No.	CONNECTION
1	ANODE E
2	ANODE M
3	NO CONNECTION
4	ANODE L
5	ANODE K
6	ANODE J
7	ANODE D
8	ANODE D.P.
9	ANODE C
10	ANODE B
11	COMMON CATHODE , CHARACTER 2
12	ANODE A
13	ANODE N
14	ANODE H
15	ANODE G
16	COMMON CATHODE , CHARACTER 1
17	ANODE P
18	ANODE F

ABSOLUTE MAXIMUM RATING AT T_A=25°C

PARAMETER	MAXIMUM RATING	UNIT
Power Dissipation Per Segment	70	mW
Peak Forward Current Per Segment (1/10 Duty Cycle, 1.0ms Pulse Width)	60	mA
Continuous Forward Current Per Segment	25	mA
Derating Linear From 25°C Per Segment	0.33	mA/°C
Reverse Voltage Per Segment	5	V
Operating Temperature Range	-35°C to +105°C	
Storage Temperature Range	-35°C to +105°C	

Soldering Conditions: 1/16 inch below seating plane for 3 seconds at 260°C
or of temperature unit (during assembly) not over max. temperature rating above.

ELECTRICAL / OPTICAL CHARACTERISTICS AT T_A=25°C

PARAMETER	SYMBOL	MIN.	TYP.	MAX.	UNIT	TEST CONDITION
Average Luminous Intensity	I _v		18200		μcd	I _F =10mA
Peak Emission Wavelength	λ _p		588		nm	I _F =20mA
Spectral Line Half-Width	Δλ		15		nm	I _F =20mA
Dominant Wavelength	λ _d		587		nm	I _F =20mA
Forward Voltage Per Segment	V _F		2.05	2.6	V	I _F =20mA
Reverse Current Per Segment	I _R			100	μA	V _R =5V
Luminous Intensity Matching Ratio (Similar Light Area)	I _v -m			2:1		I _F =10mA

Note: Luminous intensity is measured with a light sensor and filter combination that approximates the CIE (Commission Internationale De L'Eclairage) eye-response curve.

TYPICAL ELECTRICAL / OPTICAL CHARACTERISTIC CURVES

(25°C Ambient Temperature Unless Otherwise Noted)

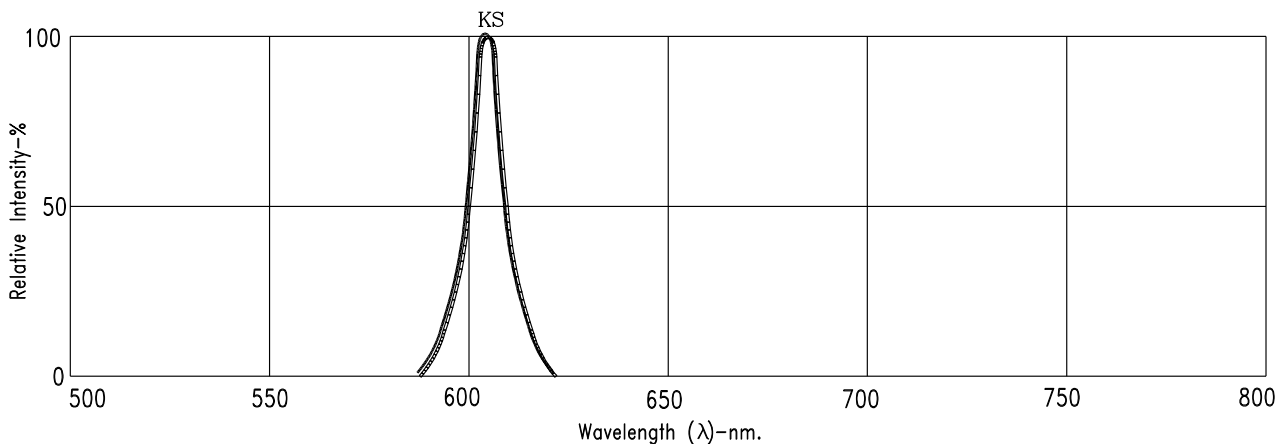

Fig1. RELATIVE INTENSITY VS. WAVELENGTH

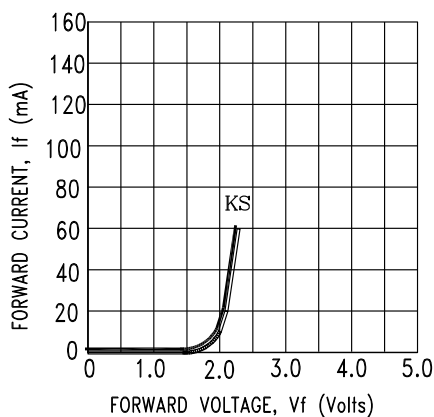

Fig2. Forward Current vs. Forward Voltage

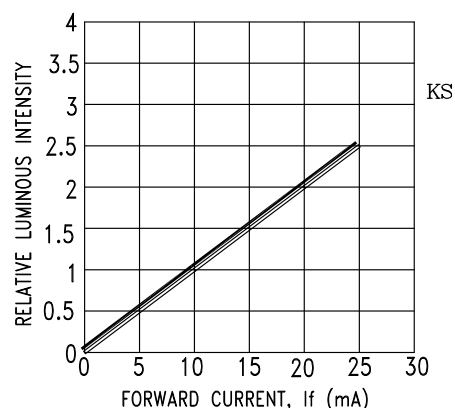

Fig3. Relative Luminous Intensity vs. DC Forward Current

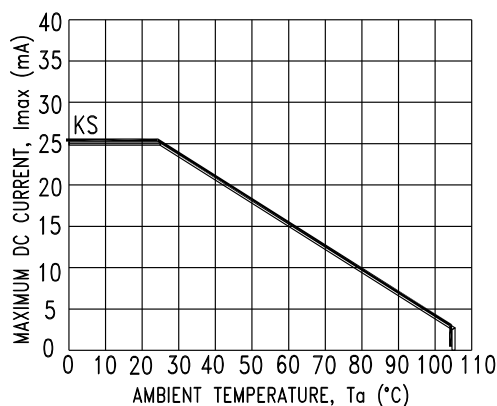

Fig4. Maximum Allowable DC Current vs. Ambient Temperature

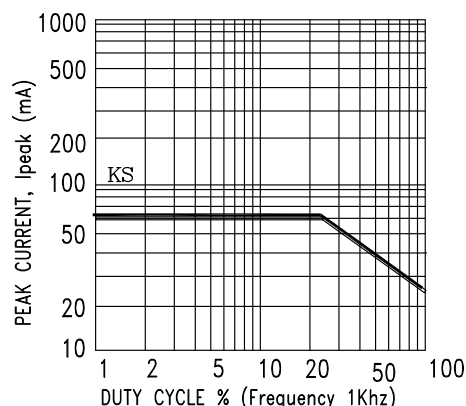

Fig5. Maximum Peak Current vs. Duty Cycle %

NOTE : KS=AlInGaP YEELOW