



LED Display Product Data Sheet LTS-4802CB

Spec No.: DS30-2007-0080

Effective Date: 05/13/2007

Revision: -

LITE-ON DCC

RELEASE

BNS-OD-FC001/A4

FEATURES

- * 0.4 inch (10.0 mm) DIGIT HEIGHT
- * CONTINUOUS UNIFORM SEGMENTS
- * LOW POWER REQUIREMENT
- * EXCELLENT CHARACTERS APPEARANCE
- * HIGH BRIGHTNESS & HIGH CONTRAST
- * WIDE VIEWING ANGLE
- * SOLID STATE RELIABILITY
- * CATEGORIZED FOR LUMINOUS INTENSITY
- * **LEAD-FREE PACKAGE (ACCORDING TO ROHS)**

DESCRIPTION

The LTS-4802CB is a 0.4 inch (10.0 mm) digit height single digit seven-segment display. This device uses InGaN BLUE LED chips (InGaN epi on SiC substrate). The display has a gray face and white segments.

DEVICE

PART NO.	DESCRIPTION
InGaN BLUE	Common Anode
LTS-4802CB	Rt. Hand Decimal

PACKAGE DIMENSIONS

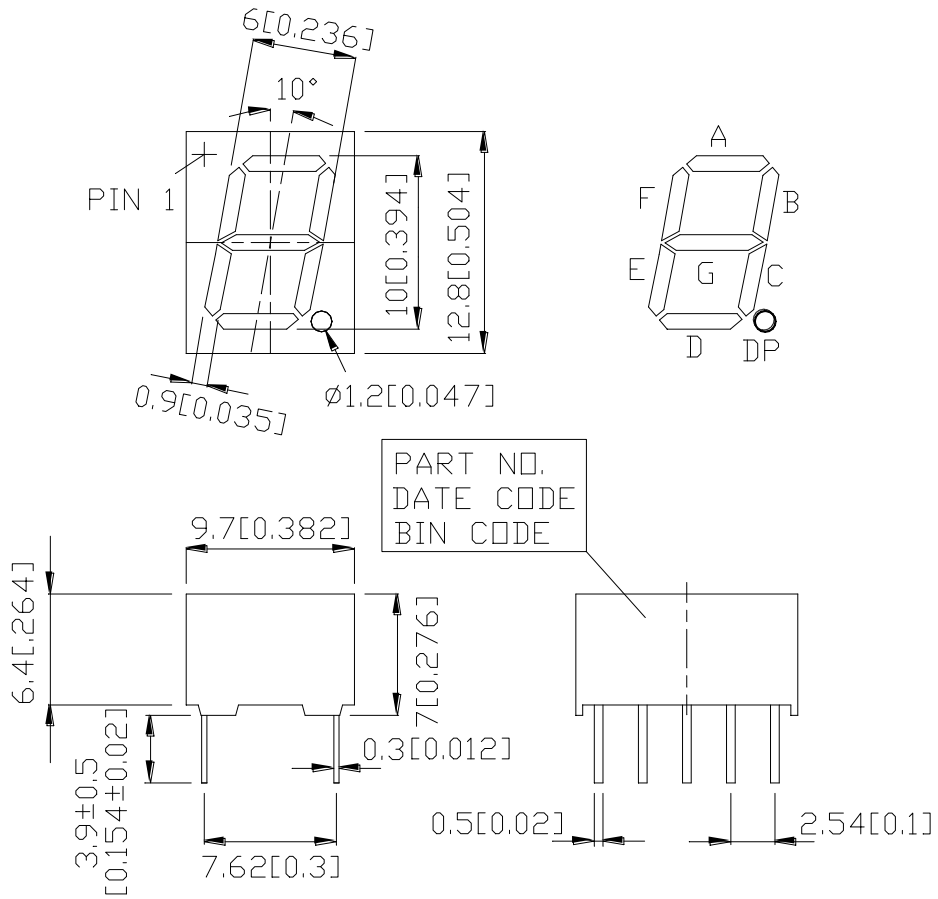

- NOTES: 1.All dimensions are in millimeters. Tolerances are ± 0.25 mm (0.01") unless otherwise noted.
 2.Pin tip's shift tolerance is ± 0.4 mm

INTERNAL CIRCUIT DIAGRAM

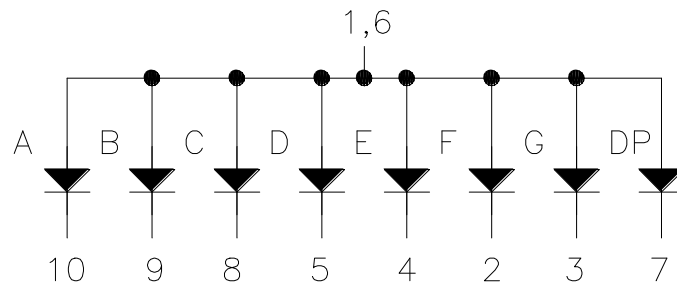

PIN CONNECTION

No.	CONNECTION
1	COMMON ANODE
2	CATHODE F
3	CATHODE G
4	CATHODE E
5	CATHODE D
6	COMMON ANODE
7	CATHODE C
8	CATHODE DP
9	CATHODE B
10	CATHODE A

ABSOLUTE MAXIMUM RATING

PARAMETER	MAXIMUM RATING	UNIT
Power Dissipation Per Segment	115	mW
Peak Forward Current Per Segment (Frequency 1Khz, 10% duty cycle)	60	mA
Continuous Forward Current Per Segment	30	mA
Forward Current Derating from 25 ⁰ C	0.33	mA/°C
Reverse Voltage Per Segment	5	V
Operating Temperature Range	-35°C to +105°C	
Storage Temperature Range	-35°C to +105°C	
Soldering condition: 1/16 inch below seating plane for 3 seconds at 260°C., or temperature of unit (during assembly) not over max. temperature rating above.		

ELECTRICAL / OPTICAL CHARACTERISTICS AT Ta=25°C

PARAMETER	SYMBOL	MIN.	TYP.	MAX.	UNIT	TEST CONDITION
Average Luminous Intensity Per Segment	IV	3400	7626		μcd	IF=10mA
Peak Emission Wavelength	λp		468		nm	IF=20mA
Spectral Line Half-Width	Δλ		25		nm	IF=20mA
Dominant Wavelength	λd		470		nm	IF=20mA
Forward Voltage Per Segment	V _F		3.3	3.7	V	IF=20mA
Reverse Current Per Segment	I _R			100	μA	V _R =5V
Luminous Intensity Matching Ratio (Similar Light Area)	I _v -m			2 : 1		IF=10mA

Note: Luminous intensity is measured with a light sensor and filter combination that approximates the CIE (Commision Internationale De L'Eclairage) eye-response curve.

TYPICAL ELECTRICAL / OPTICAL CHARACTERISTIC CURVES

(25°C Ambient Temperature Unless Otherwise Noted)

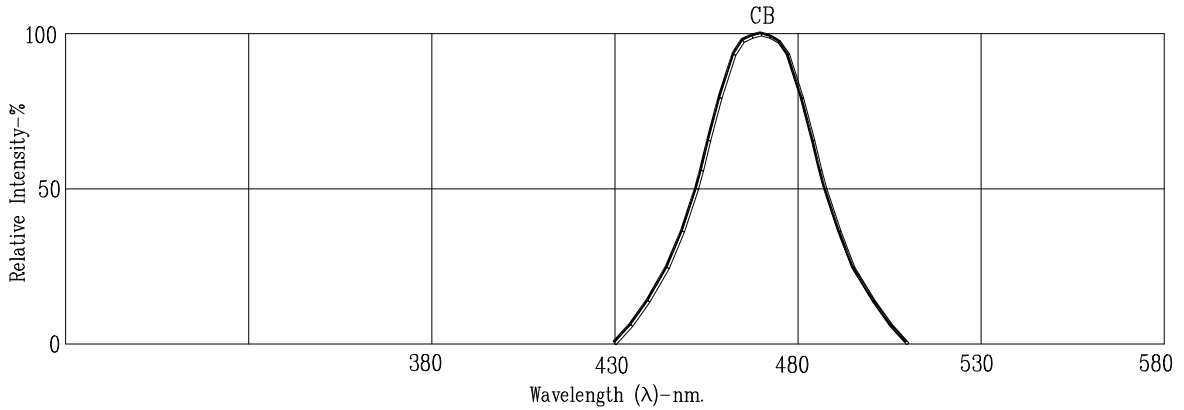

Fig1. RELATIVE INTENSITY VS. WAVELENGTH

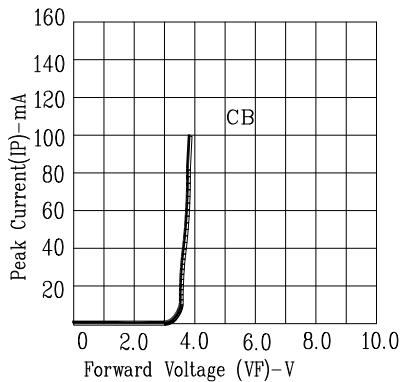

Fig3. FORWARD CURRENT VS. FORWARD VOLTAGE

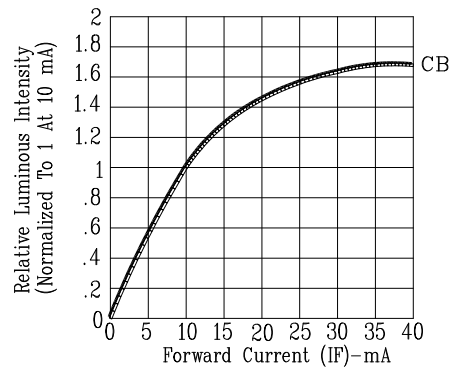

Fig4. RELATIVE LUMINOUS INTENSITY VS. FORWARD CURRENT

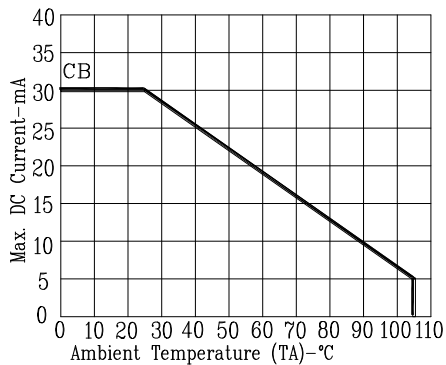

Fig5. MAX. ALLOWABLE DC CURRENT VS. AMBIENT TEMPERATURE.

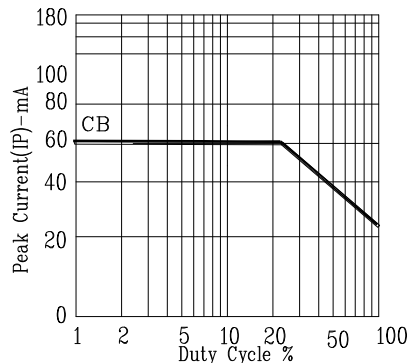

Fig6. MAX. PEAK CURRENT VS. DUTY CYCLE % (REFRESH RATE 1KHz)

NOTE: CB=InGaN Blue