



LED Display Product Data Sheet LTS-546AKS

Spec No.: DS30-2007-0198

Effective Date: 12/18/2007

Revision: -

LITE-ON DCC

RELEASE

BNS-OD-FC001/A4

LED DISPLAY

LTS-546AKS **DATASHEET**

<u>Rev</u>	<u>Description</u>	<u>By</u>
01	ORIGINAL	<u>WARIN</u> <u>Oct 3 .2007</u>
<u>Above data for PD and Customer tracking only</u>		
-	NPPR Received and Up load on OPNC	<u>WARIN</u> <u>Dec 4 .2007</u>

SPEC. NO.: DS30-2007-0198

D A T E : Dec 4 .2007

REV. NO. : -

PAGE NO. : 0 OF 5

FEATURES

- * 0.52 INCH (13.2-mm) DIGIT HEIGHT.
- * CONTINUOUS UNIFORM SEGMENTS.
- * LOW POWER REQUIREMENT.
- * EXCELLENT CHARACTERS APPEARANCE.
- * HIGH BRIGHTNESS & HIGH CONTRAST.
- * WIDE VIEWING ANGLE.
- * SOLID STATE RELIABILITY.
- * CATEGORIZED FOR LUMINOUS INTENSITY.
- * **LEAD-FREE PACKAGE (ACCORDING TO ROHS)**

DESCRIPTION

The LTS-546AKS is a 0.52-inch (13.2-mm) height single digit display. This device uses AS-AllnGaP Yellow LED chips (AllnGaP epi on GaAs substrate), and has a gray face and white segments.

DEVICE

PART NO.	DESCRIPTION
AllnGaP Yellow LED	Common Anode, Rt. Hand decimal
LTS-546AKS	

PACKAGE DIMENSIONS

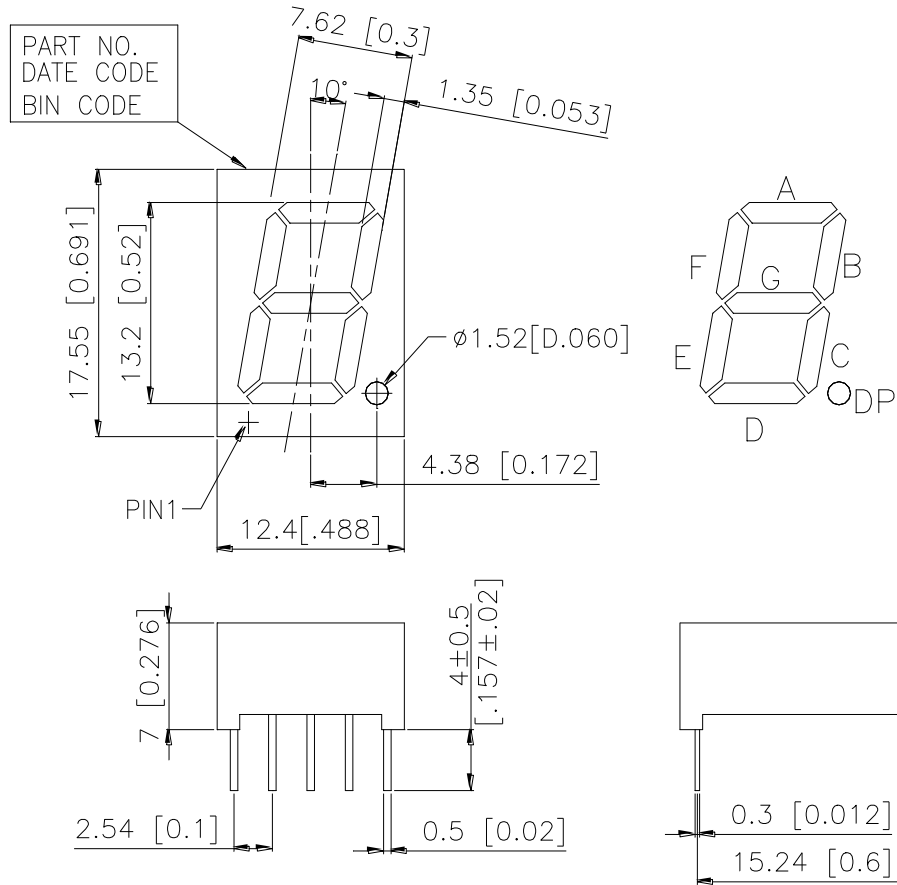

NOTES: 1.All dimensions are in millimeters. Tolerances are ± 0.25 -mm (0.01“) unless otherwise noted.
 2.Pin tip's shift are ± 0.40 mm .

INTERNAL CIRCUIT DIAGRAM

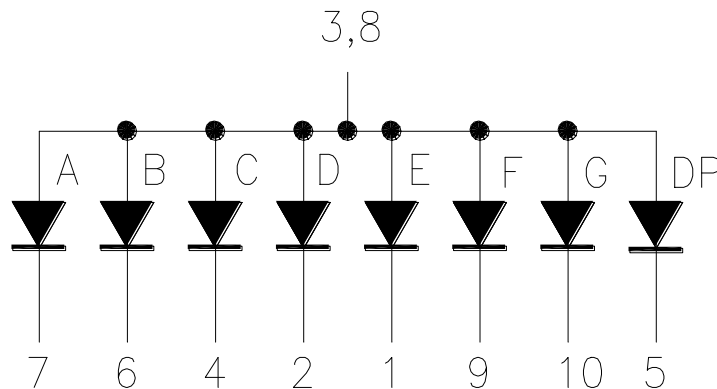

PIN CONNECTION

No.	CONNECTION
1	CATHODE E
2	CATHODE D
3	COMMON ANODE
4	CATHODE C
5	CATHODE D .P.
6	CATHODE B
7	CATHODE A
8	COMMON ANODE
9	CATHODE F
10	CATHODE G

ABSOLUTE MAXIMUM RATING

PARAMETER	MAXIMUM RATING	UNIT
Power Dissipation Per Chip	70	mW
Peak Forward Current Per Chip (Frequency 1Khz, 18% duty cycle)	60	mA
Continuous Forward Current Per Chip	25	mA
Forward Current Derating from 25 ⁰ C	0.33	mA/ ⁰ C
Reverse Voltage Per Chip	5	V
Operating Temperature Range	-35 ⁰ C to +105 ⁰ C	
Storage Temperature Range	-35 ⁰ C to +105 ⁰ C	

Soldering Conditions: 1/16 inch below seating plane for 3 seconds at 260⁰C

or of temperature unit (during assembly) not over max. temperature rating above.

ELECTRICAL / OPTICAL CHARACTERISTICS AT Ta=25⁰C

PARAMETER	SYMBOL	MIN.	TYP.	MAX.	UNIT	TEST CONDITION
Average Luminous Intensity Per Segment	I _v	500	1300		μcd	I _F =1mA
Peak Emission Wavelength	λ _p		588		nm	I _F =20mA
Spectral Line Half-Width	Δλ		15		nm	I _F =20mA
Dominant Wavelength	λ _d		587		nm	I _F =20mA
Forward Voltage Per Segment	V _F		2.05	2.6	V	I _F =20mA
Reverse Current Per Chip	I _R			100	μA	V _R =5V
Luminous Intensity Matching Ratio (Similar Light Area)	I _v -m			2:1		I _F =1mA

Note: Luminous intensity is measured with a light sensor and filter combination that approximates the CIE (Commision Internationale De L'Eclairage) eye-response curve.

TYPICAL ELECTRICAL / OPTICAL CHARACTERISTIC CURVES

(25°C Ambient Temperature Unless Otherwise Noted)

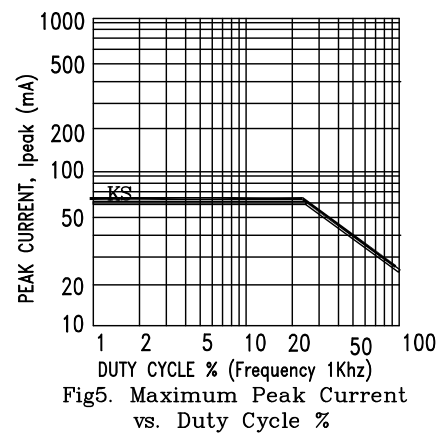
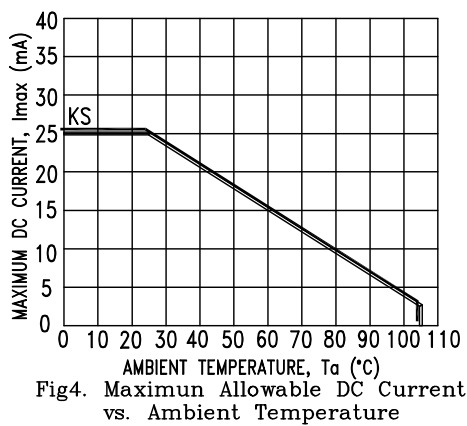
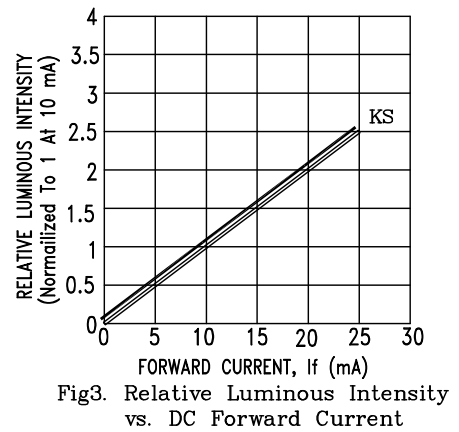
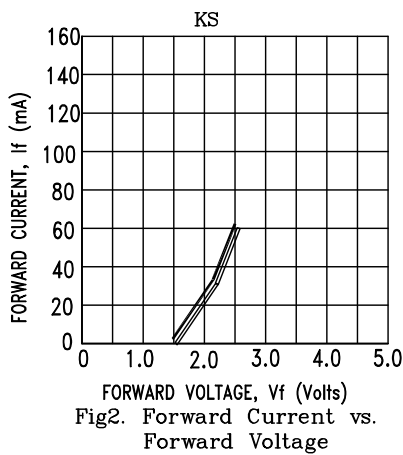
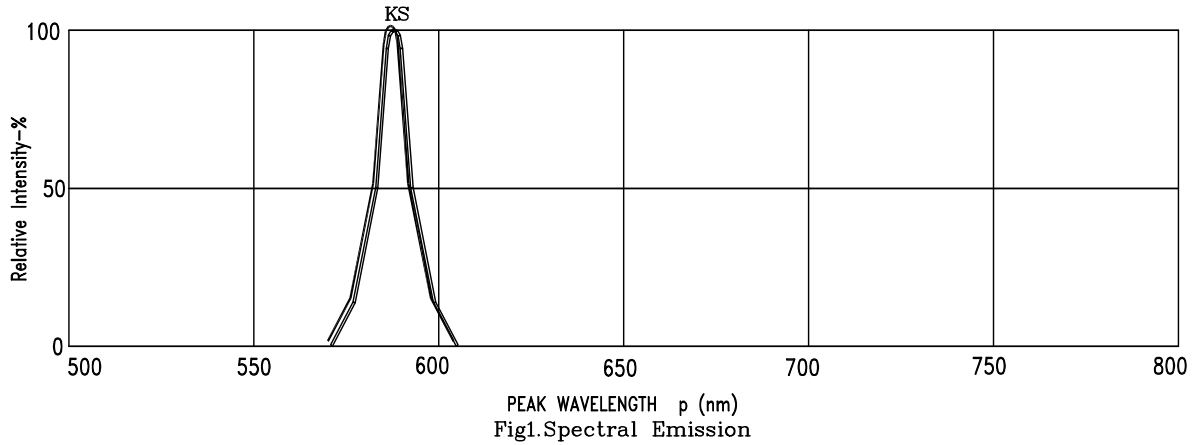

NOTE : KS=AlInGaP YELLOW