



LED Display Product Data Sheet LTS-50801KE

Spec No.: DS30-2008-0049

Effective Date: 03/21/2008

Revision: -

LITE-ON DCC

RELEASE

BNS-OD-FC001/A4

LED DISPLAY**LTS-50801KE
DATASHEET**

<u>Rev</u>	<u>Description</u>	<u>By</u>
01	ORIGINAL (Refer to contour drawing Revision (-))	<u>WARIN</u>
(Above data for PD and Customer tracking only)		
-	NPPR Received and Upload on OPNC	<u>KITTISAK</u> <u>Mar 08/2008</u>

SPEC. NO.: DS30-2008-0049DATE : Mar 08/2008REV. NO. : -PAGE NO. : 0 OF 5

FEATURES

- * 5-INCH (127.0 mm) DIGIT HEIGHT.
- * CONTINUOUS UNIFORM SEGMENTS.
- * LOW POWER REQUIREMENT.
- * EXCELLENT CHARACTERS APPEARANCE.
- * HIGH BRIGHTNESS & HIGH CONTRAST.
- * WIDE VIEWING ANGLE.
- * SOLID STATE RELIABILITY.
- * CATEGORIZED FOR LUMINOUS INTENSITY.
- * **LEAD-FREE PACKAGE (ACCORDING TO ROHS)**

DESCRIPTION

The LTS-50801KE is a 5-inch (127.0-mm) digit height single digit seven-segment display. This device uses AS-AlInGaP RED LED chips (AlInGaP epi on GaAs substrate). The display has a black face and white segments.

DEVICE

PART NO.	DESCRIPTION
AlInGaP RED	Common Anode
LTS-50801KE	

PACKAGE DIMENSIONS

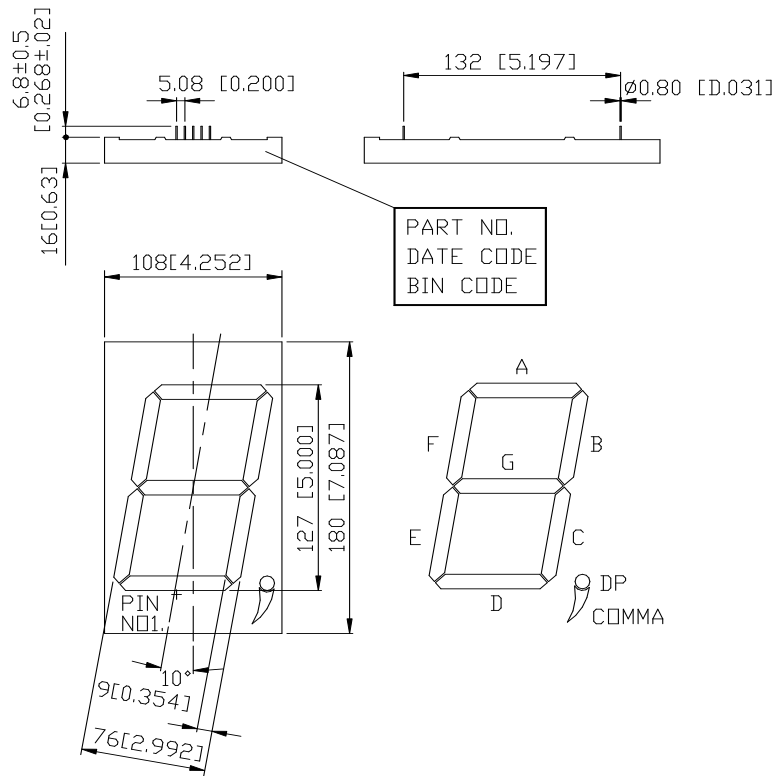

- NOTES: 1. All dimensions are in millimeters. Tolerance is ± 0.25 -mm (0.01") unless otherwise noted.
 2. Pin tip's shift tolerance is ± 0.4 mm.

INTERNAL CIRCUIT DIAGRAM

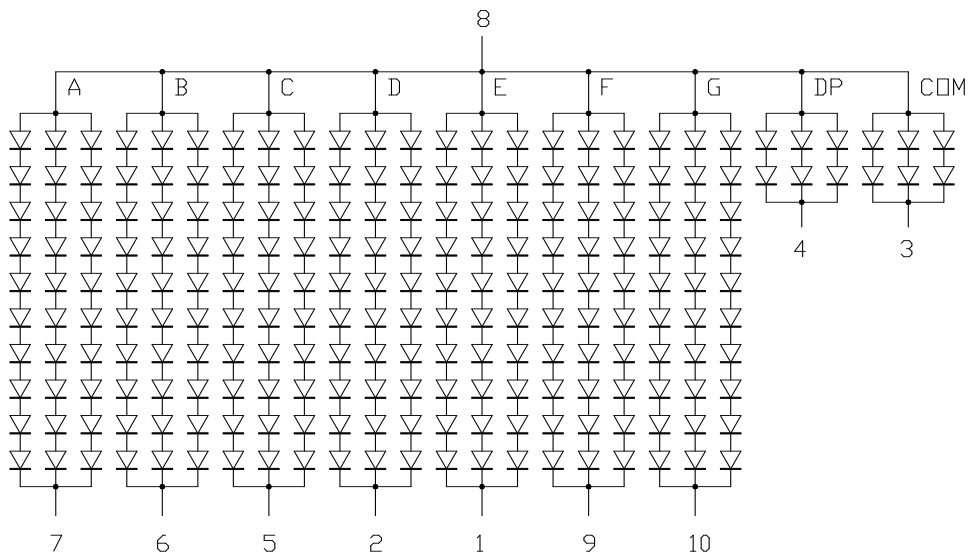

PIN CONNECTION

No.	CONNECTION
1	SEGMENT E CATHODE
2	SEGMENT D CATHODE
3	COMMA CATHODE
4	D.P. CATHODE
5	SEGMENT C CATHODE
6	SEGMENT B CATHODE
7	SEGMENT A CATHODE
8	COMMON ANODE
9	SEGMENT F CATHODE
10	SEGMENT G CATHODE

ABSOLUTE MAXIMUM RATING AT Ta=25°C

PARAMETER	MAXIMUM RATING	UNIT
Power Dissipation Per Segment	1400	mW
Peak Forward Current Per Segment (1/10 Duty Cycle, 0.1ms Pulse Width)	270	mA
Continuous Forward Current Per Segment Derating Linear From 25°C Per Segment	75	mA mA/°C
Reverse Voltage Per Segment	50	V
Operating Temperature Range	-35°C to +105°C	
Storage Temperature Range	-35°C to +105°C	
Soldering Conditions : 1/16 inch below seating plane for 3 seconds at 260°C., or temperature of unit (during assembly) not over max. temperature rating above		

ELECTRICAL / OPTICAL CHARACTERISTICS AT Ta=25°C

PARAMETER	SYMBOL	MIN.	TYP.	MAX.	UNIT	TEST CONDITION
Average Luminous Intensity	I _v		242		mcd	I _F =30mA
Peak Emission Wavelength	λ _p		632		nm	I _F =60mA
Spectral Line Half-Width	Δλ		20		nm	I _F =60mA
Dominant Wavelength	λ _d		624		nm	I _F =60mA
Forward Voltage Per Segment	V _F		20 (4)	26 (5.2)	V	I _F =60mA
Reverse Current Per Segment	I _R			300	μA	V _R =50V
Luminous Intensity Matching Ratio (Similar Light Area)	I _{v-m}			2:1		I _F =30mA

Note: Luminous intensity is measured with a light sensor and filter combination that approximates the CIE (Commision internationale DE L'Eclairage) eye-response curve.

TYPICAL ELECTRICAL / OPTICAL CHARACTERISTIC CURVES

(25°C Ambient Temperature Unless Otherwise Noted)

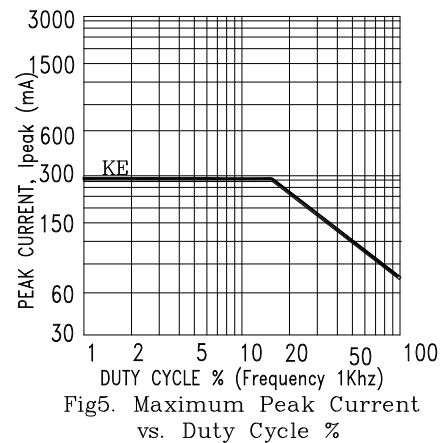
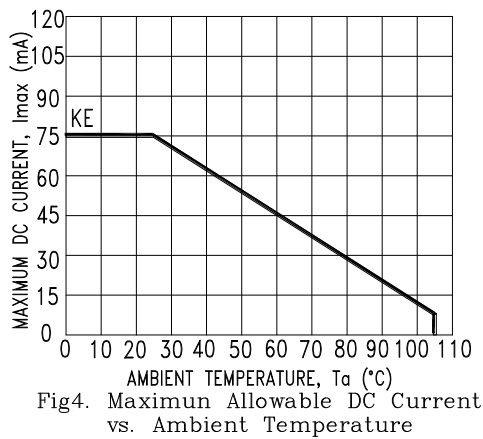
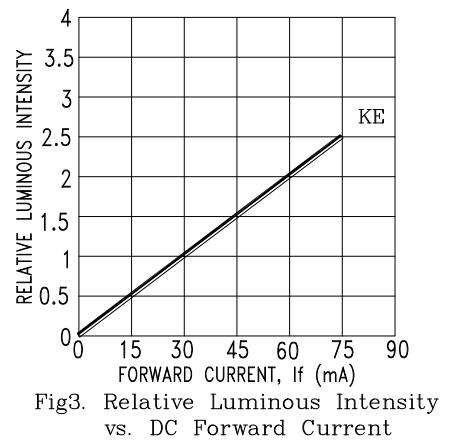
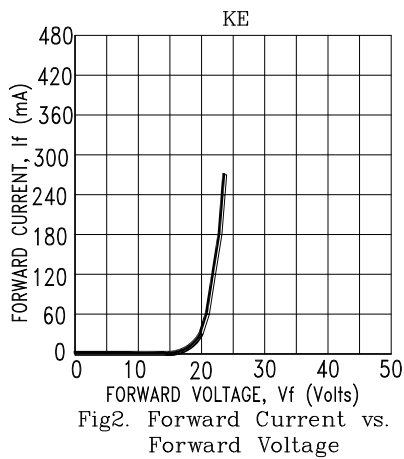
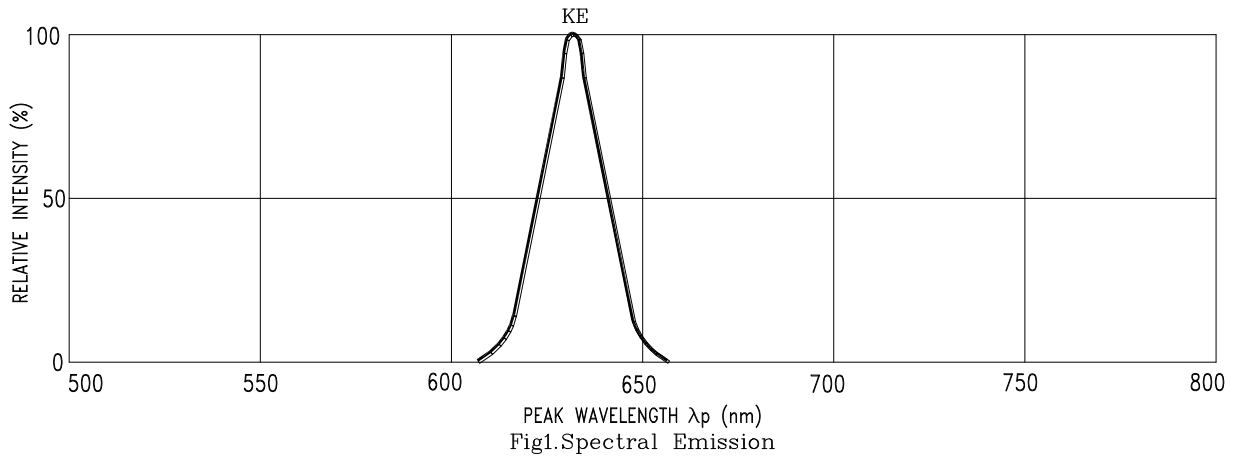

NOTE : KE=AlInGaP RED