



# LED Display Product Data Sheet LTS-2801ACB

Spec No.: DS30-2008-0153

Effective Date: 08/23/2008

Revision: -

**LITE-ON DCC**

**RELEASE**

BNS-OD-FC001/A4

**LED DISPLAY****LTS-2801ACB  
DATASHEET**

<u>Rev</u>	<u>Description</u>	<u>By</u>
1	ORIGINAL (Refer to contour drawing Revision (-))	<u>KITTISAK</u> 19 Nov .2007
(Above data for PD and Customer tracking only)		
-	NPPR Received and Upload on OPNC	<u>KITTISAK B.</u> <u>Aug 11. 2008</u>

SPEC. NO.: DS30-2008-0153DATE : Aug 11. 2008REV. NO. : -PAGE NO. : 0 OF 5

**FEATURES**

- \* 0.28-inch (7.0-mm) DIGIT HEIGHT.
- \* CONTINUOUS UNIFORM SEGMENTS.
- \* LOW POWER REQUIREMENT.
- \* EXCELLENT CHARACTERS APPEARANCE.
- \* HIGH BRIGHTNESS & HIGH CONTRAST.
- \* WIDE VIEWING ANGLE.
- \* SOLID STATE RELIABILITY.
- \* CATEGORIZED FOR LUMINOUS INTENSITY.
- \* **LEAD-FREE PACKAGE (ACCORDING TO ROHS)**

**DESCRIPTION**

The LTS-2801ACB is a 0.28-inch (7.0-mm) digit height single digit seven-segment display. This device uses InGaN BLUE LED chips (InGaN epi on SiC substrate), and has a gray face and white segments.

**DEVICE**

<b>PART NO.</b>	<b>DESCRIPTION</b>
InGaN BLUE	Common Anode
LTS-2801ACB	Rt. Hand Decimal

## PACKAGE DIMENSIONS

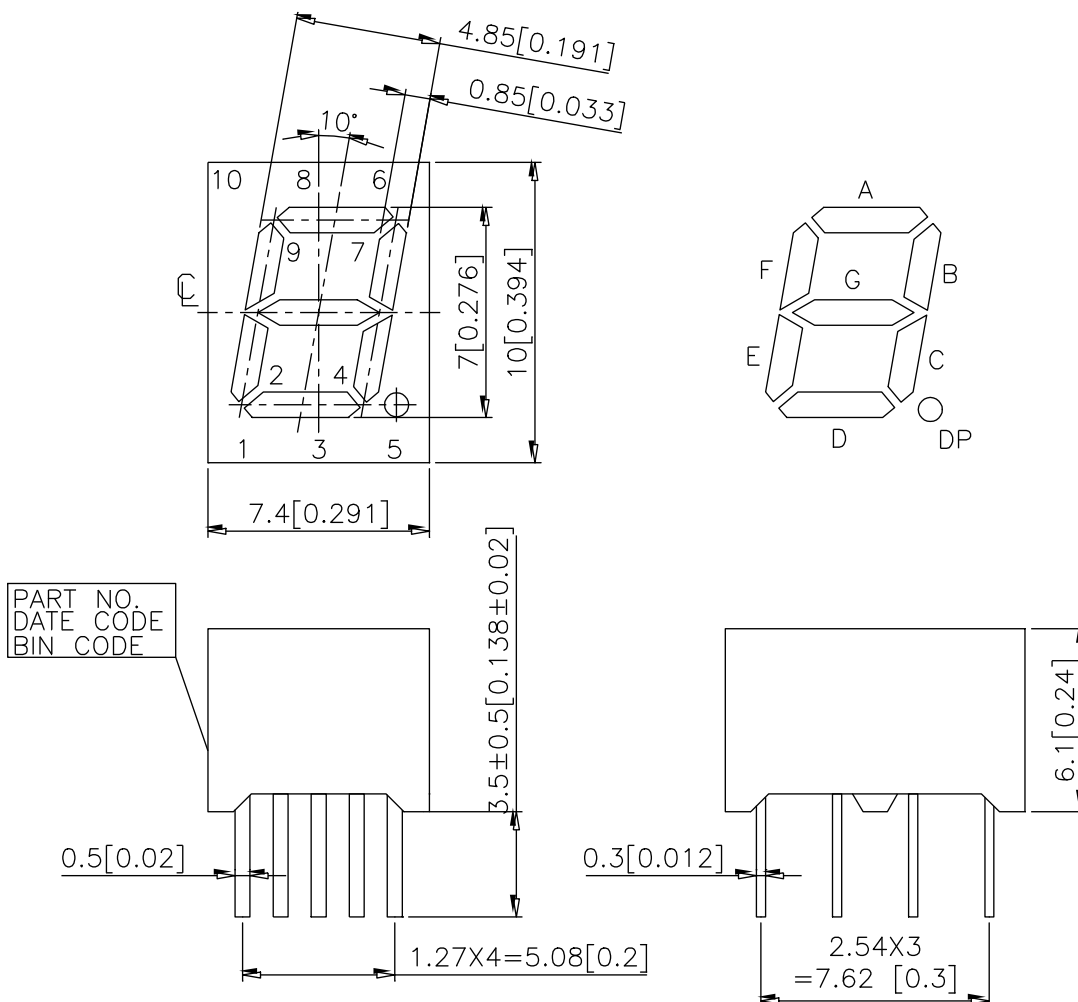

- NOTES: 1. All dimensions are in millimeters. Tolerances are ± 0.25 mm (0.01“) unless otherwise noted.  
 2. Pin tip's shift tolerance is ± 0.4 mm.

## INTERNAL CIRCUIT DIAGRAM

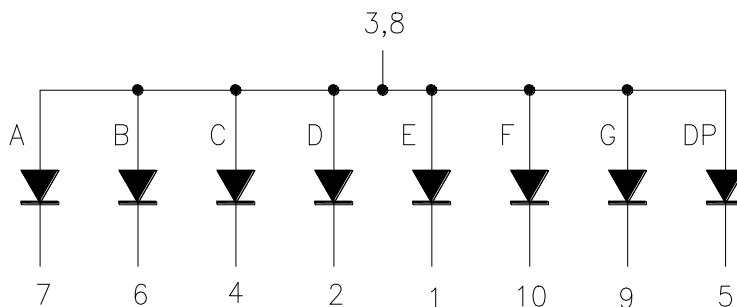

**PIN CONNECTION**

<b>No.</b>	<b>CONNECTION</b>
1	CATHODE E
2	CATHODE D
3	COMMON ANODE
4	CATHODE C
5	CATHODE D.P.
6	CATHODE B
7	CATHODE A
8	COMMON ANODE
9	CATHODE G
10	CATHODE F

**ABSOLUTE MAXIMUM RATING AT Ta=25°C**

PARAMETER	MAXIMUM RATING	UNIT
Power Dissipation Per Segment	115	mW
Peak Forward Current Per Segment ( Frequency 1Khz, 10% duty cycle)	60	mA
Continuous Forward Current Per Segment	30	mA
Forward Current Derating from 25°C	0.28	mA/°C
Reverse Voltage Per Segment	5	V
Operating Temperature Range	-35°C to +105°C	
Storage Temperature Range	-35°C to +105°C	
Soldering Conditions: 1/16 inch below seating plane for 3 seconds at 260°C., or temperature of unit (during assembly) not over max. temperature rating above		

**ELECTRICAL / OPTICAL CHARACTERISTICS AT Ta=25°C**

PARAMETER	SYMBOL	MIN	TYP	MAX	UNIT	TEST CONDITION
Average Luminous Intensity Per Segment	I <sub>v</sub>	5400	9000		μcd	I <sub>F</sub> = 10mA
Peak Emission Wavelength	λ <sub>p</sub>		468		nm	I <sub>F</sub> = 5mA
Spectral Line Half-Width	Δλ		25		nm	I <sub>F</sub> = 5mA
Dominant Wavelength	λ <sub>d</sub>	464	470	475	nm	I <sub>F</sub> = 5mA
Forward Voltage Per Segment	V <sub>F</sub>	2.5	-	3.5	V	I <sub>F</sub> = 5mA
Reverse Current Per Segment	I <sub>R</sub>			100	μA	V <sub>R</sub> = 5V
Luminous Intensity Matching Ratio (Similar Light Area)	I <sub>v</sub> -m			2 : 1		I <sub>F</sub> = 10mA

Note: Luminous intensity is measured with a light sensor and filter combination that approximates the CIE (Commision Internationale De L'Eclairage) eye-response curve.

**TYPICAL ELECTRICAL / OPTICAL CHARACTERISTIC CURVES**

(25°C Ambient Temperature Unless Otherwise Noted)

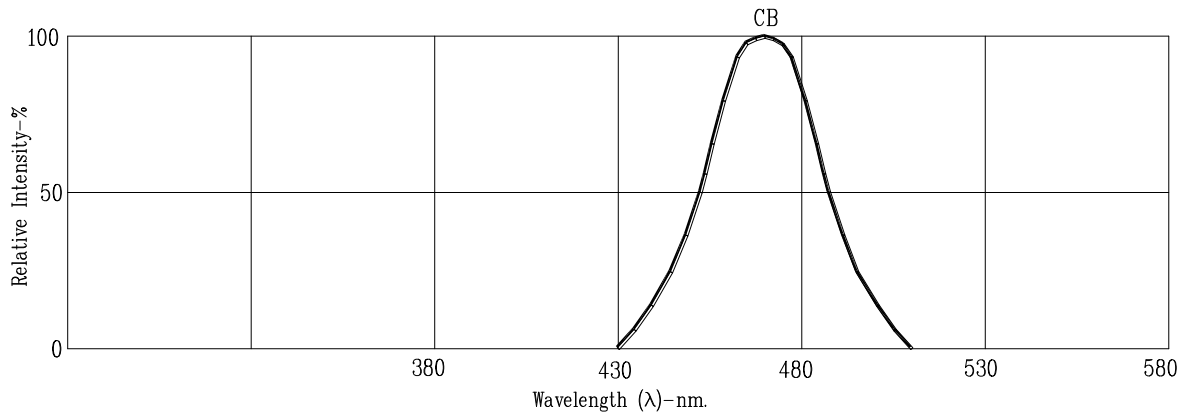

Fig1. RELATIVE INTENSITY VS. WAVELENGTH

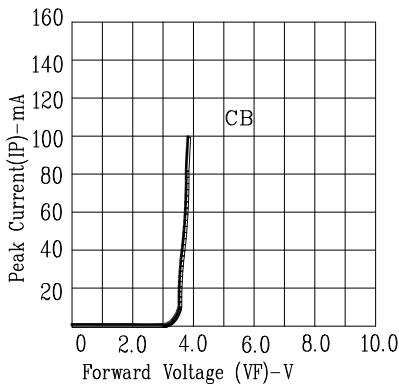

Fig3. FORWARD CURRENT VS. FORWARD VOLTAGE

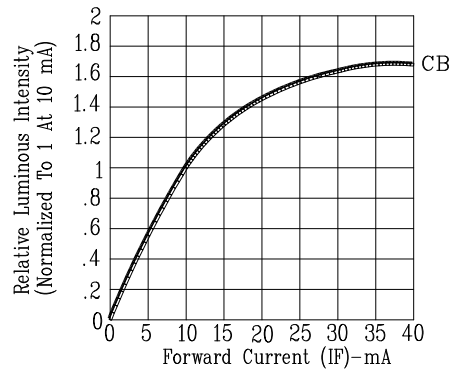

Fig4. RELATIVE LUMINOUS INTENSITY VS. FORWARD CURRENT

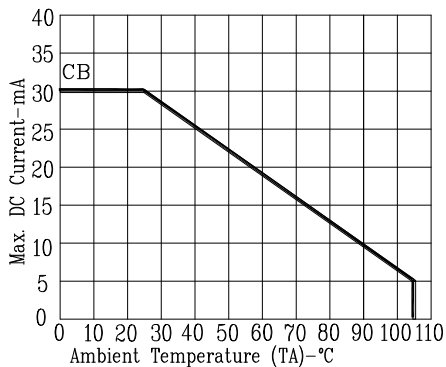

Fig5. MAX. ALLOWABLE DC CURRENT VS. AMBIENT TEMPERATURE.

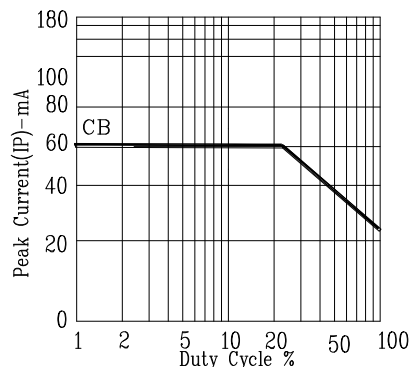

Fig6. MAX. PEAK CURRENT VS. DUTY CYCLE % (REFRESH RATE 1KHz)

NOTE: CB=InGaN Blue