



LED Display Product Data Sheet LTS-2301ACB

Spec No.: DS30-2008-0161

Effective Date: 09/27/2008

Revision: -

LITE-ON DCC

RELEASE

BNS-OD-FC001/A4

LED DISPLAY**LTS-2301ACB
DATASHEET**

| <u>Rev</u> | <u>Description</u> | <u>By</u> |
|--|---|--|
| 01 | ORIGINAL RDR | <u>WARIN S.</u> |
| | | |
| (Above data for PD and Customer tracking only) | | |
| - | NPPR Received and Upload on OPNC | <u>KITTISAK B.</u> <u>Sep 04/2008</u> |
| | | |
| | | |
| | | |

SPEC. NO.: DS30-2008-0161DATE : Sep 04/2008REV. NO. : -PAGE NO. : 0 OF 5

FEATURES

- * 0.28 inch (7.0-mm) DIGIT HEIGHT
- * CONTINUOUS UNIFORM SEGMENTS
- * LOW POWER REQUIREMENT
- * EXCELLENT CHARACTERS APPEARANCE
- * HIGH BRIGHTNESS & HIGH CONTRAST
- * WIDE VIEWING ANGLE
- * SOLID STATE RELIABILITY
- * CATEGORIZED FOR LUMINOUS INTENSITY
- * **LEAD-FREE PACKAGE (ACCORDING TO ROHS)**

DESCRIPTION

The LTS-2301ACB is a 0.28 inch (7-mm) digit height single digit seven-segment display . This device uses InGaN BLUE LED chips (InGaN epi on SiC substrate), and has a gray face and white segments.

DEVICE

| PART NO. | DESCRIPTION |
|-----------------|------------------------------------|
| InGaN BLUE | Common Cathode Rt. Hand Decimal |
| LTS-2301ACB | |

PACKAGE DIMENSIONS

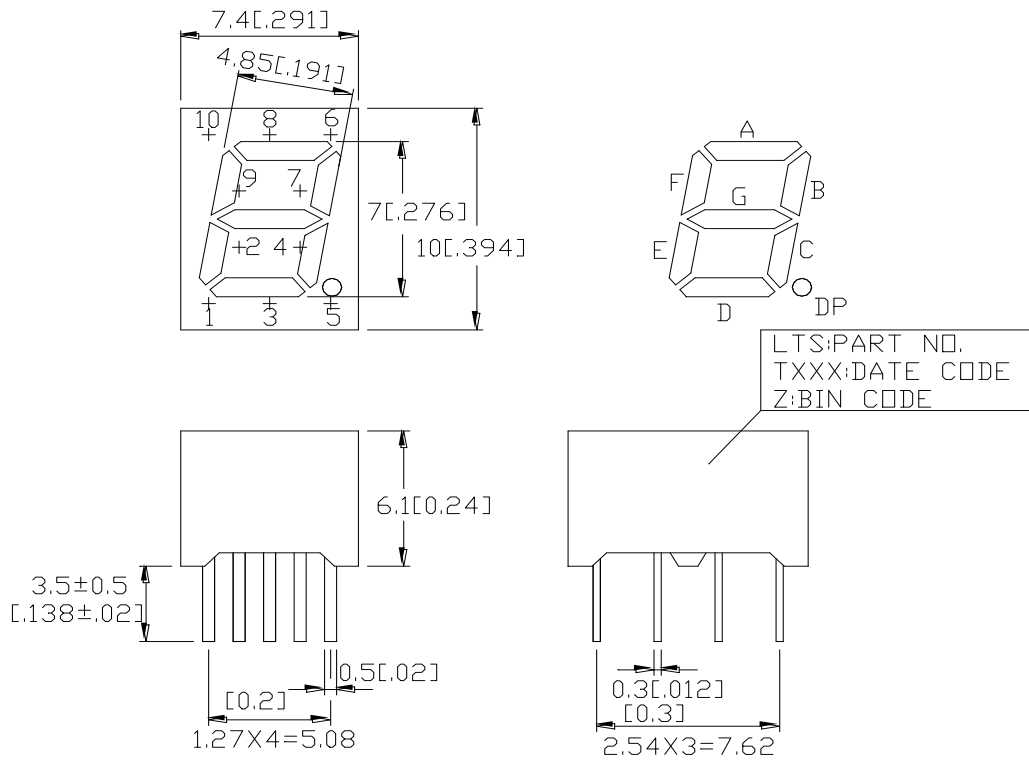

NOTES: 1. All dimensions are in millimeters. Tolerance is ± 0.25 mm (0.01") unless otherwise noted.

2. Pin tip's shift tolerance is ± 0.4 mm.

INTERNAL CIRCUIT DIAGRAM

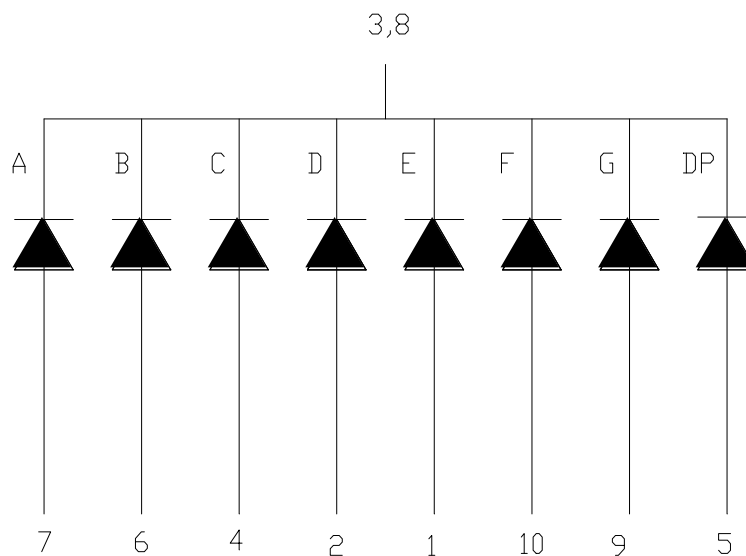

PIN CONNECTION

| No. | CONNECTION |
|------------|-------------------|
| 1 | ANODE E |
| 2 | ANODE D |
| 3 | COMMON CATHODE |
| 4 | ANODE C |
| 5 | ANODE D.P. |
| 6 | ANODE B |
| 7 | ANODE A |
| 8 | COMMON CATHODE |
| 9 | ANODE G |
| 10 | ANODE F |

ABSOLUTE MAXIMUM RATING AT Ta=25°C

| PARAMETER | MAXIMUM RATING | UNIT |
|---|-----------------|-------|
| Power Dissipation Per Segment | 115 | mW |
| Peak Forward Current Per Segment (Frequency 1Khz, 10% duty cycle) | 60 | mA |
| Continuous Forward Current Per Segment | 30 | mA |
| Forward Current Derating from 25°C | 0.16 | mA/°C |
| Reverse Voltage Per Segment | 5 | V |
| Operating Temperature Range | -35°C to +105°C | |
| Storage Temperature Range | -35°C to +105°C | |
| Soldering Conditions: 1/16 inch below seating plane for 3 seconds at 260°C., or temperature of unit (during assembly) not over max. temperature rating above | | |

ELECTRICAL / OPTICAL CHARACTERISTICS AT Ta=25°C

| PARAMETER | SYMBOL | MIN | TYP | MAX | UNIT | TEST CONDITION |
|---|-------------------|------|------|-------|------|-----------------------|
| Average Luminous Intensity Per Segment | I _v | 5400 | 9000 | | μcd | I _F = 10mA |
| Peak Emission Wavelength | λ _p | | 468 | | nm | I _F = 5mA |
| Spectral Line Half-Width | Δλ | | 25 | | nm | I _F = 5mA |
| Dominant Wavelength | λ _d | 464 | 470 | 475 | nm | I _F = 5mA |
| Forward Voltage Per Segment | V _F | 2.5 | - | 3.5 | V | I _F = 5mA |
| Reverse Current Per Segment | I _R | | | 100 | μA | V _R = 5V |
| Luminous Intensity Matching Ratio (Similar Light Area) | I _v -m | | | 2 : 1 | | I _F = 10mA |

Note: Luminous intensity is measured with a light sensor and filter combination that approximates the CIE (Commision Internationale De L'Eclairage) eye-response curve.

TYPICAL ELECTRICAL / OPTICAL CHARACTERISTIC CURVES

(25°C Ambient Temperature Unless Otherwise Noted)

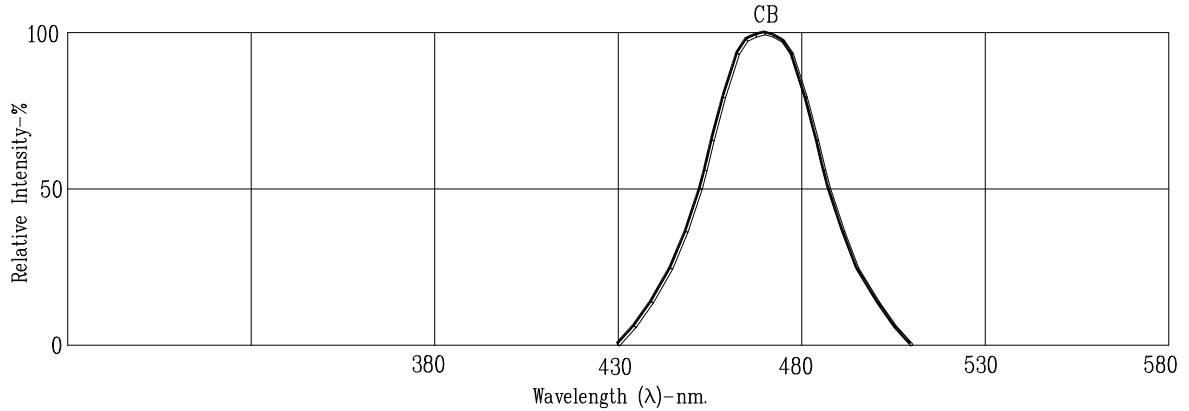

Fig1. RELATIVE INTENSITY VS. WAVELENGTH

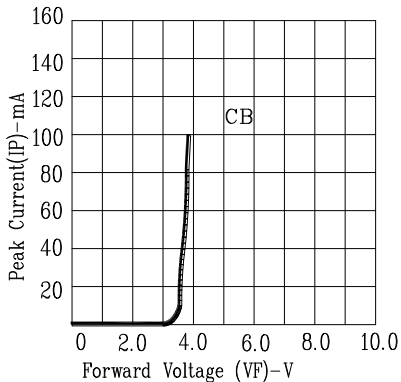

Fig3. FORWARD CURRENT VS. FORWARD VOLTAGE

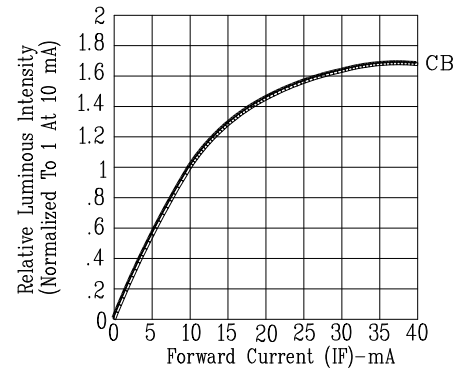

Fig4. RELATIVE LUMINOUS INTENSITY VS. FORWARD CURRENT

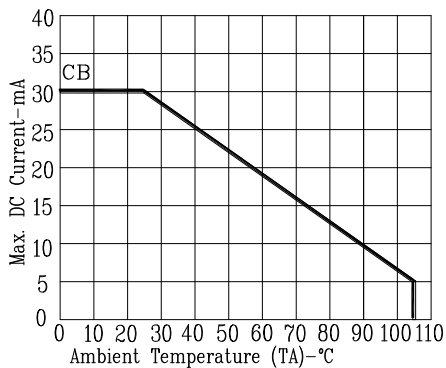

Fig5. MAX. ALLOWABLE DC CURRENT VS. AMBIENT TEMPERATURE.

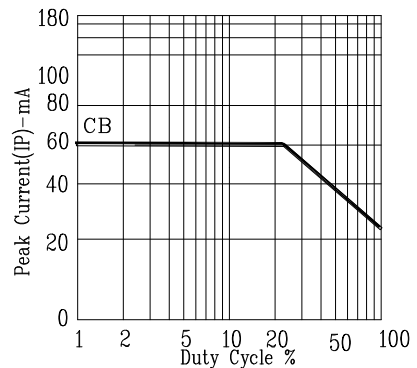

Fig6. MAX. PEAK CURRENT VS. DUTY CYCLE % (REFRESH RATE 1KHz)

NOTE: CB=InGaN Blue