



LED Display Product Data Sheet LTS-10101TBE

Spec No.: DS30-2010-0161

Effective Date: 07/20/2013

Revision: A

LITE-ON DCC

RELEASE

BNS-OD-FC001/A4

FEATURES

- * 1.0 inch (25.40 mm) DIGIT HEIGHT.
- * CONTINUOUS UNIFORM SEGMENTS.
- * LOW POWER REQUIREMENT.
- * EXCELLENT CHARACTERS APPEARANCE.
- * HIGH BRIGHTNESS & HIGH CONTRAST.
- * WIDE VIEWING ANGLE.
- * SOLID STATE RELIABILITY.
- * CATEGORIZED FOR LUMINOUS INTENSITY.
- * **LEAD-FREE PACKAGE (ACCORDING TO ROHS)**

DESCRIPTION

The LTS-10101TBE is a 1.0 inch (25.40mm) digit height single digit seven-segment display. This device utilizes InGaN blue chips, which are made from InGaN on Sapphire substrate, and has a gray face and white segments.

DEVICE

PART NO.	DESCRIPTION
InGaN Blue	UNIVERSAL
LTS-10101TBE	

PACKAGE DIMENSIONS

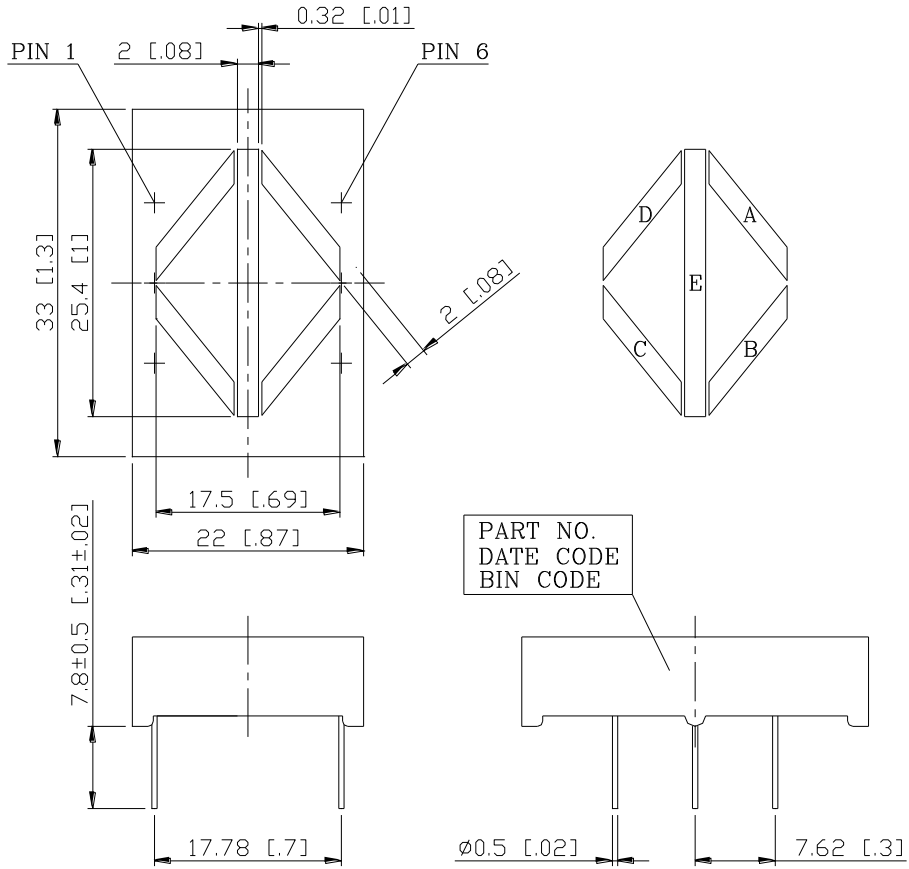

NOTES: 1. All dimensions are in millimeters. Tolerances are ± 0.25 mm (0.01“) unless otherwise noted.
 2. Pin tip’s shift tolerance is ± 0.4 mm.

INTERNAL CIRCUIT DIAGRAM

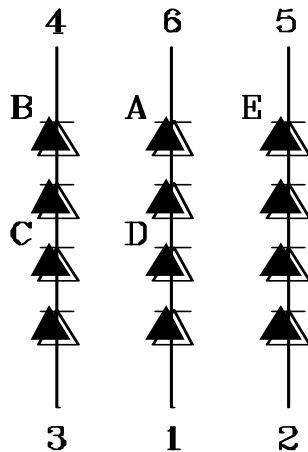

PIN CONNECTION

No.	CONNECTION
1	ANODE A,D
2	ANODE E
3	ANODE B,C
4	CATHODE B,C
5	CATHODE E
6	CATHODE A,D

ABSOLUTE MAXIMUM RATING AT Ta=25°C

PARAMETER	MAXIMUM RATING	UNIT
Power Dissipation Per Chip	334	mW
Peak Forward Current Per Chip (1/10 Duty Cycle, 0.1ms Pulse Width)	100	mA
Continuous Forward Current Per Chip	20	mA
Derating Linear From 25°C Per Chip	0.22	mA/°C
Operating Temperature Range	-35°C to +85°C	
Storage Temperature Range	-35°C to +85°C	
Solder Temperature: max 260°C for max 3sec at 1.6mm[1/16inch] below seating plane.		

ELECTRICAL / OPTICAL CHARACTERISTICS AT Ta=25°C

PARAMETER	SYMBOL	MIN.	TYP.	MAX.	UNIT	TEST CONDITION
Average Luminous Intensity Per Segment	I _v	17.4	54.9		mcd	I _F =10mA
Peak Emission Wavelength	λ _p		468		nm	I _F =20mA
Spectral Line Half-Width	Δλ		25		nm	I _F =20mA
Dominant Wavelength	λ _d		470		nm	I _F =20mA
Forward Voltage Per Segment	V _F		13.2	14.4	V	I _F =20mA
Reverse Current Per Segment	I _R			100	μA	V _R =5V
Luminous Intensity Matching Ratio	I _v -m			2:1		I _F =1mA

Note: 1. Luminous intensity is measured with a light sensor and filter combination that approximates the CIE (Commission Internationale De L'Eclairage) eye-response curve.
 2. Reverse voltage is only for IR test. It can not continue to operate at this situation.

ESD (Electrostatic Discharge)

Static Electricity or power surge will damage the LED. Suggestions to prevent ESD damage:

- Use of a conductive wrist band or anti-electrostatic glove when handling these LEDs.
- All devices, equipment, and machinery must be properly grounded.
- Work tables, storage racks, etc. should be properly grounded.
- Use ion blower to neutralize the static charge which might have built up on surface of the LED's plastic lens as a result of friction between LEDs during storage and handling.

TYPICAL ELECTRICAL / OPTICAL CHARACTERISTIC CURVES

(25°C Ambient Temperature Unless Otherwise Noted)

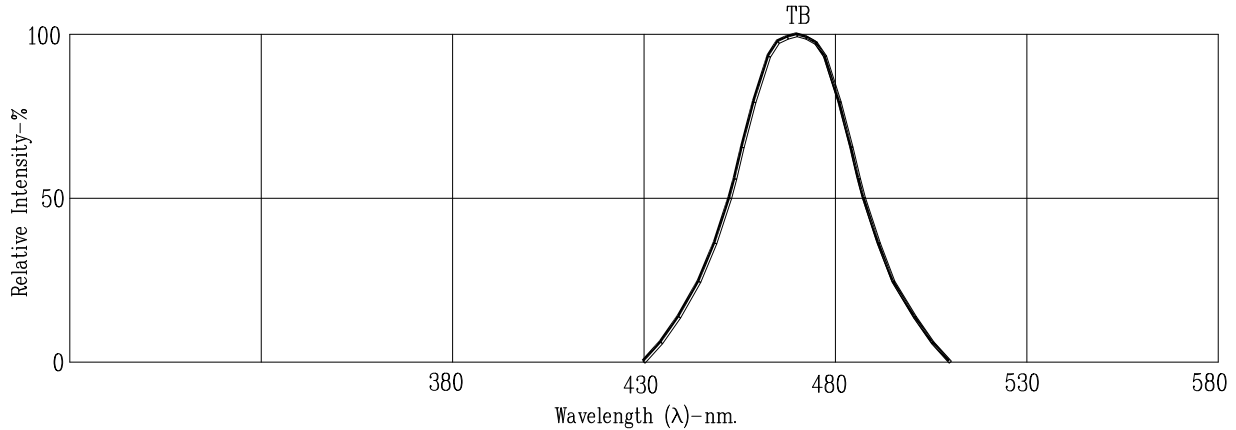

Fig1. RELATIVE INTENSITY VS. WAVELENGTH

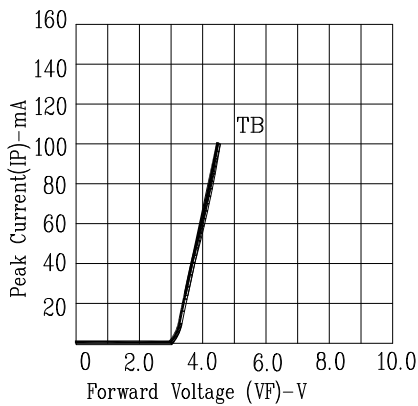

Fig3. FORWARD CURRENT VS. FORWARD VOLTAGE

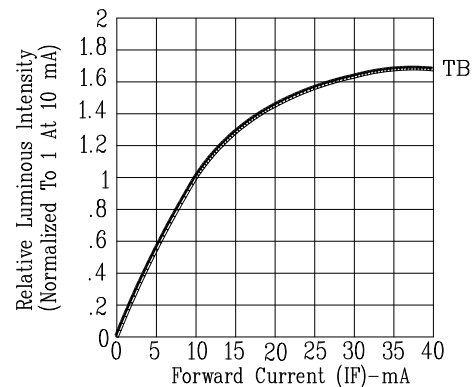

Fig4. RELATIVE LUMINOUS INTENSITY VS. FORWARD CURRENT

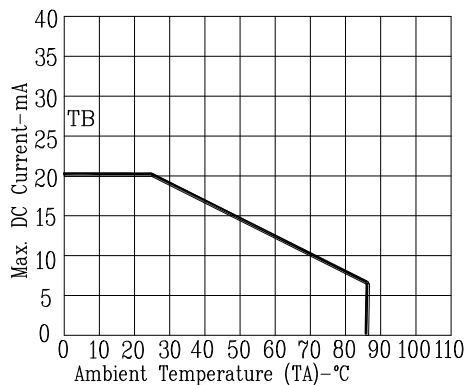

Fig5. MAX. ALLOWABLE DC CURRENT VS. AMBIENT TEMPERATURE.

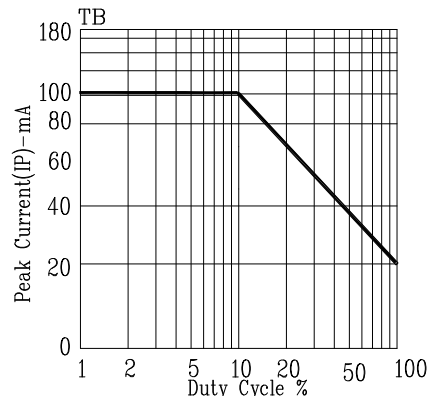

Fig6. MAX. PEAK CURRENT VS. DUTY CYCLE % (REFRESH RATE 1KHz)

NOTE: TB=InGaN/sapphire Blue