



# LED Display Product Data Sheet LTS-2301AC-15

Spec No.: DS30-2010-0201

Effective Date: 11/10/2010

Revision: A

**LITE-ON DCC**

**RELEASE**

BNS-OD-FC001/A4

**LED DISPLAY****LTS-2301AC-15**  
**DATA SHEET**

<b><u>Item</u></b>	<b><u>Description</u></b>	<b><u>By</u></b>	<b><u>DATE</u></b>
1	New Spec	Eason Lin	2010/08/24
2	Correct Outline dimension	Eason Lin	2010/10/20

**FEATURES**

- \* 0.28 inch (7.0mm) DIGIT HEIGHT.
- \* CONTINUOUS UNIFORM SEGMENTS.
- \* LOW POWER REQUIREMENT.
- \* EXCELLENT CHARACTERS APPEARANCE.
- \* HIGH BRIGHTNESS & HIGH CONTRAST.
- \* WIDE VIEWING ANGLE.
- \* SOLID STATE RELIABILITY.
- \* CATEGORIZED FOR LUMINOUS INTENSITY.
- \* **LEAD-FREE PACKAGE (ACCORDING TO ROHS).**

**DESCRIPTION**

The LTS-2301AC-15 is a 0.28inch (7.0mm) digit height single digit seven-segment display. This device utilizes AlGaAs red LED chips, which are made from AlGaAs on a non-transparent GaAs substrate, and has a gray face and white segments. Four sides are painted gray with gray ink.

**DEVICE**

<b>PART NO.</b>	<b>DESCRIPTION</b>
AlGaAs RED	Common Cathode
LTS-2301AC-15	Rt. Hand Decimal

## PACKAGE DIMENSIONS

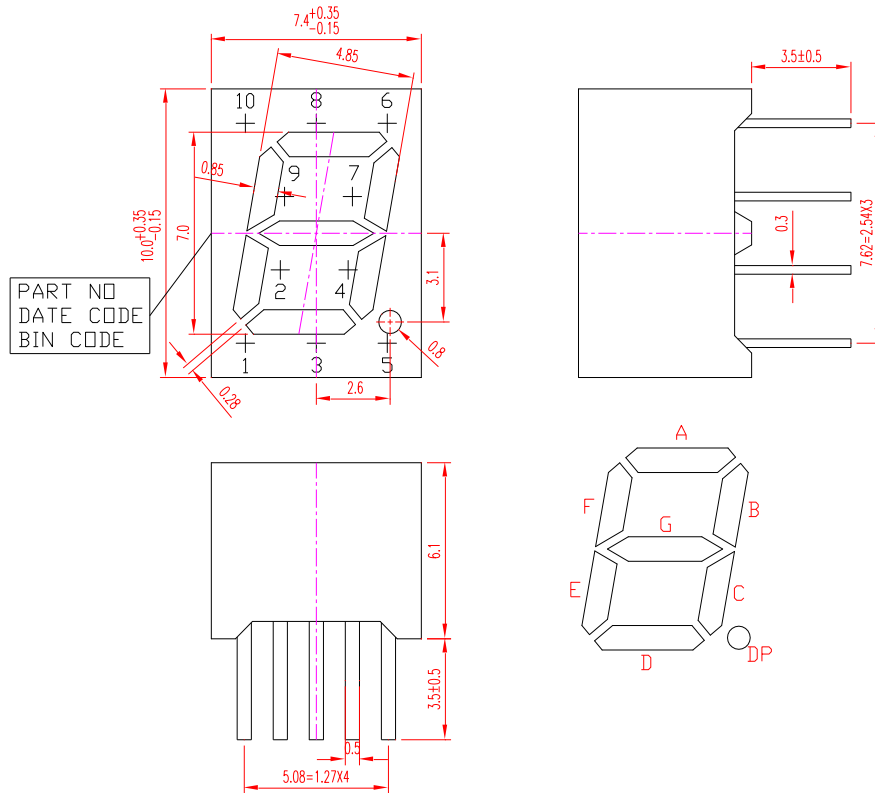

### NOTES:

1. All dimensions are in millimeters. Tolerance is  $\pm 0.25$  mm (0.01") unless otherwise noted.
2. Pin tip's shift tolerance is  $\pm 0.40$  mm.

## INTERNAL CIRCUIT DIAGRAM

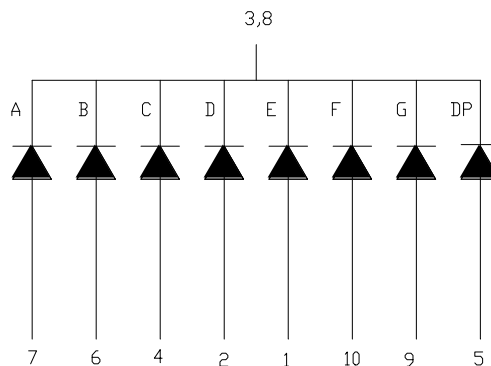

**PIN CONNECTION**

<b>No.</b>	<b>CONNECTION</b>
1	ANODE E
2	ANODE D
3	COMMON CATHODE
4	ANODE C
5	ANODE D.P.
6	ANODE B
7	ANODE A
8	COMMON CATHODE
9	ANODE G
10	ANODE F

**ABSOLUTE MAXIMUM RATING AT T<sub>A</sub>=25°C**

PARAMETER	MAXIMUM RATING	UNIT
Power Dissipation Per Segment	75	mW
Peak Forward Current Per Segment ( 1/10 Duty Cycle, 0.1ms Pulse Width )	125	mA
Continuous Forward Current Per Segment Derating Linear From 25 ° C Per Segment	30 0.4	mA mA/° C
Operating Temperature Range	-35 ° C to +85 ° C	
Storage Temperature Range	-35 ° C to +85 ° C	
Solder Temperature: max 260 ° C for max 3sec at 1.6mm below seating plane.		

**ELECTRICAL / OPTICAL CHARACTERISTICS AT T<sub>A</sub>=25°C**

PARAMETER	SYMBOL	MIN.	TYP.	MAX.	UNIT	TEST CONDITION
Average Luminous Intensity	I <sub>v</sub>	2100	6000		μcd	I <sub>F</sub> =10mA
Peak Emission Wavelength	λ <sub>p</sub>		660		nm	I <sub>F</sub> =20mA
Spectral Line Half-Width	Δλ		35		nm	I <sub>F</sub> =20mA
Dominant Wavelength	λ <sub>d</sub>		638		nm	I <sub>F</sub> =20mA
Forward Voltage Per Segment	V <sub>F</sub>		1.8	2.4	V	I <sub>F</sub> =20mA
Reverse Current Per Segment <sup>(2)</sup>	I <sub>R</sub>			100	μA	V <sub>R</sub> =5V
Luminous Intensity Matching Ratio	I <sub>v</sub> -m			2:1		I <sub>F</sub> =10mA

Note:

1. Luminous intensity is measured with a light sensor and filter combination that approximates the CIE (commission international DE L'clairage) eye-response curve.
2. Reverse voltage is only for IR test. It can not continue to operate at this situation.

**TYPICAL ELECTRICAL / OPTICAL CHARACTERISTIC CURVES**

(25°C Ambient Temperature Unless Otherwise Noted)

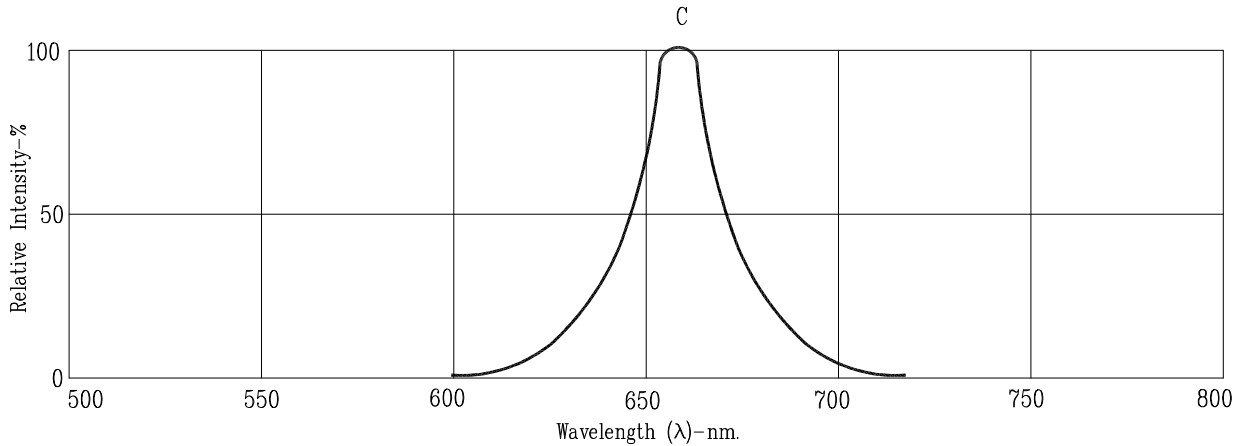

Fig1. RELATIVE INTENSITY VS. WAVELENGTH

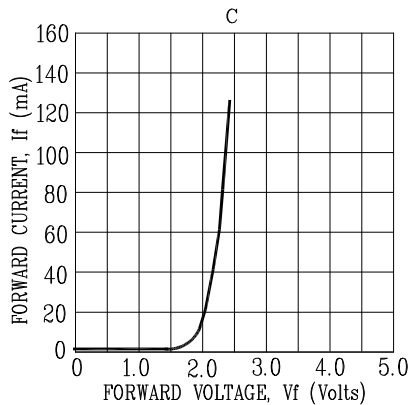

Fig2. Forward Current vs. Forward Voltage

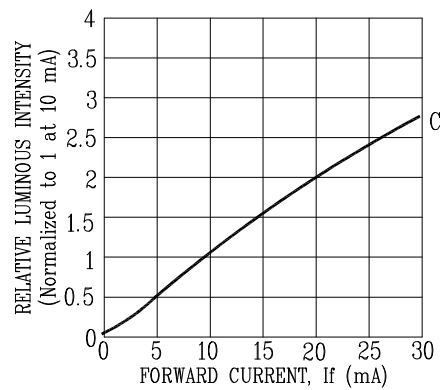

Fig3. Relative Luminous Intensity vs. DC Forward Current

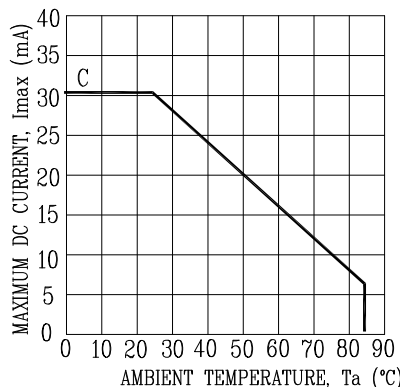

Fig4. Maximum Allowable DC Current vs. Ambient Temperature

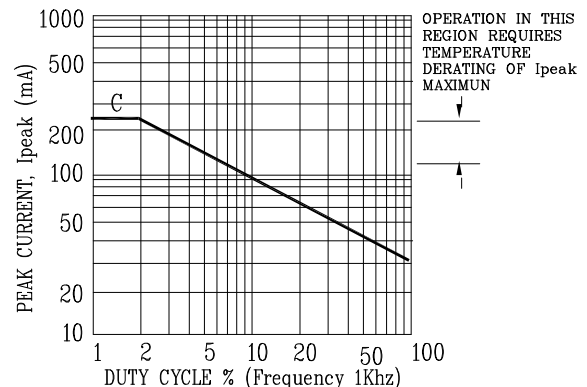

Fig5. Maximum Peak Current vs. Duty Cycle %

NOTE: C=AlGaAs RED