



LED Display

Product Data Sheet

LTS-546AKF

Spec No.: DS30-2010-0245

Effective Date: 11/02/2010

Revision: -

LITE-ON DCC

RELEASE

BNS-OD-FC001/A4

LED DISPLAY**LTS-546AKF**
DATASHEET

<u>Item</u>	<u>Description</u>	<u>By</u>	<u>DATE</u>
-	New Spec	Eason Lin	07/27/2010

FEATURES

- * 0.52 inch (13.2 mm) DIGIT HEIGHT
- * CONTINUOUS UNIFORM SEGMENTS
- * LOW POWER REQUIREMENT
- * EXCELLENT CHARACTERS APPEARANCE
- * HIGH BRIGHTNESS & HIGH CONTRAST
- * WIDE VIEWING ANGLE
- * SOLID STATE RELIABILITY
- * CATEGORIZED FOR LUMINOUS INTENSITY
- * **LEAD-FREE PACKAGE (ACCORDING TO ROHS)**

DESCRIPTION

The LTS-546AKF is a 0.52 inch (13.2 mm) digit height single digit seven-segment display. This device uses AlInGaP Yellow Orange LED chips, which are made from AlInGaP on a non-transparent GaAs substrate. The display has gray face and white segments.

DEVICE

PART NO.	DESCRIPTION
AlInGaP Yellow Orange	Common Anode
LTS-546AKF	Rt. Hand Decimal

PACKAGE DIMENSIONS

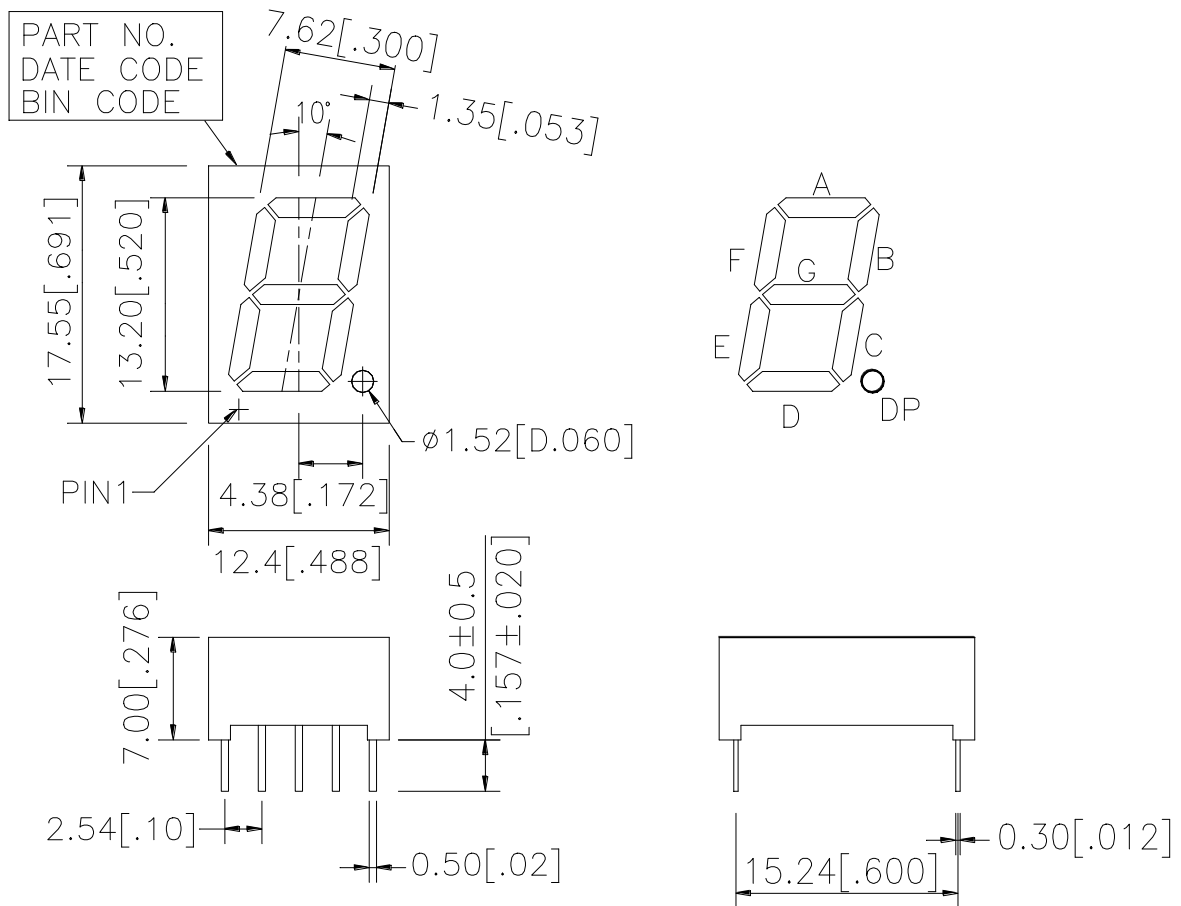

NOTES: All dimensions are in millimeters. Tolerances are ± 0.25 mm (0.01") unless otherwise noted.

INTERNAL CIRCUIT DIAGRAM

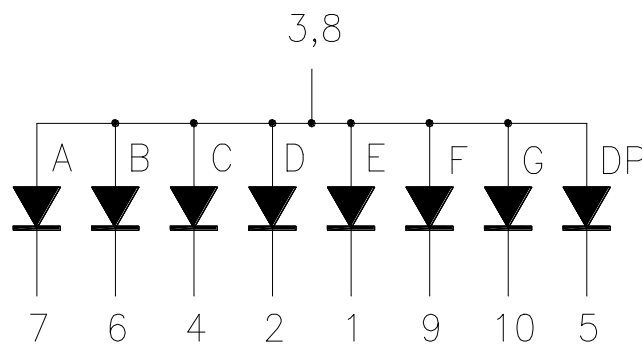

PIN CONNECTION

No.	CONNECTION
1	CATHODE E
2	CATHODE D
3	COMMON ANODE
4	CATHODE C
5	CATHODE D.P.
6	CATHODE B
7	CATHODE A
8	COMMON ANODE
9	CATHODE F
10	CATHODE G

ABSOLUTE MAXIMUM RATING

PARAMETER	MAXIMUM RATING	UNIT
Power Dissipation Per Segment	70	mW
Peak Forward Current Per Segment (Frequency 1Khz, 10% duty cycle)	60	mA
Continuous Forward Current Per Segment	25	mA
Forward Current Derating from 25°C	0.33	mA/°C
Operating Temperature Range	-35°C to +85°C	
Storage Temperature Range	-35°C to +85°C	
Soldering Conditions : 1/16 inch below seating plane for 3 seconds at 260°C		

ELECTRICAL / OPTICAL CHARACTERISTICS AT Ta=25°C

PARAMETER	SYMBOL	MIN.	TYP.	MAX.	UNIT	TEST CONDITION
Average Luminous Intensity	I _v	500	1400		μcd	I _F =1mA
Peak Emission Wavelength	λ _p		611		nm	I _F =20mA
Spectral Line Half-Width	Δλ		17		nm	I _F =20mA
Dominant Wavelength	λ _d		605		nm	I _F =20mA
Forward Voltage Per Segment	V _F		2.05	2.6	V	I _F =20mA
Reverse Current Per Segment ⁽²⁾	I _R			100	μA	V _R =5V
Luminous Intensity Matching Ratio (Similar Light Area)	I _v -m			2:1		I _F =1mA

Note:

1. Luminous intensity is measured with a light sensor and filter combination that approximates the CIE (Commision Internationale De L'Eclairage) eye-response curve.
2. Reverse voltage is only for IR test. It can not continue to operate at this situation.

TYPICAL ELECTRICAL / OPTICAL CHARACTERISTIC CURVES

(25°C Ambient Temperature Unless Otherwise Noted)

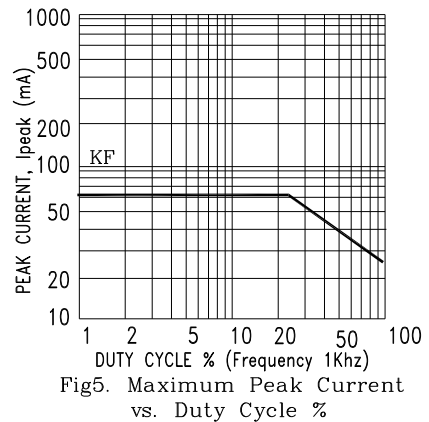
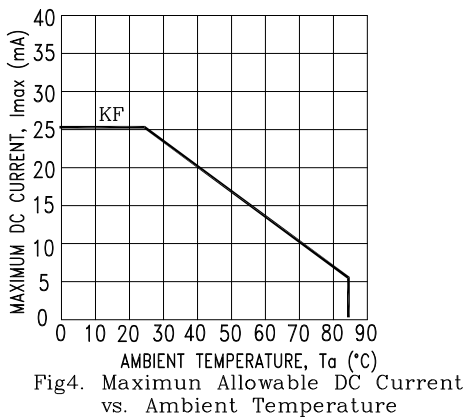
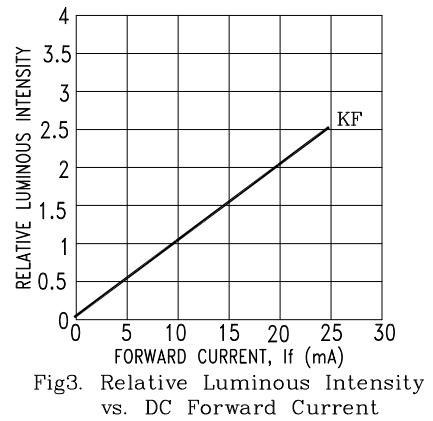
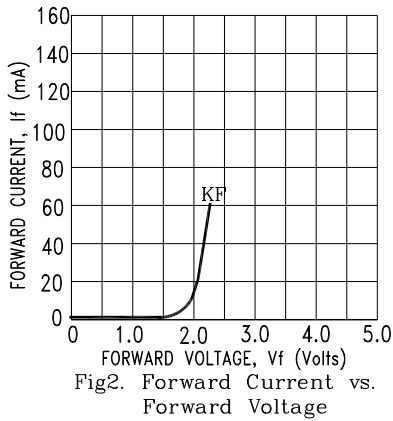
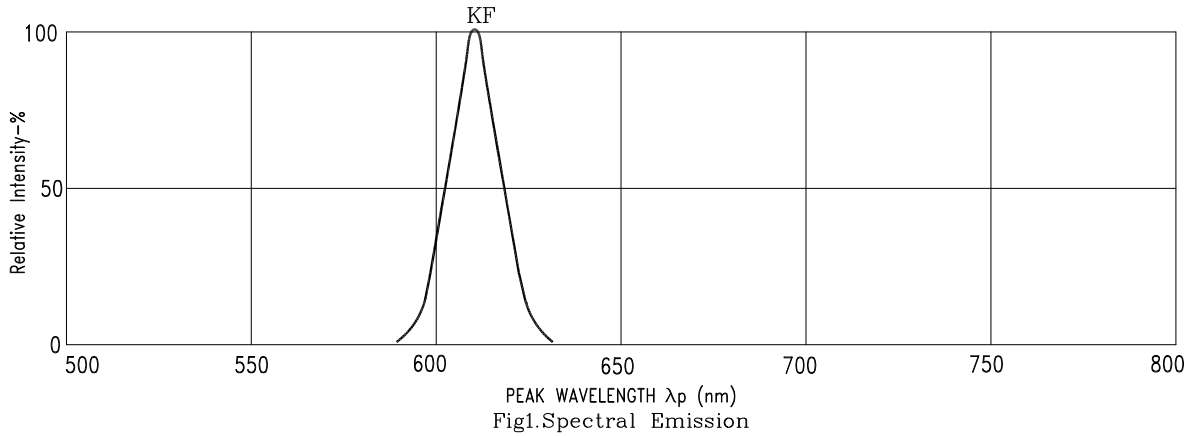

NOTE : KF=AlInGaP YELLOW ORANGE