



LED Display Product Data Sheet LTC-5623SW-14

Spec No.: DS30-2011-0133

Effective Date: 08/03/2011

Revision: -

LITE-ON DCC

RELEASE

BNS-OD-FC001/A4

LED DISPLAY**LTC-5623SW-14**
DATA SHEET

<u>Item</u>	<u>Description</u>	<u>By</u>	<u>DATE</u>
1	New Spec	Eason Lin	2011/02/22
2	Change surface color to black face.	Eason Lin	2011/05/14
3	Change pin length.	Eason Lin	2011/05/17
3	Correct forward current derating curve.	Eason Lin	2011/05/18

FEATURES

- * 0.56 inch (14.2 mm) DIGIT HEIGHT.
- * CONTINUOUS UNIFORM SEGMENTS.
- * LOW POWER REQUIREMENT.
- * EXCELLENT CHARACTERS APPEARANCE.
- * HIGH BRIGHTNESS & HIGH CONTRAST.
- * WIDE VIEWING ANGLE.
- * SOLID STATE RELIABILITY.
- * CATEGORIZED FOR LUMINOUS INTENSITY.

DESCRIPTION

The LTC-5623SW-14 is a 0.56 inch (14.2 mm) digit height quadruple digit seven-segment display. This device utilizes InGaN White LED chips (InGaN on a transparent substrate). The device has a black face and white segment.

DEVICE

PART NO.	DESCRIPTION
InGaN White	Multiplex Common Anode
LTC-5623SW-14	Rt. Hand Decimal

PACKAGE DIMENSIONS

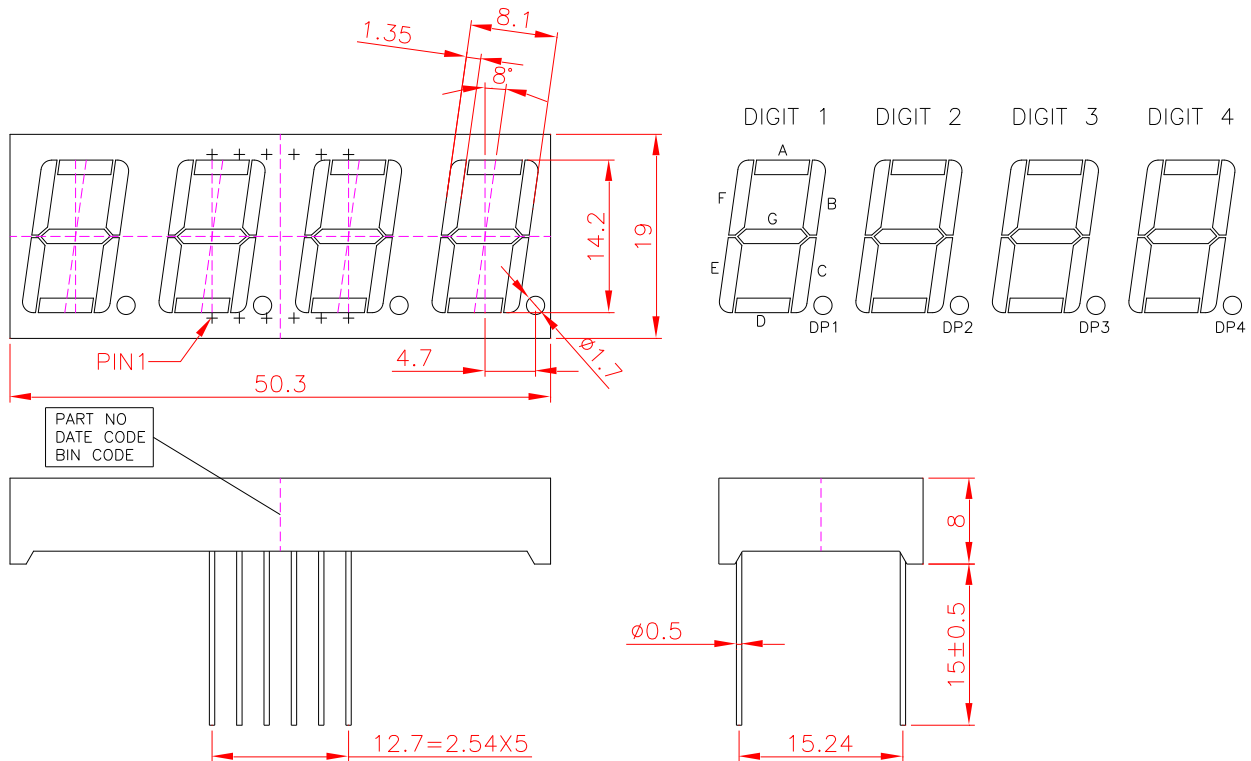

NOTES:

1. All dimensions are in millimeters. Tolerances are ± 0.25 mm (0.01") unless otherwise noted.
2. Pin tip's shift tolerance is ± 0.4 mm. Tolerance of pin length is ± 0.5 mm.

INTERNAL CIRCUIT DIAGRAM

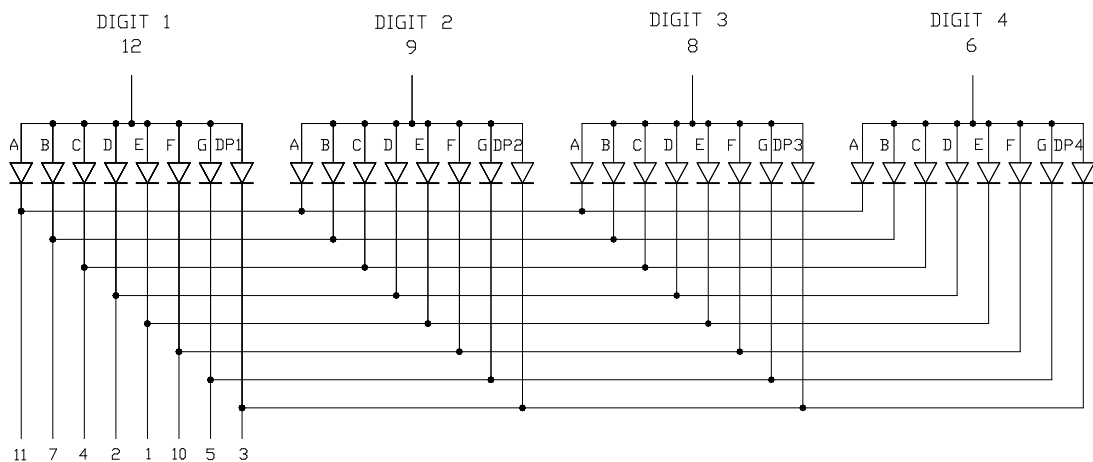

PIN CONNECTION

No.	CONNECTION
1	CATHODE E
2	CATHODE D
3	CATHODE D.P.
4	CATHODE C
5	CATHODE G
6	COMMON ANODE DIGIT 4
7	CATHODE B
8	COMMON ANODE DIGIT 3
9	COMMON ANODE DIGIT 2
10	CATHODE F
11	CATHODE A
12	COMMON ANODE DIGIT 1

CHIP LED ABSOLUTE MAXIMUM RATING AT Ta=25°C

PARAMETER	MAXIMUM RATING	UNIT
Power Dissipation Per Segment	70	mW
Peak Forward Current Per Segment (1/10 Duty Cycle, 0.1ms Pulse Width)	100	mA
Continuous Forward Current Per Segment	20	mA
Operating Temperature Range	-35 °C to +85 °C	
Storage Temperature Range	-35 °C to +85 °C	
Solder Temperature: max 260 °C for max 5sec at 1.6mm below seating plane.		

CHIP LED ELECTRICAL / OPTICAL CHARACTERISTICS AT Ta=25°C

PARAMETER	SYMBOL	MIN.	TYP.	MAX.	UNIT	TEST CONDITION
Luminous Intensity per Segment	Iv	54		112	mcd	IF=5mA Note 1, 2, 5
Viewing Angle per Segment	2θ 1/2		130		Deg	Fig. 6
Chromaticity Coordinates	x		0.294		nm	IF=5mA Note 3, 5 Fig. 1
	y		0.286		nm	
Forward Voltage Per Segment	VF	2.7		3.15	V	IF=5mA
Reverse Current Per Segment ⁽⁵⁾	IR			100	μA	VR=5V
Luminous Intensity Matching Ratio (Similar Light Area)	Iv-m			2:1		IF=1mA

Note:

- Luminous intensity is measured with a light sensor and filter combination that approximates the CIE (Commision Internationale De L'Eclairage) eye-response curve.
- Iv classification code is marked on each packing bag.
- The chromaticity coordinates (x, y) is derived from the 1931 CIE chromaticity diagram.
- Caution in ESD:
Static Electricity and surge damages the LED. It is recommended using a wrist band or anti-electrostatic glove when handling the LED. All devices, equipment and machinery must properly grounded.
- Reverse voltage is only for IR test. It can not continue to operate at this situation.

TYPICAL ELECTRICAL / OPTICAL CHARACTERISTIC CURVES

(25°C Ambient Temperature Unless Otherwise Noted)

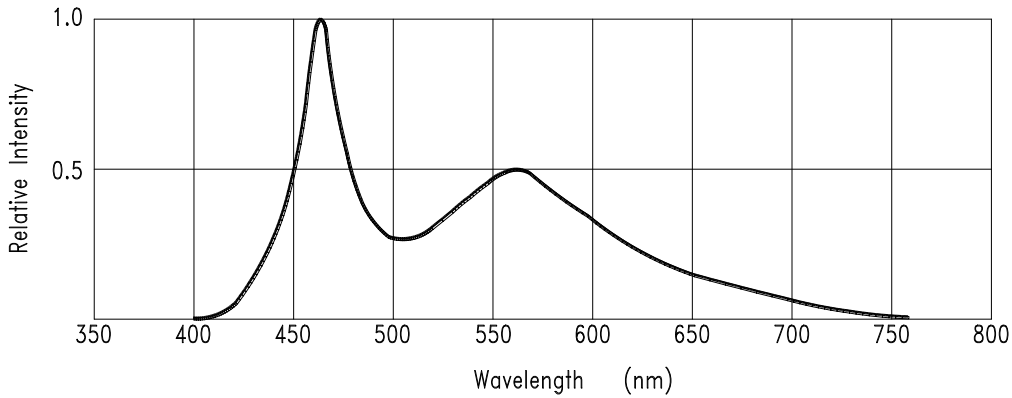

Fig.1 RELATIVE INTENSITY VS. WAVELENGTH

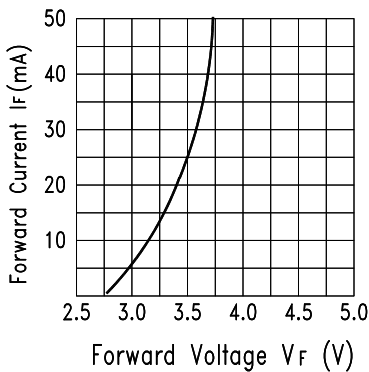

Fig.2 Forward Current vs. Forward Voltage

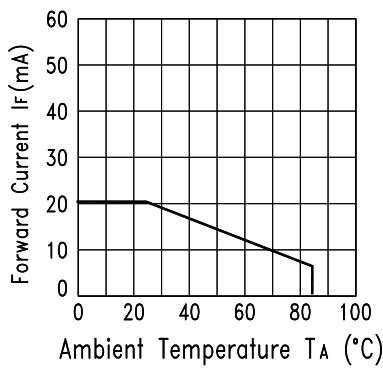

Fig.3 Forward Current Derating Curve

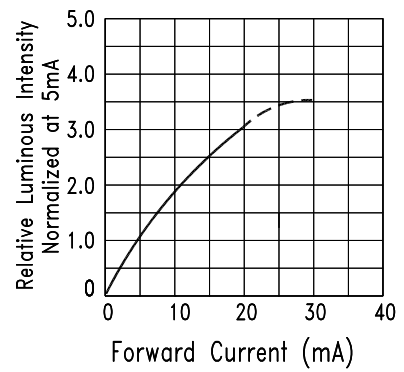

Fig.4 Relative Luminous Intensity vs. Forward Current

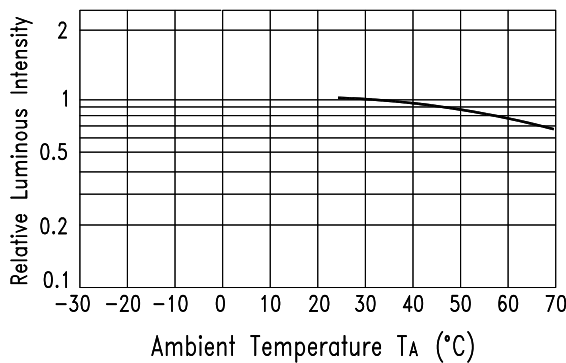

Fig.5 Luminous Intensity vs. Ambient Temperature

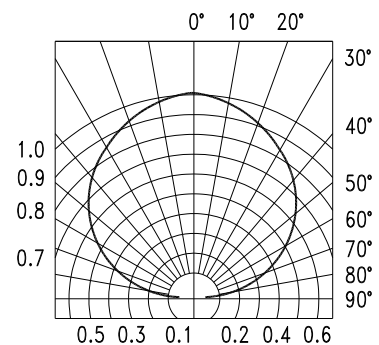

Fig.6 Spatial Distribution