



## **SMD LED**

# Product Data Sheet

## LTPL-C0673WPYB

Spec No.: DS35-2015-0005

Effective Date: 02/06/2015

Revision: -

**LITE-ON DCC**

**RELEASE**

**BNS-OD-FC001/A4**

## SMD LED LTPL-C0673WPYB

### 1. Description

LITEON FLASH is a compact power LED light source specifically designed to provide greater amounts of light where needed, enabling higher resolution pictures to be taken in lower level ambient light environments at greater distances..

#### 1.1 Features

- Highest brightness SMD Flash LED
- Instant Turn On. Very small emitter size
- RoHS Compliant

#### 1.2 Applications

- Camera phones
- Handhelds
- Digital still cameras

### 2. Package Dimensions

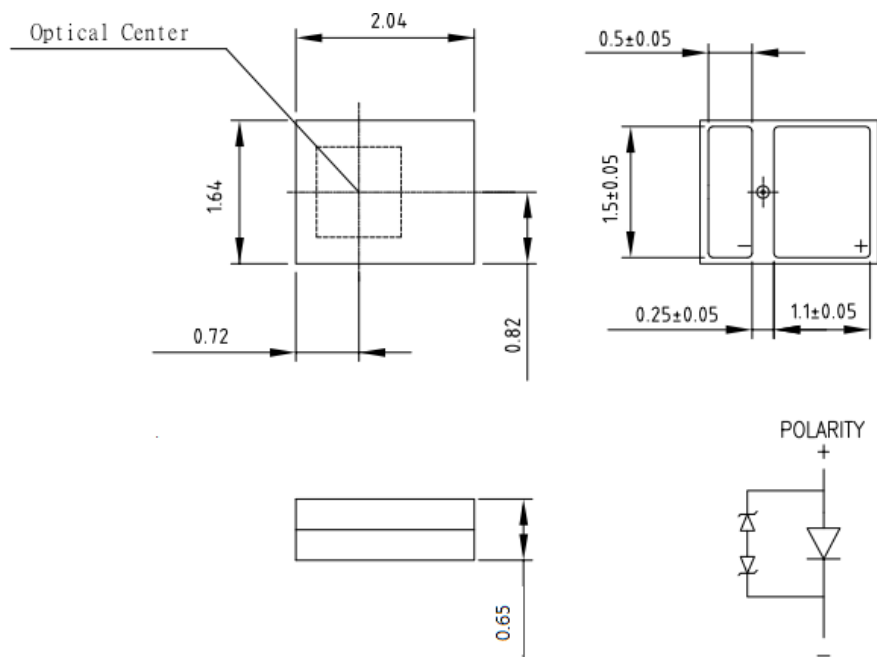

Part No.	Lens Color	Emitted Color
LTPL-C0673WPYB	Yellow/White	InGaN White

#### Notes :

1. All dimensions are in millimeters and dimension tolerances are  $\pm 0.1$ mm.
2. Dimensions without tolerances are for reference only.

## SMD LED LTPL-C0673WPYB

### 3. Rating and Characteristics

#### 3.1 Absolute Maximum Ratings at Ta=25°C

Parameter	LTPL-C0673WPYB	Unit
Power Dissipation(Pulse Mode)	6.75	W
Pulsed Forward Current (33ms:ON · 1617ms: OFF · D=0.02)	1500	mA
DC Forward Current	350	mA
Junction Temperature	125	°C
Electrostatic Discharge Threshold (HBM)	8000	V
Operating Temperature Range	-40 °C to + 85 °C	
Storage Temperature Range	-40 °C to + 100 °C	

**Notes :**

1. HBM : Human Body Model.
2. Stresses in excess of the absolute maximum ratings can cause damage to the emitter. Maximum Rating limits apply to each parameter in isolation, all parameters having values within the Current Derating Curves. It should not be assumed that limiting values of more than one parameters can be applied to the product at the same time. Exposures to the absolute maximum ratings for extended periods can adversely affect device reliability and continuously will cause possible permanent damage and de-rating parameters.

## SMD LED LTPL-C0673WPYB

### 3.2 Suggest IR Reflow Condition For Pb Free Process:

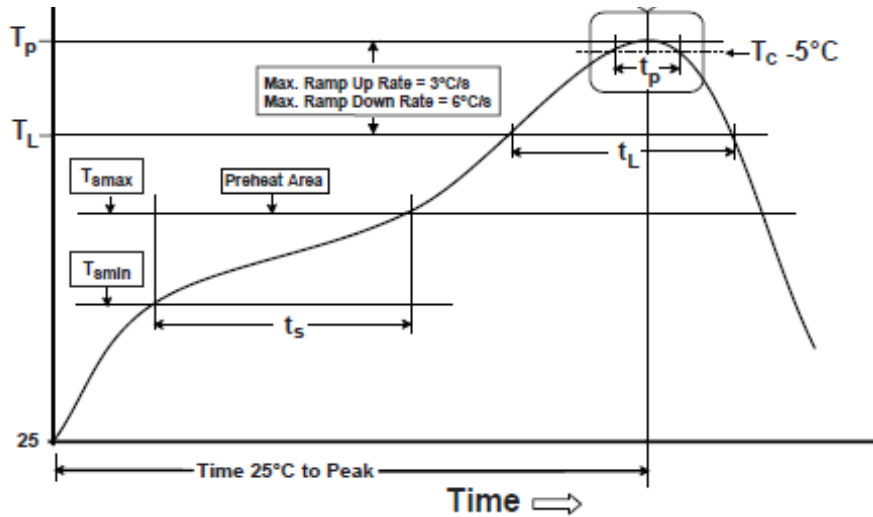

Profile Feature	Lead Free Assembly
Average Ramp-Up Rate ( $T_{Smax}$ to $T_P$ )	3°C / second max
Preheat Temperature Min ( $T_{Smin}$ )	150°C
Preheat Temperature Max ( $T_{Smax}$ )	200°C
Preheat Time ( $t_{Smin}$ to $t_{Smax}$ )	60 – 120 seconds
Time Maintained Above Temperature ( $T_L$ )	217°C
Time Maintained Above Time ( $t_L$ )	60 – 150 seconds
Peak / Classification Temperature ( $T_P$ )	260°C
Time Within 5°C of Actual Peak Temperature ( $t_p$ )	5 seconds
Ramp – Down Rate	6°C / second max
Time 25°C to Peak Temperature	8 minutes max

#### Notes:

1. All temperatures refer to topside of the package, measured on the package body surface.
2. The soldering condition referring to J-STD-020D.
3. The soldering profile could be further referred to different soldering grease material characteristic. The grease vendor will provide this information.
4. A rapid-rate process is not recommended for the LEDs cooling down from the peak temperature.
5. Although the recommended reflow conditions are specified above, the reflow or hand soldering condition at the lowest possible temperature is desirable for the LEDs.
6. LiteOn cannot make a guarantee on the LEDs which have been already assembled using the dip soldering method.

## SMD LED LTPL-C0673WPYB

### 3.3 Electrical / Optical Characteristics at Ta=25°C

Parameter	Symbol	LTPL-C0673WPYB			Unit	Test Condition
		MIN.	TYP.	MAX.		
Luminous Flux	$\Phi_V$	160	200	315	lm	$I_{FP} = 1000\text{mA}$
Viewing Angle	$2\theta_{1/2}$	--	120	--	Deg	Fig.2
Color Temperature	CCT	4500	--	7000	K	$I_{FP} = 1000\text{mA}$
Forward Voltage	VF	3.0	3.6	4.5	V	$I_{FP} = 1000\text{mA}$
Reverse Current	IR	--	--	100	$\mu\text{A}$	VR = 5V Note 4

**NOTE:**

1. Luminous flux measurement tolerance:  $\pm 10\%$
2. Forward voltage measurement tolerance:  $\pm 0.1\text{V}$
3. Electric and optical data is tested at 300ms pulse condition.
4. Reverse voltage(VR) condition is applied to IR test only. The device is not designed for reverse operation.

## SMD LED LTPL-C0673WPYB

### 4. Bin Rank

#### 4.1 Bin code list

##### ■ Luminous Flux Binning

Parameter	Bin	Symbol	Min	Typ.	Max	Unit	Condition
Luminous Flux	M1	ΦV	160	--	180	lm	I <sub>FP</sub> = 1000mA
	M2		180	--	200		
	N0		200	--	250		
	P0		250	--	315		

Luminous flux measurement tolerance: ±10%

##### ■ Forward Voltage Binning

Parameter	Bin	Symbol	Min	Typ.	Max	Unit	Condition
Forward Voltage	R	VF	3.0	--	3.3	V	I <sub>FP</sub> = 1000mA
	S		3.3	--	3.6		
	T		3.6	--	3.9		
	W		3.9	--	4.2		
	X		4.2	--	4.5		

Forward voltage measurement tolerance: ±0.1V

## SMD LED LTPL-C0673WPYB

### Category Code Table

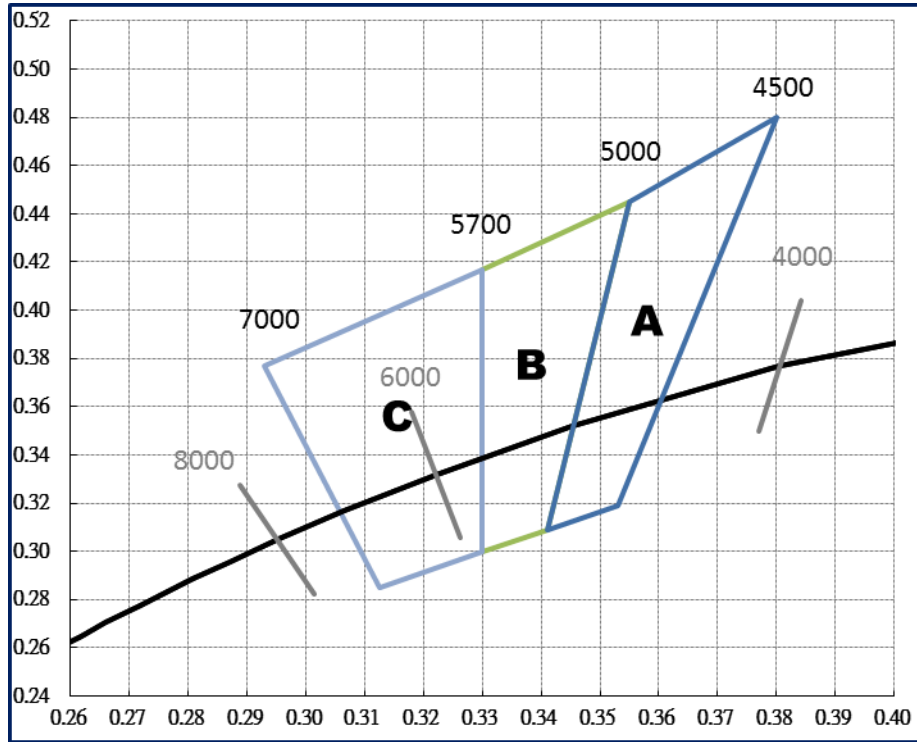

Bin	Cx	Cy	Bin	Cx	Cy	Bin	Cx	Cy
A	0.38	0.48	B	0.355	0.445	C	0.33	0.417
	0.355	0.445		0.33	0.417			
	0.341	0.309		0.33	0.3			
	0.353	0.319		0.341	0.309			
						0.293	0.3771	
						0.3125	0.285	
						0.33	0.3	

**Notes:**

1. The value is all dies operated performance.
2. The chromaticity coordinates (x, y) is derived from the CIE 1931 chromaticity diagram.
3. IS CAS140B is for the luminous flux (lm) and the CIE1931 chromaticity coordinates (x, y) testing. The chromaticity coordinates (x, y) guarantee should be added  $\pm 0.01$  tolerance.

# SMD LED LTPL-C0673WPYB

## 5. Typical Electrical / Optical Characteristics Curves.

(25°C Ambient Temperature Unless Otherwise Noted)

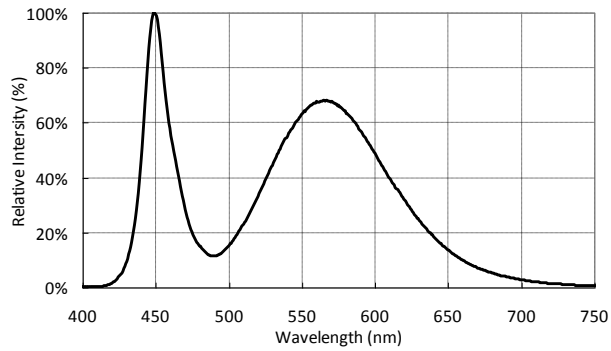

Fig 1. Relative Spectrum of Emission

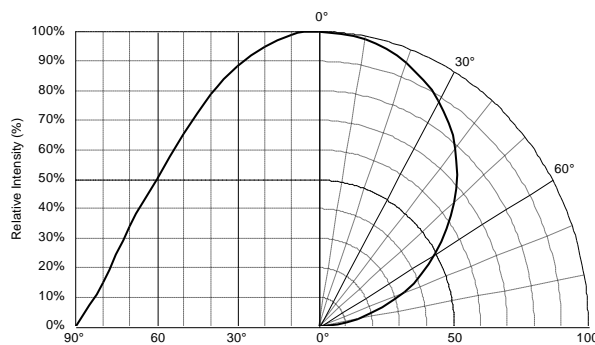

Fig 2. Radiation Characteristics

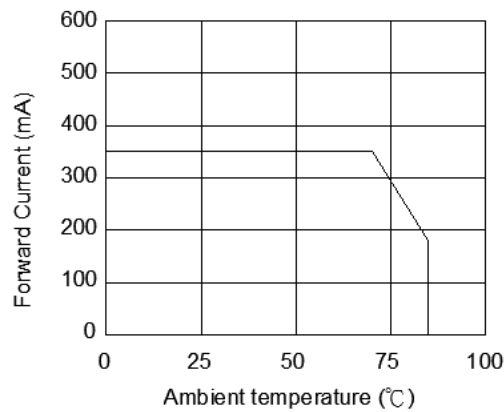

Fig 3. Forward Current Derating Curve



## SMD LED LTPL-C0673WPYB

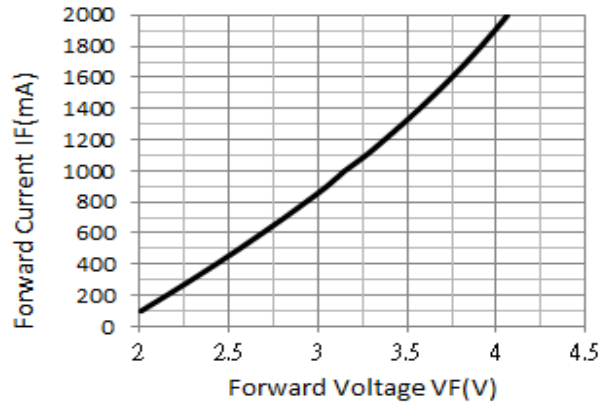

Fig 4. Forward Current

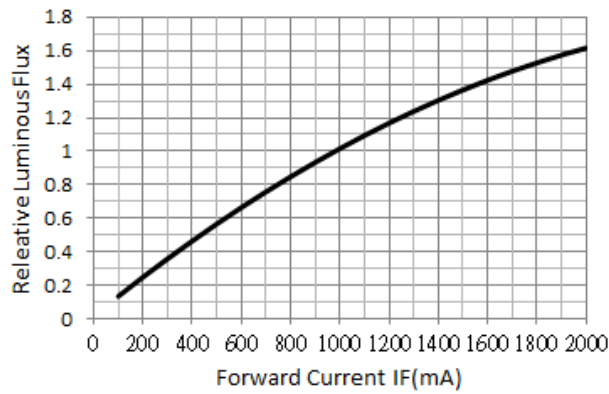

Fig 5. Relative Luminous Flux

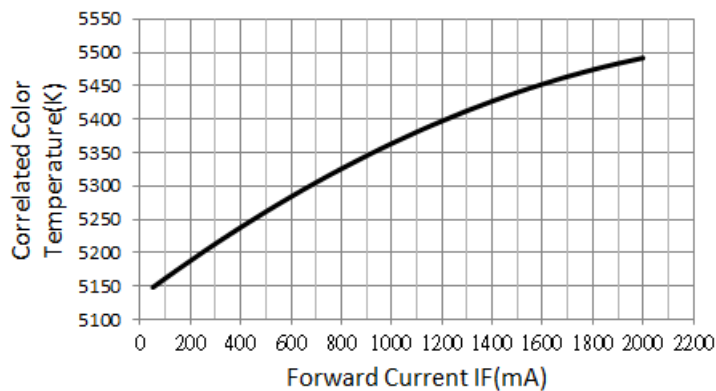

Fig 6. Correlated Color Temperature (CCT) Shift

**Notes:** All correlation data is mounted on thermal heat sink with 2cmX 2cm Metal Core PCB

## SMD LED LTPL-C0673WPYB

### 6. User Guide

#### 6.1 Cleaning

Do not use unspecified chemical liquid to clean LED they could harm the package.

If clean is necessary, immerse the LED in ethyl alcohol or in isopropyl alcohol at normal temperature for less one minute.

#### 6.2 Recommend Printed Circuit Board Attachment Pad

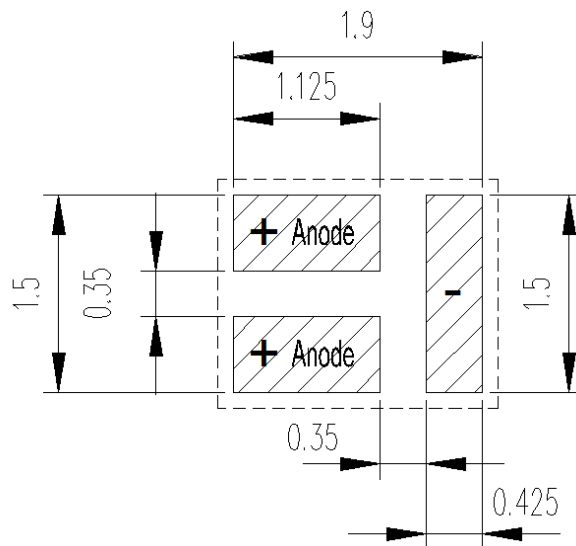

#### Notes:

1. Suggest stencil thickness is maximum 0.10mm.

## SMD LED LTPL-C0673WPYB

### 6.3 Package Dimensions Of Tape And Reel

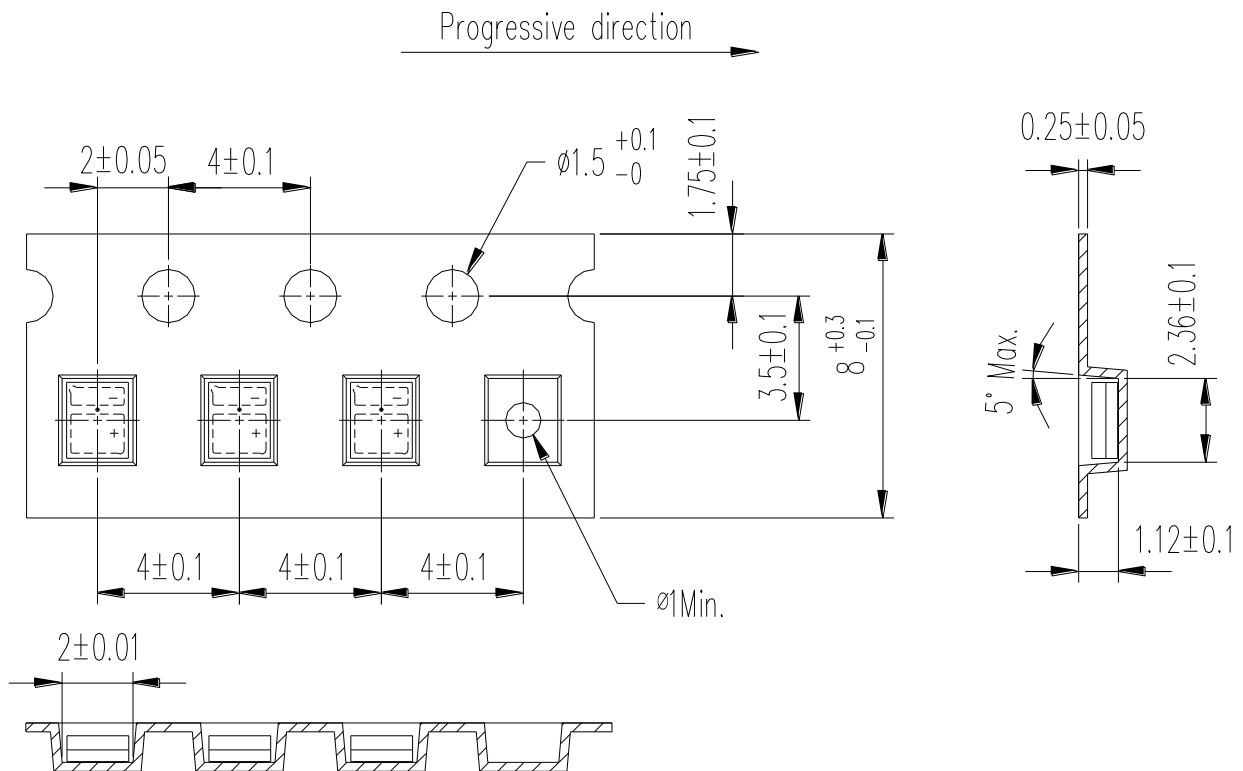

**Note:**

1. Drawings not to scale.
2. All dimensions are in millimeters.
3. All dimensions without tolerances are for reference only.

## SMD LED LTPL-C0673WPYB

### 6.4 Package Dimensions of Reel

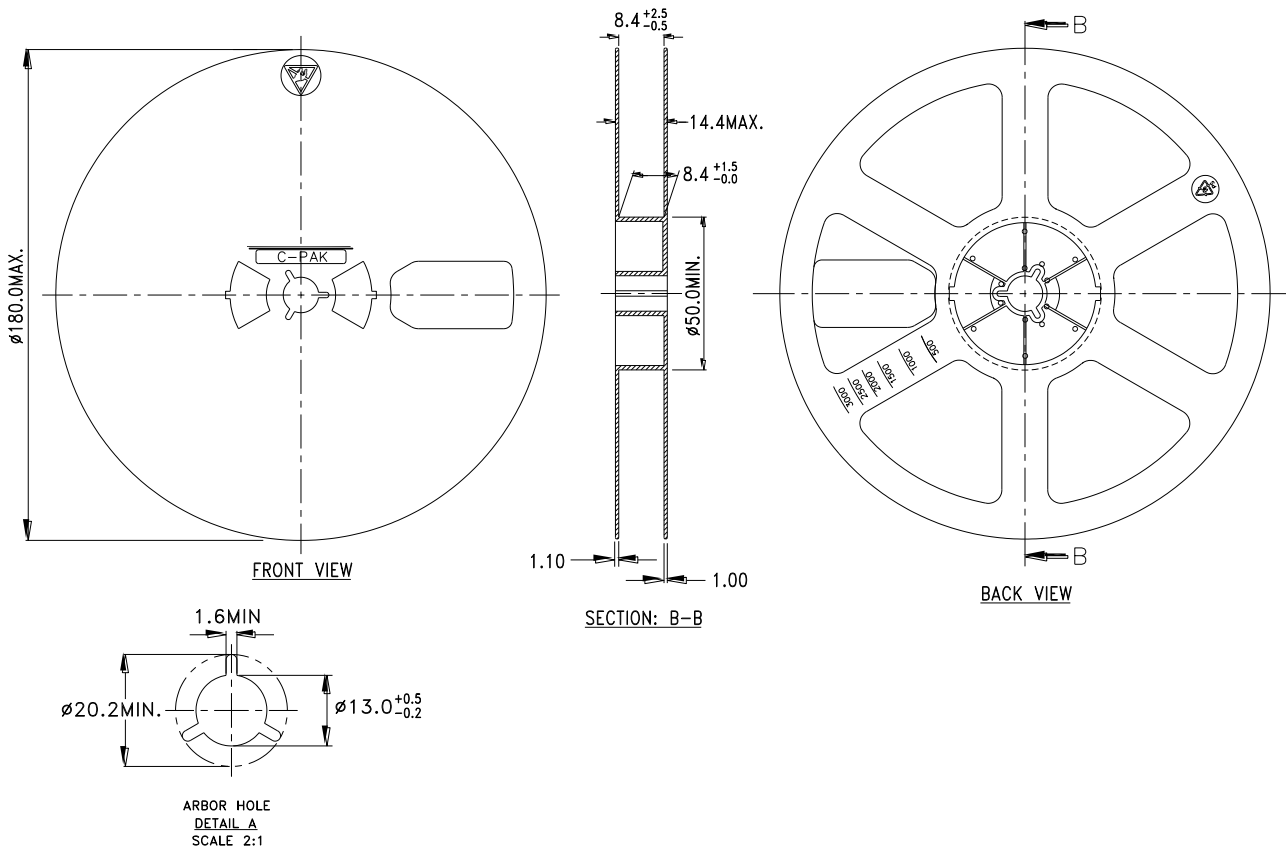

#### Notes:

1. Drawings not to scale.
2. All dimensions are in millimeters.
3. All dimensions without tolerances are for reference only.
4. Minimum package quantity is 500 pieces for remainders.
5. 7 inch reel-2000 pieces.
6. Empty component pockets sealed with top cover tape.
7. The maximum number of consecutive missing lamps is two
8. In accordance with EIA-481 specifications

# SMD LED LTPL-C0673WPYB

## 7. Cautions

### 7.1 Application

The LEDs described here are intended to be used for ordinary electronic equipment (such as office equipment, communication equipment and household applications). Consult Liteon's Sales in advance for information on applications in which exceptional reliability is required, particularly when the failure or malfunction of the LEDs may directly jeopardize life or health (such as in aviation, transportation, traffic control equipment, medical and life support systems and safety devices).

### 7.2 Storage

This product is qualified as Moisture sensitive Level 3 per JEDEC J-STD-020 Precaution when handling this moisture sensitive product is important to ensure the reliability of the product.

The package is sealed:

The LEDs should be stored at 30°C or less and 90%RH or less. And the LEDs are limited to use within one year, while the LEDs is packed in moisture-proof package with the desiccants inside.

The package is opened:

The LEDs should be stored at 30°C or less and 60%RH or less. Moreover, the LEDs are limited to solder process within 168hrs. If the Humidity Indicator shows the pink color in 10% even higher or exceed the storage limiting time since opened, that we recommended to baking LEDs at 60°C at least 48hrs. To seal the remainder LEDs return to package, it's recommended to be with workable desiccants in original package.

### 7.3 Cleaning

Use alcohol-based cleaning solvents such as isopropyl alcohol to clean the LED if necessary.

### 7.4 Soldering

Recommended soldering conditions:

Reflow soldering		Soldering iron	
Pre-heat	150~200°C	Temperature	300°C Max.
Pre-heat time	120 sec. Max.	Soldering time	3 sec. Max.
Peak temperature	260°C Max.		(one time only)
Soldering time	10 sec. Max.(Max. two times)		

Notes:

Because different board designs use different number and types of devices, solder pastes, reflow ovens, and circuit boards, no single temperature profile works for all possible combinations. However, you can successfully mount your packages to the PCB WA following the proper guidelines and PCB-specific characterization.

LITE-ON Runs both component-level verification using in-house **KYRAMX98** reflow chambers and board-level assembly. The results of this testing are verified through post-reflow reliability testing. Profiles used at LITE-ON are based on JEDEC standards to ensure that all packages can be successfully and reliably surface mounted. Figure on page2 shows a sample temperature profile compliant to JEDEC standards. You can use this example as a generic target to set up your reflow process. You should adhere to the JEDEC profile limits as well as specifications and recommendations from the solder paste manufacturer to avoid damaging the device and create a reliable solder joint.

## SMD LED LTPL-C0673WPYB

### 7.5 Drive Method

A LED is a current-operated device. In order to ensure intensity uniformity on multiple LEDs connected in parallel in an application, it is recommended that a current limiting resistor be incorporated in the drive circuit, in series with each LED as shown in Circuit A below.

**Circuit model A**

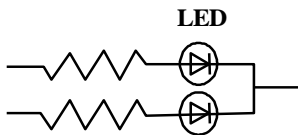

**Circuit model B**

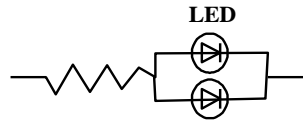

(A) Recommended circuit.

(B) The brightness of each LED might appear different due to the differences in the I-V characteristics of those LEDs.

### 7.6 ESD (Electrostatic Discharge)

Static Electricity or power surge will damage the LED.

Suggestions to prevent ESD damage:

- Use of a conductive wrist band or anti-electrostatic glove when handling these LEDs.
- All devices, equipment, and machinery must be properly grounded.
- Work tables, storage racks, etc. should be properly grounded.
- Use ion blower to neutralize the static charge which might have built up on surface of the LED's plastic lens as a result of friction between LEDs during storage and handling.

Plastic lens as a result of friction between LEDs during storage and handling.

ESD-damaged LEDs will exhibit abnormal characteristics such as high reverse leakage current, low forward Voltage, or "no light-up" at low currents.

To verify for ESD damage, check for "light up" and  $V_f$  of the suspect LEDs at low currents.

The  $V_f$  of "good" LEDs should be  $>2.0V @ 0.1mA$  for InGaN product. forward voltage, or "no lightup" at low currents.

To verify for ESD damage, check for "lightup" and  $V_f$  of the suspect LEDs at low currents.

## SMD LED LTPL-C0673WPYB

### 8. Reliability Test

Stress Test	Stress Condition	Stress Duration
Thermal Cycling	- 40°C (30min)/100°C (30min) transition time 5 min@25°C	500 cycles
Thermal Shock	- 40°C (20min)/100°C (20min) transition time 20 secs	200 cycles
Room Temperature Operation Life	25°C, IF=350mA	168hr
Low Temperature Storage Life	- 40°C	168hr
High Temperature Storage Life	100°C	168hr
Resistance to solder heat	T <sub>sol</sub> =260°C, 10sec,6min	3 times
Wet High Temperature Operation Life	85°C/85%	168hr
Pulse test	I <sub>F</sub> =1000mA 50ms on /950 ms off @25°C	30000times

**Notes:**

1. All reliability items are mounted on thermal heat sink with 2cmX 2cm Metal Core PCB

## SMD LED LTPL-C0673WPYB

### 9. Others

The appearance and specifications of the product may be modified for improvement without prior notice.

### 10. Suggested Checking List

#### Training and Certification

1. Everyone working in a static-safe area is ESD-certified?
2. Training records kept and re-certification dates monitored?

#### Static-Safe Workstation & Work Areas

1. Static-safe workstation or work-areas have ESD signs?
2. All surfaces and objects at all static-safe workstation and within 1 ft measure less than 100V?
3. All ionizer activated, positioned towards the units?
4. Each work surface mats grounding is good?

#### Personnel Grounding

1. Every person (including visitors) handling ESD sensitive (ESDS) items wears wrist strap, heel strap or conductive shoes with conductive flooring?
2. If conductive footwear used, conductive flooring also present where operator stand or walk?
3. Garments, hairs or anything closer than 1 ft to ESD items measure less than 100V\*?
4. Every wrist strap or heel strap/conductive shoes checked daily and result recorded for all DLs?
5. All wrist strap or heel strap checkers calibration up to date?

Note: \*50V for InGaN LED.

#### Device Handling

1. Every ESDS items identified WA EIA-471 labels on item or packaging?
2. All ESDS items completely inside properly closed static-shielding containers when not at static-safe workstation?
3. No static charge generators (e.g. plastics) inside shielding containers with ESDS items?
4. All flexible conductive and dissipative package materials inspected before reuse or recycles?

#### Others

1. Audit result reported to entity ESD control coordinator?
2. Corrective action from previous audits completed?
3. Are audit records complete and on file?