



SMD LED
Product Data Sheet
LTST-008TGVSWT

Spec No. :DS35-2019-0114
Effective Date: 11/02/2019
Revision: -

LITE-ON DCC

RELEASE

BNS-OD-FC001/A4

SMD LED LTST-008TGVSWT

1. Description

SMD LEDs from Lite-On are available in miniature sizes and special configurations for automated PC board assembly and space-sensitive applications. These SMD LEDs are suitable for use in a wide variety of electronic equipment, including cordless and cellular phones, notebook computers, network systems, home appliances, and indoor signboard applications.

1.1 Features

- Meet ROHS
- Package in 12mm tape on 7" diameter reels
- EIA STD package
- I.C. compatible
- Compatible with automatic placement equipment
- Compatible with infrared reflow solder process
- Preconditioning: accelerate to JEDEC level 3

1.2 Applications

- Telecommunication, Office automation, home appliances, industrial equipment
- Signage
- Indoor display

2. Package Dimensions

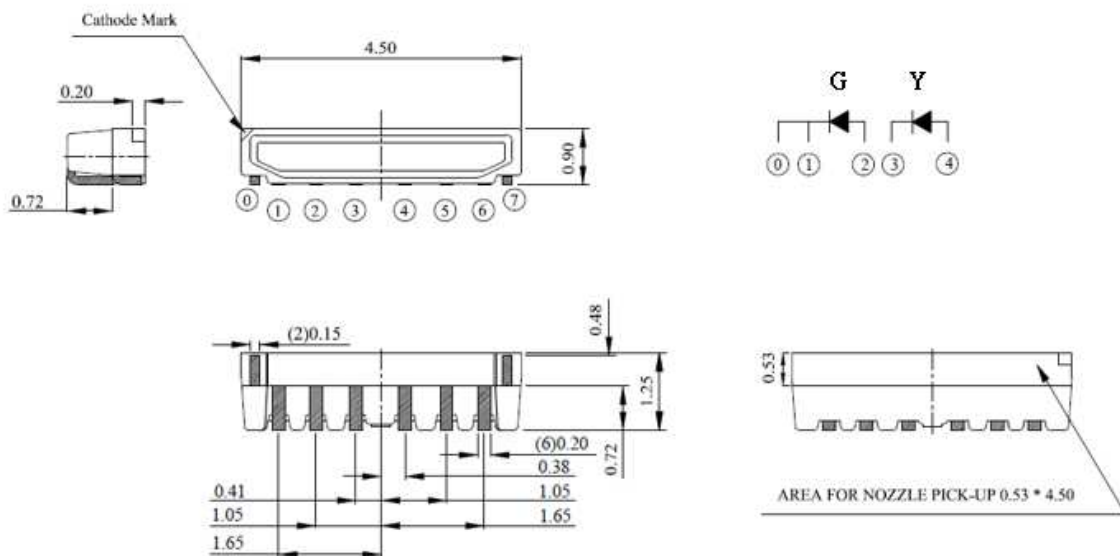

Part No.	Lens Color	Source Color	Pin Assignment
LTST-008TGVSWT	White Diffused	InGaN Green	(0,1) , 2
		AllInGaP Yellow	3, 4
		null	5, 6, 7

Notes:

1. All dimensions are in millimeters.
2. Tolerance is ± 0.1 mm (.004") unless otherwise noted.

**SMD LED
LTST-008TGVSWT**

3. Rating and Characteristics

3.1 Absolute Maximum Ratings at Ta=25°C

Parameter	LTST-008TGVSWT		Unit
	Green	Yellow	
Power Dissipation	102	125	mW
Peak Forward Current (1/10 Duty Cycle, 0.1ms Pulse Width)	80	100	mA
DC Forward Current	30	50	mA
Operating Temperature Range	-40°C to + 85°C		
Storage Temperature Range	-40°C to + 100°C		

3.2 Suggest IR Reflow Condition for Pb Free Process:

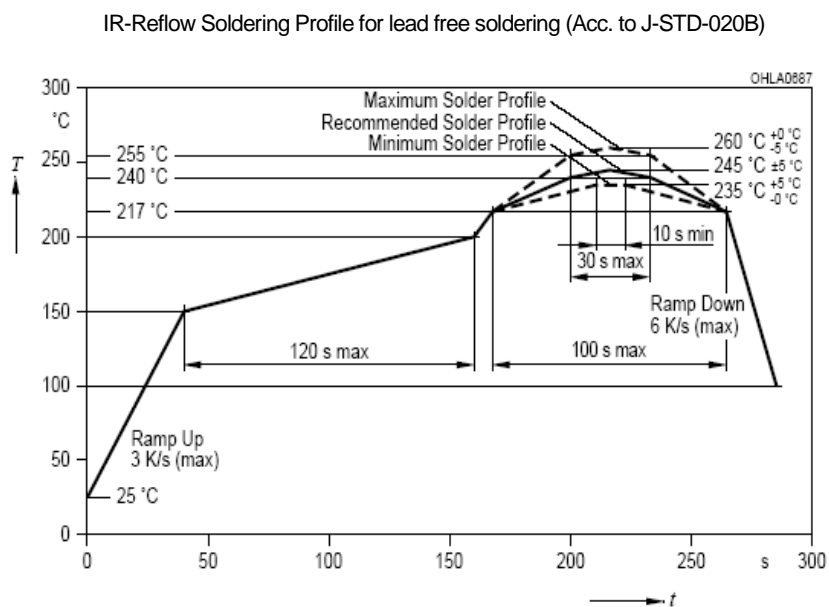

SMD LED LTST-008TGVSWT

3.3 Electrical / Optical Characteristics at Ta=25°C

Parameter	Symbol		LTST-008TGVSWT		Unit	Test Condition
			Green	Yellow		
Luminous Intensity	Φ_v	MIN.	2.05	2.05	lm	G: I _F = 10mA Y: I _F = 20mA Note 1
		TYP.	-	-		
		MAX.	5.50	5.50		
Luminous Intensity	IV	MIN.	750	750	mcd	G: I _F = 10mA Y: I _F = 20mA Note 2
		TYP.	-	-		
		MAX.	2000	2000		
Viewing Angle	2 $\theta_{1/2}$	TYP.	130			Note 3 (Fig.5)
Peak Emission Wavelength	λ_P	TYP.	521	591	nm	Measurement @Peak (Fig.1)
Dominant Wavelength	λ_d	MIN.	525	585	nm	G: I _F = 10mA Y: I _F = 20mA Note 4
		MAX.	535	595		
Spectral Line Half-Width	$\Delta\lambda$	TYP.	35	15	nm	G: I _F = 10mA Y: I _F = 20mA
Forward Voltage	VF	MIN.	2.5	1.8	V	G: I _F = 10mA Y: I _F = 20mA Note 5
		TYP.	-	-		
		MAX.	3.4	2.5		
Reverse Current	IR	MAX.	10	10	μ A	VR = 5V Note 6

Notes:

- Luminous intensity is measured with a light sensor and filter combination that approximates the CIE eye-response curve
- Luminous Intensity (mcd) is for reference.
- $\theta_{1/2}$ is the off-axis angle at which the luminous intensity is half the axial luminous intensity.
- The dominant wavelength, λ_d is derived from the CIE chromaticity diagram and represents the single wavelength which defines the color of the device
- Forward Voltage Tolerance is +/- 0.1 volt.
- Reverse voltage (VR) condition is applied to IR test only. The device is not designed for reverse operation.

SMD LED LTST-008TGVSWT

4. Bin Rank

4.1.1 IV Rank

Luminous Intensity Color : <u>Green</u> @ 10mA				
Bin Code	Luminous Flux (lm)		Luminous Intensity (mcd)	
	Min.	Max.	Min.	Max.
G1	2.05	2.84	750	1040
G2	2.84	3.95	1040	1450
G3	3.95	5.50	1450	2000

Tolerance on each Luminous bin is +/- 11%, and Luminous Intensity(mcd) is for reference.

Luminous Intensity Color : <u>Yellow</u> @ 20mA				
Bin Code	Luminous Flux (lm)		Luminous Intensity (mcd)	
	Min.	Max.	Min.	Max.
Y1	2.05	2.84	750	1040
Y2	2.84	3.95	1040	1450
Y3	3.95	5.50	1450	2000

Tolerance on each Luminous bin is +/- 11%, and Luminous Intensity(mcd) is for reference.

4.1.2 IV Bin Code on Tag Cross Table

Luminous Intensity Unit : lm, Green@10mA, Yellow@20mA				
Bin Code	Green		Yellow	
	On Tag	Code	Range	Code
A1	G1	2.05-2.84	Y1	2.05-2.84
A2			Y2	2.84-3.95
A3			Y3	3.95-5.50
A4	G2	2.84-3.95	Y1	2.05-2.84
A5			Y2	2.84-3.95
A6			Y3	3.95-5.50
A7	G3	3.95-5.50	Y1	2.05-2.84
A8			Y2	2.84-3.95
A9			Y3	3.95-5.50

Tolerance on each Intensity bin is +/-11%

**SMD LED
LTST-008TGVSWT**

4.2.1 WD Rank

Dominant Wavelength Color : <u>Green</u> , Unit: nm @ 10mA		
Bin Code	Min.	Max.
AQ	525	530
AR	530	535

Tolerance for each Dominate Wavelength bin is +/- 1nm.

Dominant Wavelength Color : <u>Yellow</u> , Unit: nm @ 20mA		
Bin Code	Min.	Max.
AU	585	590
AV	590	595

Tolerance for each Dominate Wavelength bin is +/- 1nm.

4.2.2 WD Bin Code on Tag Cross Table

Dominant Wavelength		Unit : nm, Green@10mA, Yellow@20mA		
Bin Code On Tag	Green		Yellow	
	Code	Range	Code	Range
D1	AQ	525-530	AU	585-590
D2			AV	590-595
D3	AR	530-535	AU	585-590
D4			AV	590-595

Tolerance on each Intensity bin is +/-11%

5. Typical Electrical / Optical Characteristics Curves.

(25°C Ambient Temperature Unless Otherwise Noted)

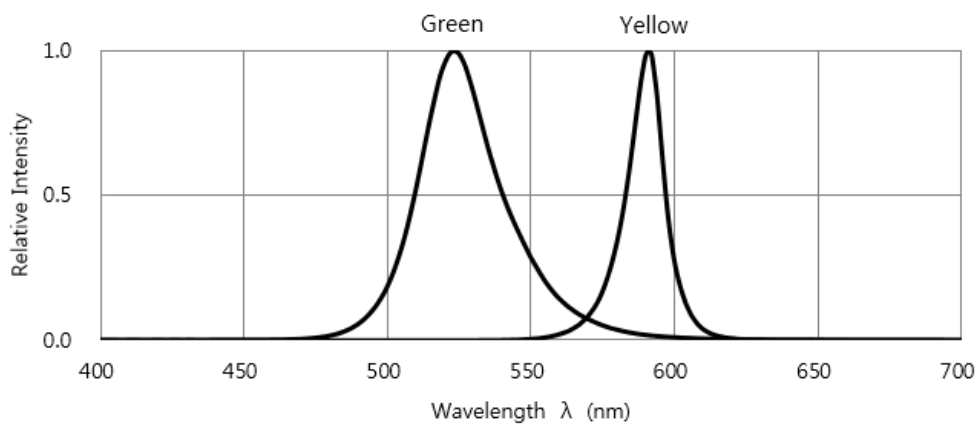

Fig. 1 RELATIVE INTENSITY VS. WAVELENGTH

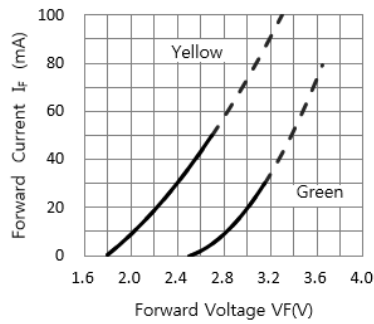

Fig. 2 FORWARD CURRENT VS. FORWARD VOLTAGE

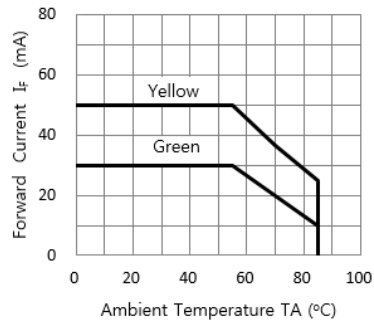

Fig. 3 FORWARD CURRENT VS. DERATING CURVE

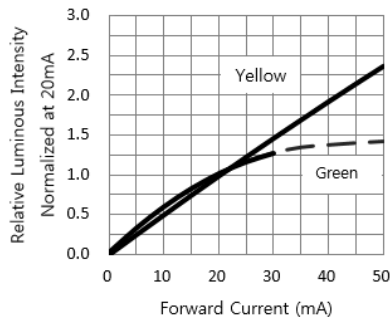

Fig. 4 RELATIVE LUMINOUS INTENSITY VS. FORWARD CURRENT

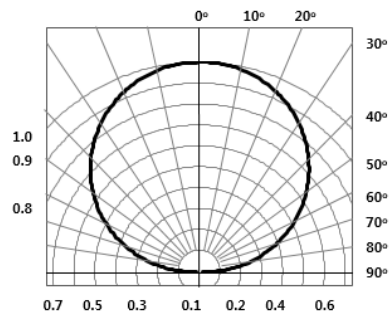

Fig. 5 Spatial Distribution

**SMD LED
LTST-008TGVSWT**

6. User Guide

6.1 Cleaning

Do not use unspecified chemical liquid to clean LED they could harm the package. If cleaning is necessary, immerse the LED in ethyl alcohol or isopropyl alcohol at normal temperature for less one minute.

6.2 Recommend Printed Circuit Board Attachment Pad

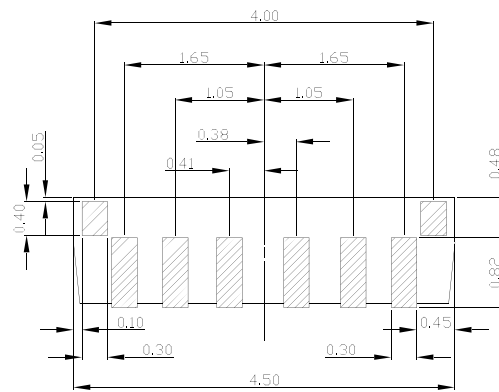

6.3 Package Dimensions of Tape and Reel

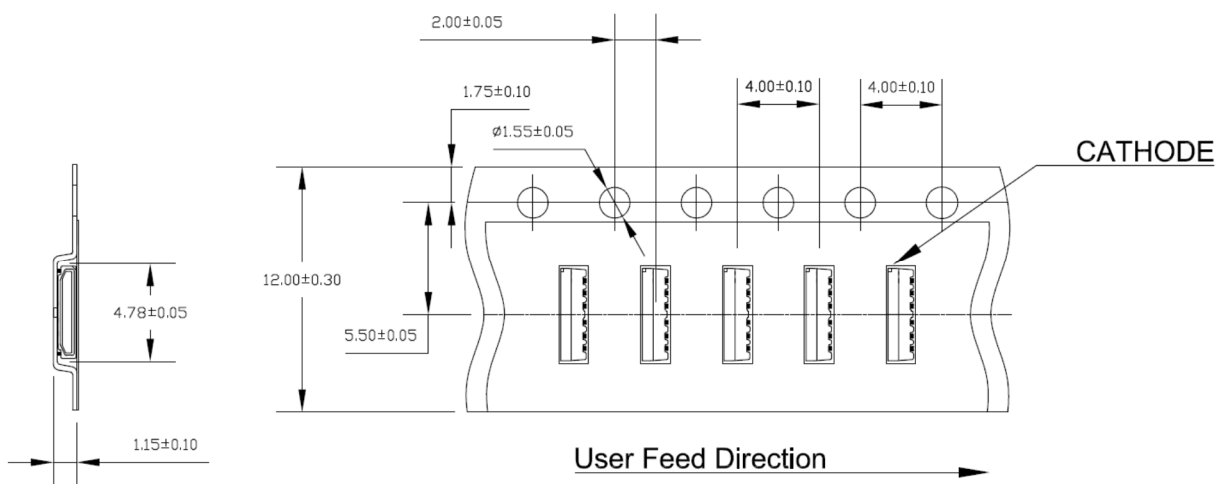

Note:

1. All dimensions are in millimeters (inches).

SMD LED LTST-008TGVSWT

6.4 Package Dimensions of Reel

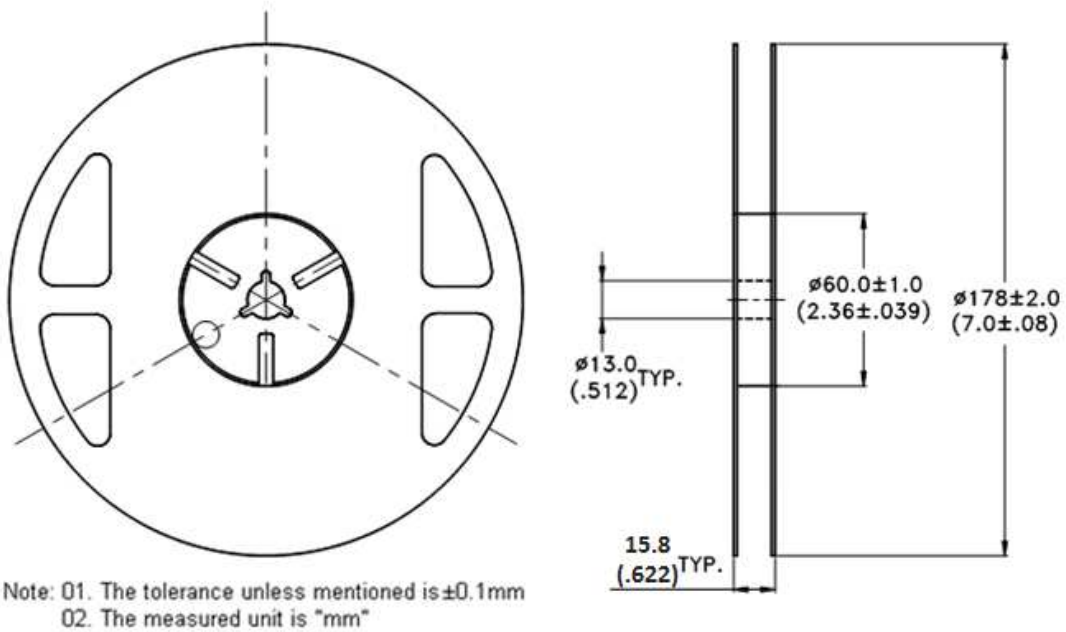

Notes:

1. Empty component pockets sealed with top cover tape.
2. 7 inch reel 3000 pieces per reel.
3. Minimum packing quantity is 500 pieces for remainders.
4. The maximum number of consecutive missing lamps is two.
5. In accordance with ANSI/EIA 481 specifications.

**SMD LED
LTST-008TGVSWT**

7. Cautions

7.1 Application

The LEDs described here are intended to be used for ordinary electronic equipment (such as office equipment, communication equipment and household applications). Consult Liteon's Sales in advance for information on applications in which exceptional reliability is required, particularly when the failure or malfunction of the LEDs may directly jeopardize life or health (such as in aviation, transportation, traffic control equipment, medical and life support systems and safety devices).

7.2 Storage

The package is sealed:

The LEDs should be stored at 30°C or less and 70%RH or less. And the LEDs are limited to use within one year, while the LEDs is packed in moisture-proof package with the desiccants inside.

The package is opened:

The storage ambient for the LEDs should not exceed 30°C temperature and 60% relative humidity.

It is recommended that LEDs out of their original packaging are IR-reflowed within 168hrs.

For extended storage out of their original packaging, it is recommended that the LEDs be stored in a sealed container with appropriate desiccant, or in a desiccators with nitrogen ambient.

LEDs stored out of their original packaging for more than 168hrs should be baked at about 60 °C for at least 48 hours before solder assembly.

7.3 Cleaning

Use alcohol-based cleaning solvents such as isopropyl alcohol to clean the LED if necessary.

7.4 Soldering

Recommended soldering conditions:

Reflow soldering		Soldering iron	
Pre-heat	150~200°C	Temperature	300°C Max.
Pre-heat time	120 sec. Max.	Soldering time	3 sec. Max. (one time only)
Peak temperature	260°C Max.		
Soldering time	10 sec. Max.(Max. two times)		

Notes:

Because different board designs use different number and types of devices, solder pastes, reflow ovens, and circuit boards, no single temperature profile works for all possible combinations.

However, you can successfully mount your packages to the PCB by following the proper guidelines and PCB-specific characterization.

LITE-ON Runs both component-level verification using in-house **KYRAMX98** reflow chambers and board-level assembly. The results of this testing are verified through post-reflow reliability testing. Profiles used at LITE-ON are based on JEDEC standards to ensure that all packages can be successfully and reliably surface mounted.

Figure on page3 shows a sample temperature profile compliant to JEDEC standards. You can use this example as a generic target to set up your reflow process. You should adhere to the JEDEC profile limits as well as specifications and recommendations from the solder paste manufacturer to avoid damaging the device and create a reliable solder joint.

**SMD LED
LTST-008TGVSWT**

7.5 Drive Method

A LED is a current-operated device. In order to ensure intensity uniformity on multiple LEDs connected in parallel in an application, it is recommended that a current limiting resistor be incorporated in the drive circuit, in series with each LED as shown in Circuit A below.

Circuit model A

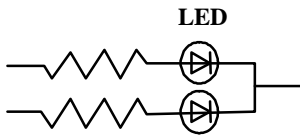

Circuit model B

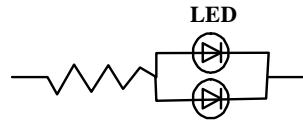

(A) Recommended circuit.

(B) The brightness of each LED might appear different due to the differences in the I-V characteristics of those LEDs.

7.6 ESD (Electrostatic Discharge)

Static Electricity or power surge will damage the LED.

Suggestions to prevent ESD damage:

- Use of a conductive wrist band or anti-electrostatic glove when handling these LEDs.
- All devices, equipment, and machinery must be properly grounded.
- Work tables, storage racks, etc. should be properly grounded.
- Use ion blower to neutralize the static charge which might have built up on surface of the LED's plastic lens as a result of friction between LEDs during storage and handling.

ESD-damaged LEDs will exhibit abnormal characteristics such as high reverse leakage current, low forward voltage, or "no lightup" at low currents.

To verify for ESD damage, check for "lightup" and V_f of the suspect LEDs at low currents.

The V_f of "good" LEDs should be $>2.0V@0.1mA$ for InGaN product and $>1.4V@0.1mA$ for AlInGaP product.

**SMD LED
LTST-008TGVSWT**

8. Reliability Test

No.	Test item	Test condition	Reference standard
1	Resistance to soldering heat	Tsld = 260°C, 10sec. 3 times	JEITA ED-4701 300 301
2	Solderability	Tsld=245± 5°C (Lead Free Solder, Coverage ≥ 95% of the dipped surface)	JEITA ED-4701 300 303
3	Thermal Shock	85 ± 5°C ~ -30°C ± 5°C 30min 30min 100cycles	JEITA ED-4701 300 307
4	Temperature Cycle	-40°C ~ 25°C ~ 100°C ~ 25°C 30min 5min 30min 5min 100cycles	JEITA ED-4701 100 105
5	High Temperature Storage	100°C 1000hrs	JEITA ED-4701 200 201
6	Low Temperature Storage	-40°C 1000hrs	JEITA ED-4701 200 202
7	Temperature Humidity Storage	60°C/90%RH 1000hrs	JEITA ED-4701 100 103
8	Room temp life test	1. 25°C, IF: Max current ,500hrs 2. 25°C, IF: Typical current,1000hrs	--
9	High temp life test	85°C, IF: For derating curve 1000hrs	--
10	Low temp life test	-30°C, IF: Typical current 1000hrs	JEITA ED-4701 200 202
11	High Temp./Humidity life test (WHTOL)	60°C 90%RH IF: For derating curve 1000hrs	--

9. Others

The appearance and specifications of the product may be modified for improvement without prior notice.

SMD LED LTST-008TGVSWT

10. Suggested Checking List

Training and Certification

1. Everyone working in a static-safe area is ESD-certified?
2. Training records kept and re-certification dates monitored?

Static-Safe Workstation & Work Areas

1. Static-safe workstation or work-areas have ESD signs?
2. All surfaces and objects at all static-safe workstation and within 1 ft measure less than 100V?
3. All ionizer activated, positioned towards the units?
4. Each work surface mats grounding is good?

Personnel Grounding

1. Every person (including visitors) handling ESD sensitive (ESDS) items wears wrist strap, heel strap or conductive shoes with conductive flooring?
2. If conductive footwear used, conductive flooring also present where operator stand or walk?
3. Garments, hairs or anything closer than 1 ft to ESD items measure less than 100V*?
4. Every wrist strap or heel strap/conductive shoes checked daily and result recorded for all DLs?
5. All wrist strap or heel strap checkers calibration up to date?

Note: *50V for InGaN LED.

Device Handling

1. Every ESDS items identified by EIA-471 labels on item or packaging?
2. All ESDS items completely inside properly closed static-shielding containers when not at static-safe workstation?
3. No static charge generators (e.g. plastics) inside shielding containers with ESDS items?
4. All flexible conductive and dissipative package materials inspected before reuse or recycles?

Others

1. Audit result reported to entity ESD control coordinator?
2. Corrective action from previous audits completed?
3. Are audit records complete and on file?