



SMD LED
Product Data Sheet
LTST-E183CEGBW-TO

Spec No. :DS35-2021-0045
Effective Date: 06/05/2021
Revision: -

LITE-ON DCC

RELEASE

BNS-OD-FC001/A4

SMD LED LTST-E183CEGBW-TO

1. Description

SMD LEDs from Lite-On are available in miniature sizes and special configurations for automated PC board assembly and space-sensitive applications. These SMD LEDs are suitable for use in a wide variety of electronic equipment, including cordless and cellular phones, notebook computers, network systems, home appliances, and indoor signboard applications.

1.1 Features

- ROHS Compliant. Halogen & Pb free.
- Packaged in 8mm tape on 7" diameter reels
- EIA STD package
- Compatible with automatic placement equipment
- Compatible with infrared reflow solder process
- Preconditioning: accelerate to JEDEC level 4
- Control circuit and RGB chip are integrated in the package, form a complete control of pixel point
- Each of the three primary color can achieve 256 brightness steps, to form 16,777,216 combination colors
- 8-bit driver IC embedded. Constant current PWM control
- Cascading port transmission signal by single line

1.2 Applications

- Telecommunication, office automation, industrial equipment
- Status indicator
- Signal and symbol luminary
- Front panel backlighting
- Full-color module, full color soft lights a lamp strip
- LED decorative lighting, indoor LED video irregular displays

2. Package Dimensions / Configuration

2.1 Package Dimensions

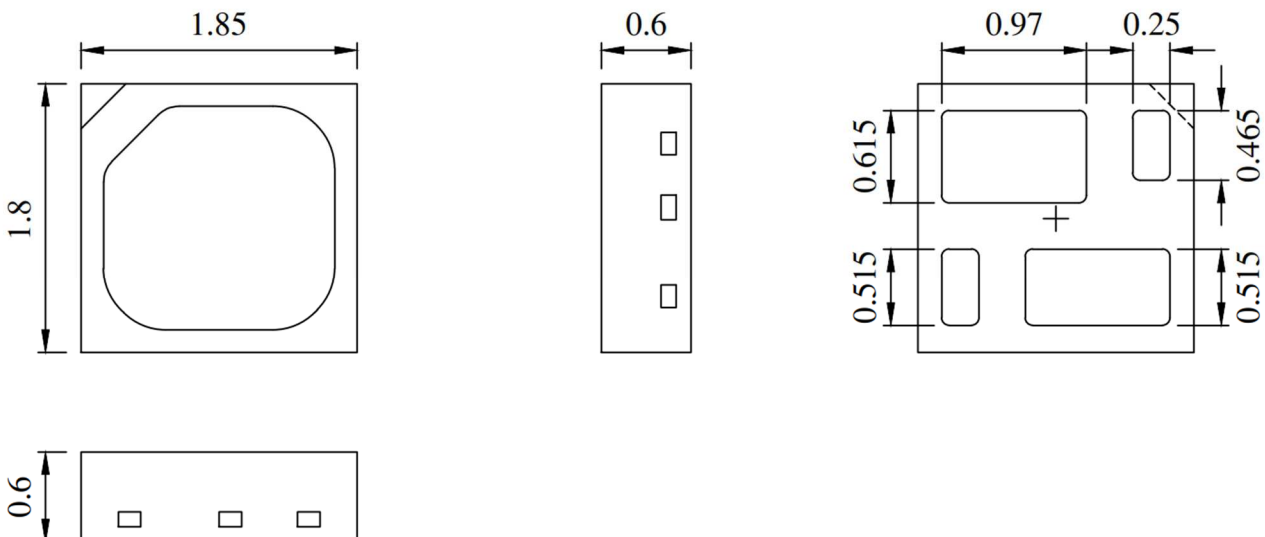

Notes:

1. All dimensions are in millimeters.
2. Tolerance is ± 0.2 mm unless otherwise noted.

SMD LED LTST-E183CEGBW-TO

Part No.	Lens Color	Source Color
LTST-E183CEGBW-TO	White Diffused	AllInGaP Red
		InGaN Green
		InGaN Blue

2.2 PIN Configuration

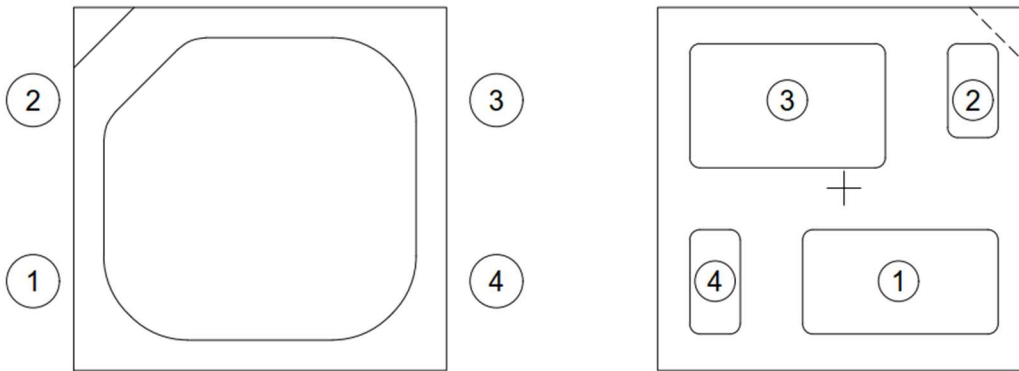

No.	Symbol	Function description
1	VDD	DC power input
2	DIN	Control data signal input
3	VSS	Ground
4	DOUT	Control data signal output

3.2 Suggest IR Reflow Condition for Pb Free Process:

IR-Reflow Soldering Profile for lead free soldering (Acc. to J-STD-020B)

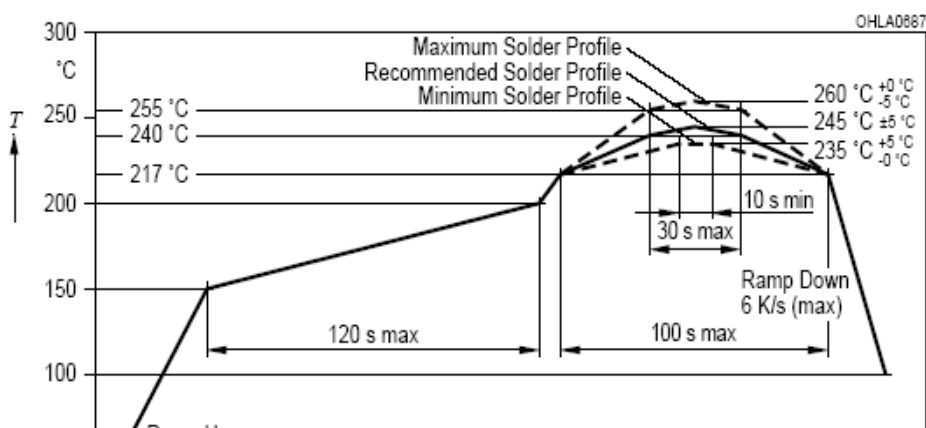

Part No.:
LTST-E183CEGBW-TO
MS-OD-FC002/A4

**SMD LED
LTST-E183CEGBW-TO**

3. Rating and Characteristics

3.1 Absolute Maximum Ratings at Ta=25°C

Parameter	LTST-E183CEGBW-TO		Unit
	Symbol	Ratings	
Power Dissipation	P	99	mW
Supply Voltage Range	VDD	+4.2 ~ +5.5	V
Total DC Current	IF	18	mA
Operating Temperature Range	-40°C to + 85°C		
Storage Temperature Range	-55°C to + 100°C		

SMD LED LTST-E183CEGBW-TO

3.3 Optical Characteristics (Ta=25°C)

Parameter	Symbol	color	LTST-E183CEGBW-TO			Unit	Test Condition
			MIN	TYP.	MAX		
Luminous Intensity	IV	Red	100	-	200	mcd	VDD=5V Note 1
		Green	250	-	500		
		Blue	50	-	120		
Viewing Angle	2θ _{1/2}	-	120			deg	Note 2 (Fig.3)
Dominant Wavelength	λ _d	Red	615	-	630	nm	VDD=5V Note 3
		Green	520	-	535		
		Blue	460	-	475		

Notes:

1. Luminous intensity is measured with a light sensor and filter combination that approximates the CIE eye-response curve.
2. θ_{1/2} is the off-axis angle at which the luminous intensity is half the axial luminous intensity.
3. The dominant wavelength, λ_d is derived from the CIE chromaticity diagram and represents the single wavelength which defines the color of the device. Peak Emission Wavelength Tolerance is +/- 1nm.

3.4 Electrical Characteristics (Ta=-20~+70°C, V_{DD}=3.3~5.5V, V_{SS}=0V, unless otherwise specified)

Parameter	Symbol	Condition	LTST-E183CEGBW-TO			Unit
			MIN	TYP.	MAX	
IC Output Current (to R/G/B separately)	IF	VDD=5V	-	5	-	mA
Input Voltage Level	V _{IH}	D _{IN} , SET	2.7	-	V _{DD}	V
	V _{IL}	D _{IN} , SET	0	-	1.0	V
IC Working Current	IDD	ALL '0' DATA	-	0.8	-	mA

**SMD LED
LTST-E183CEGBW-TO**

3.5 Data transfer time (TH+TL=1.2µs±300ns)

- Timing Wave Form

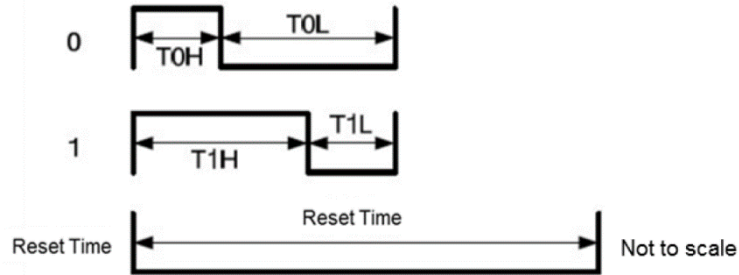

Item	Description	Typical	Allowance
T _{0H}	0 code, high voltage time	300 ns	± 150ns
T _{0L}	0 code, low voltage time	900 ns	± 150ns
T _{1H}	1 code, high voltage time	900 ns	± 150ns
T _{1L}	1 code, low voltage time	300 ns	± 150ns
RES	reset time	>250 µs	-

**SMD LED
LTST-E183CEGBW-TO**

4. CIE Specification

Color Bin Table						Test @ VDD=5V					
Bin Code	Color Bin Limits					Bin Code	Color Bin Limits				
	CIE-	Point1	Point2	Point3	Point4		CIE-	Point1	Point2	Point3	Point4
A	x	0.2500	0.2700	0.2700	0.2500	C	x	0.2700	0.2900	0.2900	0.2700
	y	0.2580	0.2640	0.2840	0.2780		y	0.2640	0.2700	0.2900	0.2840
B	x	0.2500	0.2700	0.2700	0.2500	D	x	0.2700	0.2900	0.2900	0.2700
	y	0.2780	0.2840	0.3040	0.2980		y	0.2840	0.2900	0.3100	0.3040

Tolerance on each CIE (x, y) bin is +/- 0.01

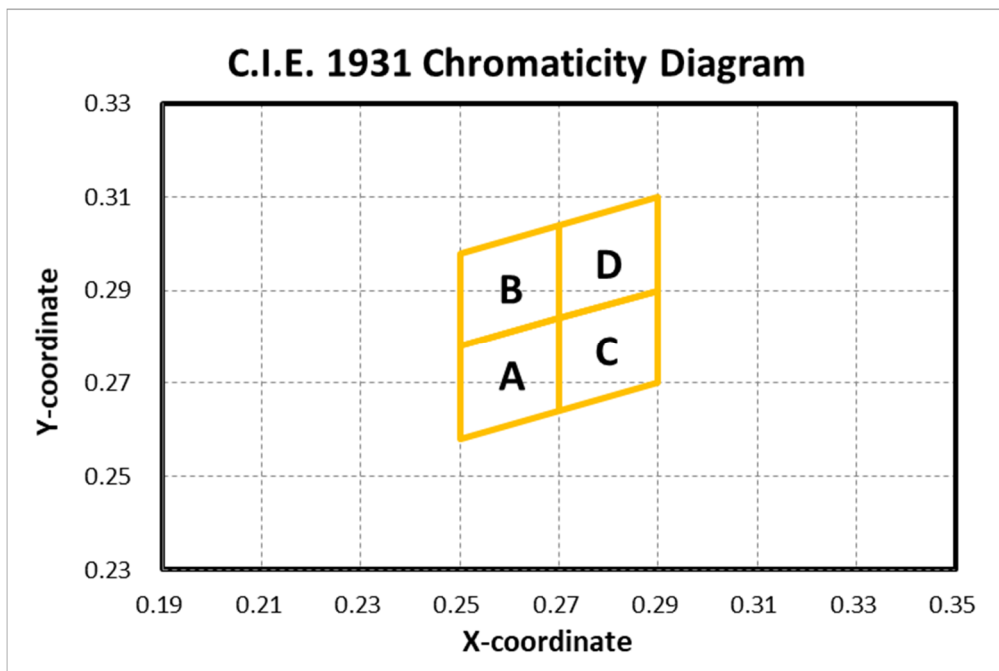

**SMD LED
LTST-E183CEGBW-TO**

5. Typical Electrical / Optical Characteristics Curves.

(25°C Ambient Temperature Unless Otherwise Noted)

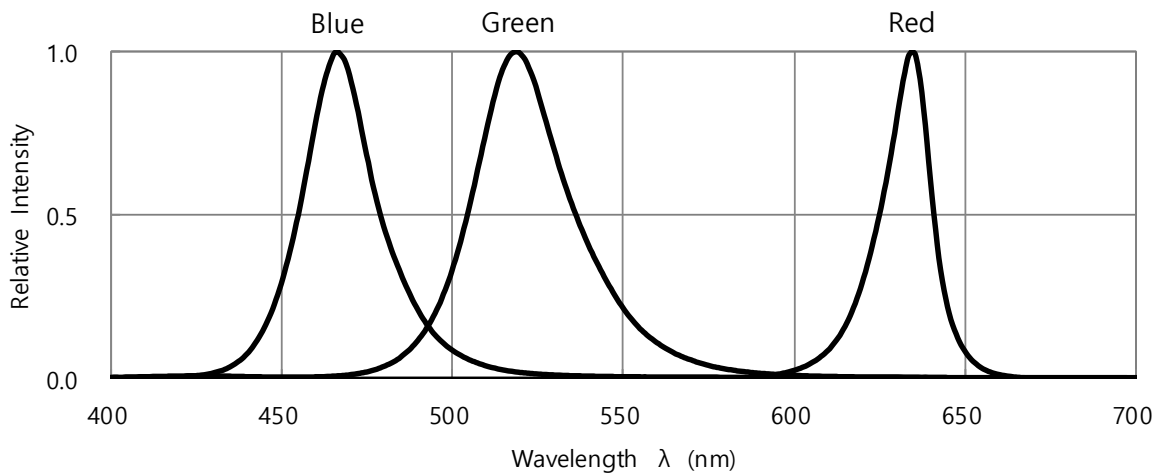

Fig. 1 RELATIVE INTENSITY VS. WAVELENGTH

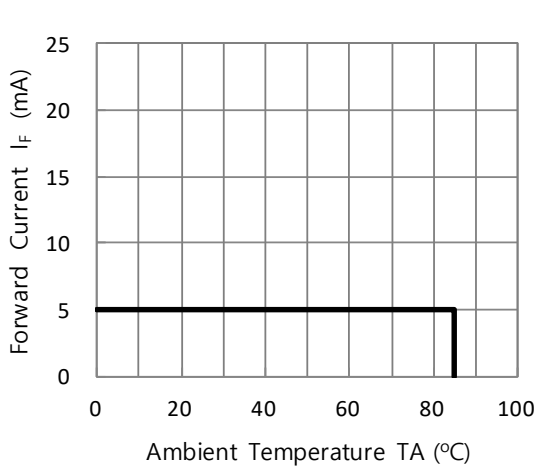

Fig. 2 FORWARD CURRENT VS. DERATING CURVE

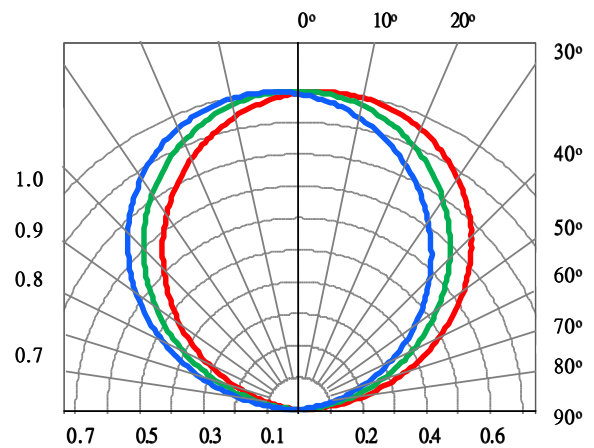

Fig. 3 Spatial Distribution

SMD LED LTST-E183CEGBW-TO

6. User Guide

6.1 Cleaning

Do not use unspecified chemical liquid to clean LED they could harm the package. If cleaning is necessary, immerse the LED in ethyl alcohol or isopropyl alcohol at normal temperature for less one minute.

6.2 Recommend Printed Circuit Board Attachment Pad

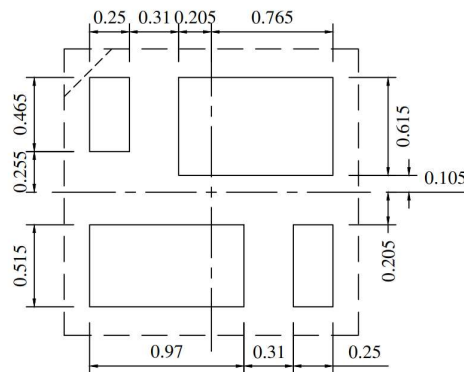

6.3 Package Dimensions of Tape and Reel

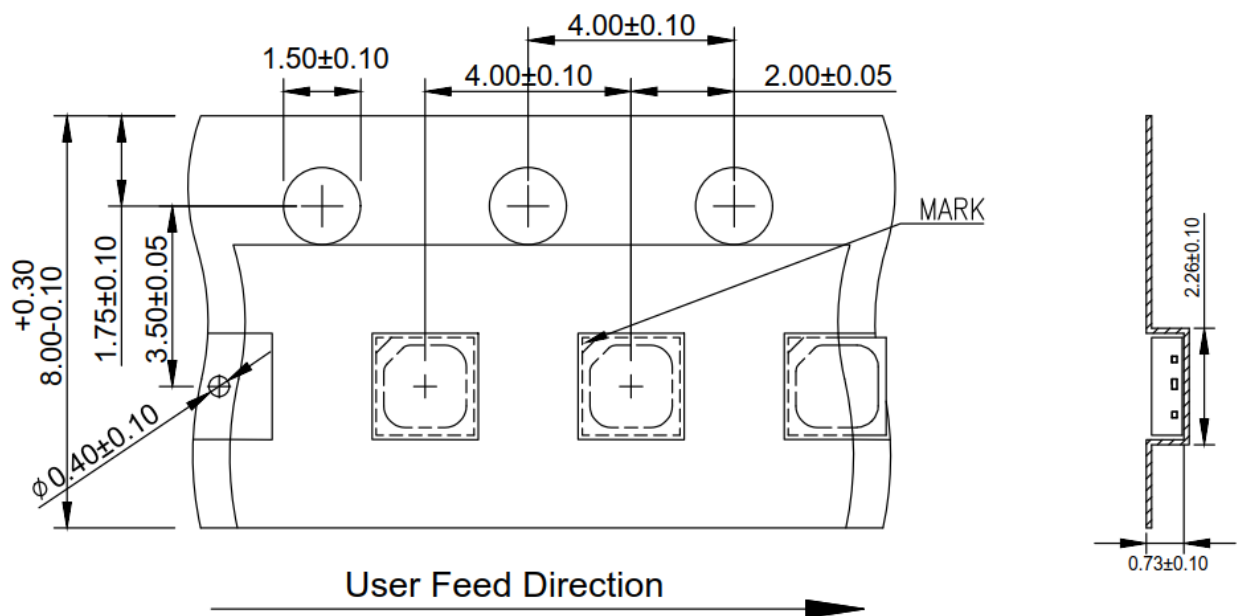

Note:

1. All dimensions are in millimeters (inches).

**SMD LED
LTST-E183CEGBW-TO**

6.4 Package Dimensions of Reel

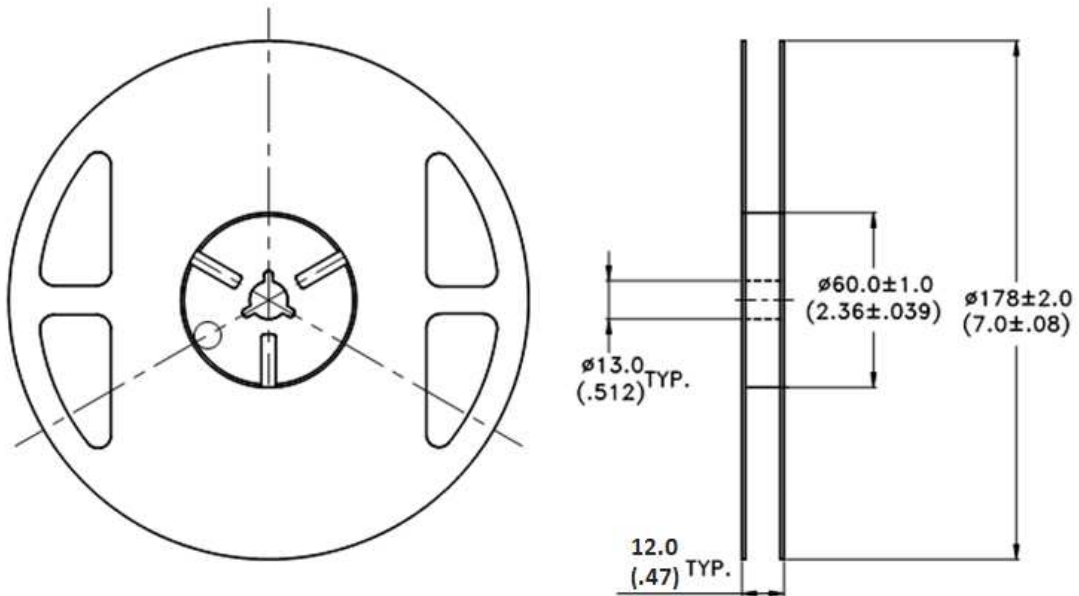

Notes:

1. Empty component pockets sealed with top cover tape.
2. 7 inch reel 4000 pieces per reel.
3. Minimum packing quantity is 500 pieces for remainders.
4. The maximum number of consecutive missing lamps is two.
5. In accordance with ANSI/EIA 481 specifications.

SMD LED LTST-E183CEGBW-TO

7. Cautions

7.1 Application

The LEDs described here are intended to be used for ordinary electronic equipment (such as office equipment, communication equipment and household applications). Consult Liteon's Sales in advance for information on applications in which exceptional reliability is required, particularly when the failure or malfunction of the LEDs may directly jeopardize life or health (such as in aviation, transportation, traffic control equipment, medical and life support systems and safety devices).

7.2 Storage

The package is sealed:

The LEDs should be stored at 30°C or less and 70%RH or less. And the LEDs are limited to use within one year, while the LEDs is packed in moisture-proof package with the desiccants inside.

The package is opened:

The storage ambient for the LEDs should not exceed 30°C temperature and 60% relative humidity.

It is recommended that LEDs out of their original packaging are IR-reflowed within 72hrs.

For extended storage out of their original packaging, it is recommended that the LEDs be stored in a sealed container with appropriate desiccant, or in a desiccator with nitrogen ambient.

LEDs stored out of their original packaging for more than 96hrs should be baked at about 60 °C for at least 48 hours before solder assembly.

7.3 Cleaning

Use alcohol-based cleaning solvents such as isopropyl alcohol to clean the LED if necessary.

7.4 Soldering

Recommended soldering conditions:

Reflow soldering		Soldering iron	
Pre-heat	150~200°C	Temperature	350°C Max.
Pre-heat time	120 sec. Max.	Soldering time	3 sec. Max.
Peak temperature	260°C Max.		(one time only)
Soldering time	10 sec. Max. (Max. two times)		

Notes:

Because different board designs use different number and types of devices, solder pastes, reflow ovens, and circuit boards, no single temperature profile works for all possible combinations.

However, you can successfully mount your packages to the PCB by following the proper guidelines and PCB-specific characterization.

LITE-ON Runs both component-level verification using in-house **KYRAMX98** reflow chambers and board-level assembly.

The results of this testing are verified through post-reflow reliability testing. Profiles used at LITE-ON are based on JEDEC standards to ensure that all packages can be successfully and reliably surface mounted.

Figure on page3 shows a sample temperature profile compliant to JEDEC standards. You can use this example as a generic target to set up your reflow process. You should adhere to the JEDEC profile limits as well as specifications and recommendations from the solder paste manufacturer to avoid damaging the device and create a reliable solder joint.

SMD LED LTST-E183CEGBW-TO

7.5 Driving Method

The LED needs to be incorporated with an appropriate controller to deliver PWM signals to each pixel. Below figure is shown as a reference design.

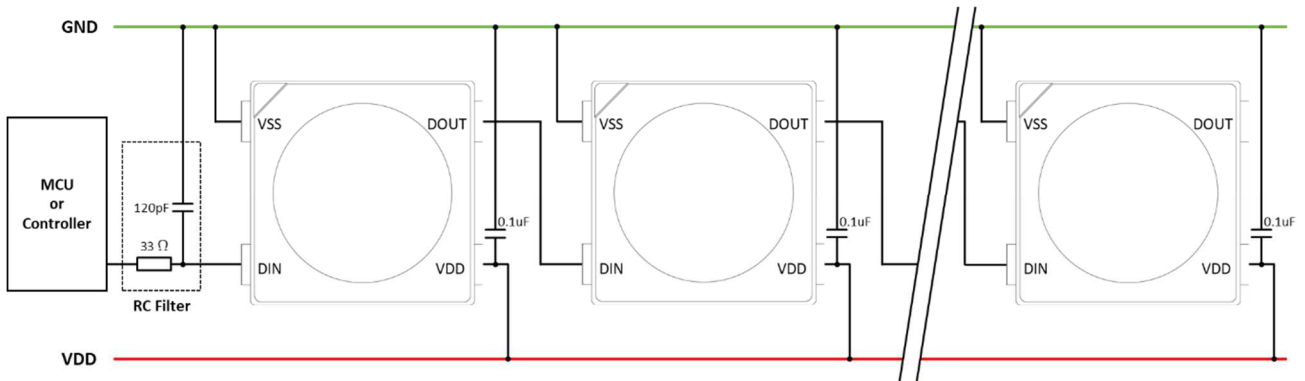

Cascading connection for normal driver IC embedded LEDs is shown. The data signal is transmitted one-by-one. The output of the previous one is connected to the input of the next one. As for the power positive and negative, all LED positives should be connected to VDD and all LED negatives should be connected to ground.

To ensure the function of LED driver IC work normally, every LED positive pin (should be IC Vcc and LED anode individually or commonly) need connect one capacitor. It can guarantee good power feed quality and cascade stability. The recommended capacitance value is 0.1μF. The capacitors should be placed as close to the LED pin as possible to maximize the effect. Besides, the quality of capacitors will affect the effect, too.

The RC filter is necessary to avoid the surge or noise to affect product work normally. The capacitance value 120pF and the resistance value 33ohm is just for reference. The most suitable value is calculated from $f_c = 1/2\pi RC$. The f_c is different by cases and needs to be actually measured.

7.6 ESD (Electrostatic Discharge)

Static Electricity or power surge will damage the LED.

Suggestions to prevent ESD damage:

- Use of a conductive wrist band or anti-electrostatic glove when handling these LEDs.
- All devices, equipment, and machinery must be properly grounded.
- Work tables, storage racks, etc. should be properly grounded.
- Use ion blower to neutralize the static charge which might have built up on surface of the LED's plastic lens as a result of friction between LEDs during storage and handling.

ESD-damaged LEDs will exhibit abnormal characteristics such as high reverse leakage current, low forward voltage, or "no light up" at low currents.

To verify for ESD damage, check for "light up" and V_f of the suspect LEDs at low currents.

The V_f of "good" LEDs should be $>2.0V@0.1mA$ for InGaP product and $>1.4V@0.1mA$ for AlInGaP product.

**SMD LED
LTST-E183CEGBW-TO**

8. Reliability Test

No.	Test item	Test condition	Reference standard
1	Resistance to soldering heat	Tsld = 260°C, 10sec. 3 times	JEITA ED-4701 300 301
2	Solderability	Tsld=245± 5°C (Lead Free Solder, Coverage ≥ 95% of the dipped surface)	JEITA ED-4701 300 303
3	Thermal Shock	85 ± 5°C ~ -30°C ± 5°C 30min 30min 100cycles	JEITA ED-4701 300 307
4	Temperature Cycle	-55°C ~ 25°C ~ 100°C ~ 25°C 30min 5min 30min 5min 100cycles	JEITA ED-4701 100 105
5	High Temperature Storage	100°C 1000hrs	JEITA ED- 4701 200 201
6	Low Temperature Storage	-55°C 1000hrs	JEITA ED-4 701 200 202
7	Temperature Humidity Storage	60°C/90%RH 300hrs	JEITA ED-4701 100 103
8	Room temp life test	25°C, IF: Typical current, 1000 hrs	--

9. Others

The appearance and specifications of the product may be modified for improvement without prior notice.

SMD LED LTST-E183CEGBW-TO

10. Suggested Checking List

Training and Certification

1. Everyone working in a static-safe area is ESD-certified?
2. Training records kept and re-certification dates monitored?

Static-Safe Workstation & Work Areas

1. Static-safe workstation or work-areas have ESD signs?
2. All surfaces and objects at all static-safe workstation and within 1 ft measure less than 100V?
3. All ionizer activated, positioned towards the units?
4. Each work surface mats grounding is good?

Personnel Grounding

1. Every person (including visitors) handling ESD sensitive (ESDS) items wears wrist strap, heel strap or conductive shoes with conductive flooring?
2. If conductive footwear used, conductive flooring also present where operator stand or walk?
3. Garments, hairs or anything closer than 1 ft to ESD items measure less than 100V*?
4. Every wrist strap or heel strap/conductive shoes checked daily and result recorded for all DLs?
5. All wrist strap or heel strap checkers calibration up to date?

Note: *50V for InGaN LED.

Device Handling

1. Every ESDS items identified by EIA-471 labels on item or packaging?
2. All ESDS items completely inside properly closed static-shielding containers when not at static-safe workstation?
3. No static charge generators (e.g. plastics) inside shielding containers with ESDS items?
4. All flexible conductive and dissipative package materials inspected before reuse or recycles?

Others

1. Audit result reported to entity ESD control coordinator?
2. Corrective action from previous audits completed?
3. Are audit records complete and on file?