



Infrared
Product Data Sheet
LTR-S320-TB-L

Spec No. :DS50-2018-0011
Effective Date: 04/20/2018
Revision: -

LITE-ON DCC

RELEASE

BNS-OD-FC001/A4

Detector LTR-S320-TB-L

1. Description

Lite-On offers a broad range of discrete infrared components for application such as remote control, IR wireless data transmission, security alarm & etc. Customers need infrared solutions featuring high power, high speed and wide viewing angles. The product line includes GaAs 940nm IREDs, AlGaAs high speed 850nm IREDs, PIN Photodiodes and Phototransistors. Photodiodes and Phototransistors can be provided with a filter that reduces digital light noise in the sensor function, which enables a high signal-to-noise ratio.

1.1. Features

- Meet ROHS, Green Product.
- Side View With Dark Dome Lens
- Package In 8mm Tape On 7" Diameter Reels.
- Compatible With Automatic placement equipment
- Compatible With infrared reflow solder process
- EIA STD package.

1.2. Applications

- Infrared receiver
- PCB Mounted Infrared Sensor

2. Outline Dimensions

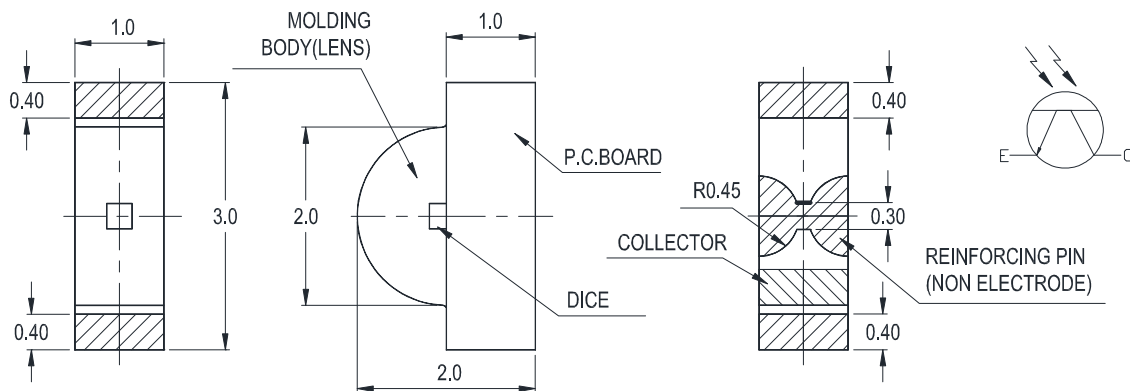

Notes :

1. All dimensions are in millimeters (inches).
2. Tolerance is $\pm 0.1\text{mm}$ (.004") unless otherwise noted.
3. Specifications are subject to change without notice.

Detector LTR-S320-TB-L

3. Absolute Maximum Ratings at TA=25°C

Parameter	Maximum Rating	Unit
Power Dissipation	75	mW
Collector-Emitter Voltage	30	V
Emitter-Collector Voltage	5	V
Operating Temperature Range	-40°C to + 85°C	
Storage Temperature Range	-55°C to + 100°C	
Infrared Soldering Condition	260°C for 10 Seconds	

Suggestion IR Reflow Profile For Pb Free Process:

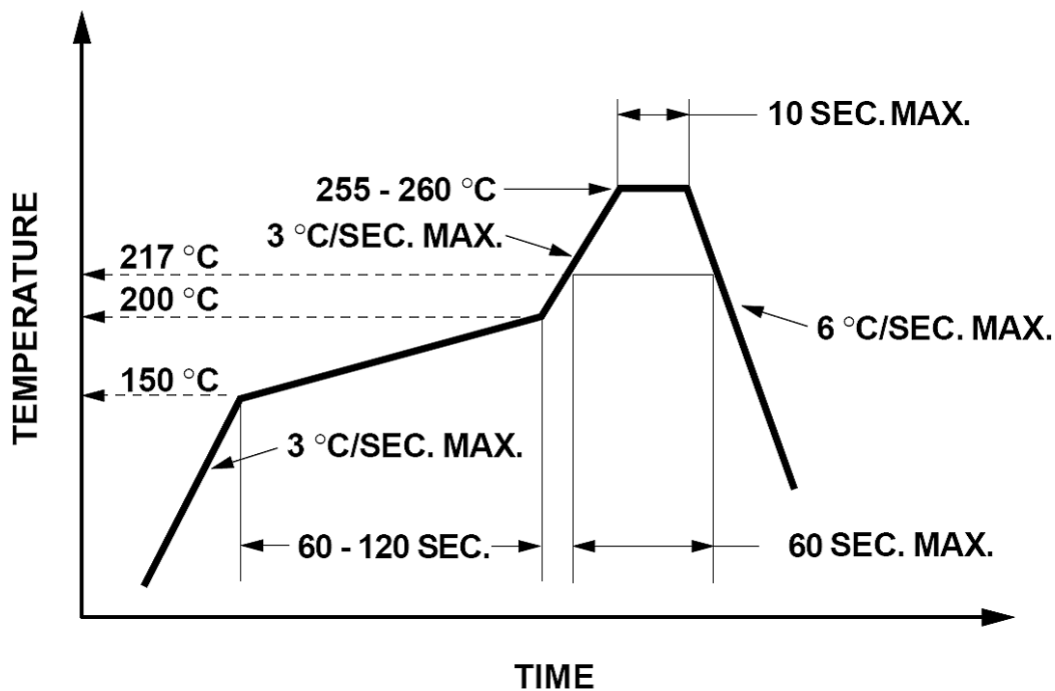

Detector LTR-S320-TB-L

4. Electrical / Optical Characteristics at TA=25°C

Parameter	Symbol	Min.	Typ.	Max.	Unit	Test Condition
Collector-Emitter Breakdown Voltage	$V_{(BR)CEO}$	30	-	-	V	$I_R = 100\mu A$ $E_e = 0mW/cm^2$
Emitter-Collector Breakdown Voltage	$V_{(BR)ECO}$	5	-	-	V	$I_E = 100\mu A$ $E_e = 0mW/cm^2$
Collector Emitter Saturation Voltage	$V_{CE(SAT)}$	-	-	0.4	V	$I_C = 100\mu A$ $E_e = 0.5mW/cm^2$
Peak Sensing Wavelength	λ_p	-	940	-	nm	
Rise Time	T_r	-	15	-	μs	$V_{CE} = 5V$ $I_C = 1mA$ $R_L = 1K\Omega$
Fall Time	T_f	-	15	-	μs	
Collector Dark Current	I_{CEO}	-	-	100	nA	$V_{CE} = 20V$ $E_e = 0mW/cm^2$
On State Collector Current	$I_{C(ON)}$	1.0	2.0	-	mA	$V_{CE} = 5V$ $E_e = 0.5mW/cm^2$ $\lambda = 940nm$

NOTE:

1. Test tolerance of $I_{C(ON)}$ is $\pm 15\%$.

Detector
LTR-S320-TB-L

5. Typical Electrical / Optical Characteristics Curves

(25°C Ambient Temperature Unless Otherwise Noted)

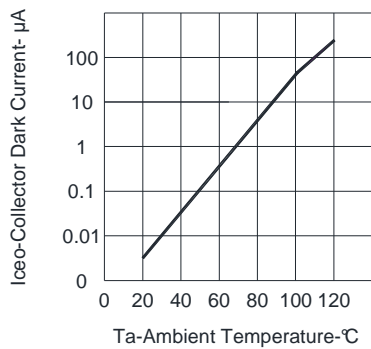

FIG.1 COLLECTOR DARK CURRENT VS AMBIENT TEMPERATURE

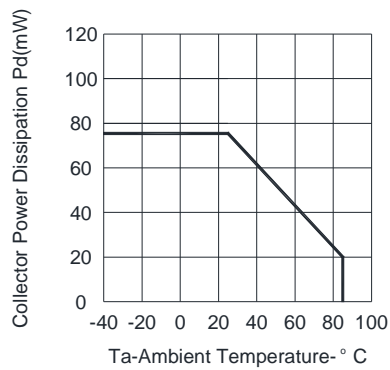

FIG.2 COLLECTOR POWER DISSIPATION VS AMBIENT TEMPERATURE

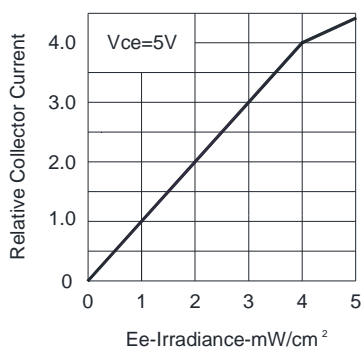

FIG.3 RELATIVE COLLECTOR CURRENT VS IRRADIANCE

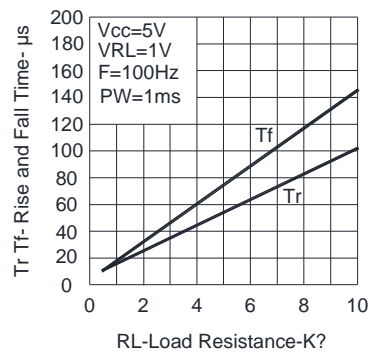

FIG.4 RISE AND FALL TIME VS LOAD RESISTANCE

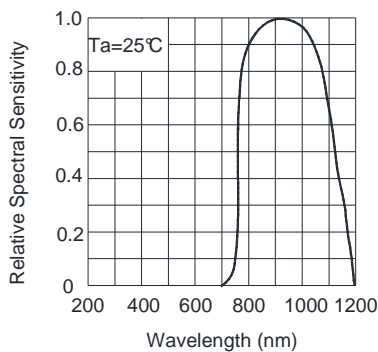

FIG.5 SPECTRAL SENSITIVITY

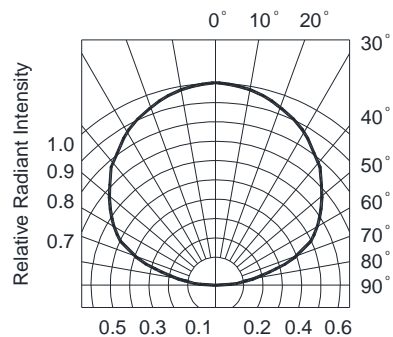
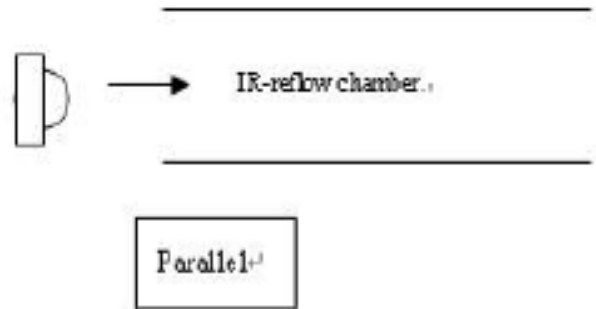
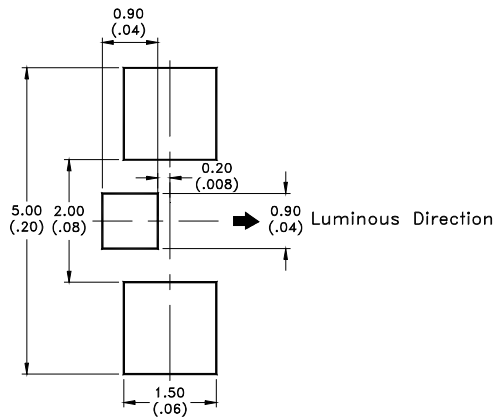

FIG.6 SENSITIVITY DIAGRAM

Detector LTR-S320-TB-L

6. Suggest Soldering Pad Dimensions & Direction



Note: It is recommended that the metal stencil used for solder paste printing has a thickness of 0.1mm (4mils) or 0.12mm (5mils).

7. Package Dimensions Of Tape And Reel

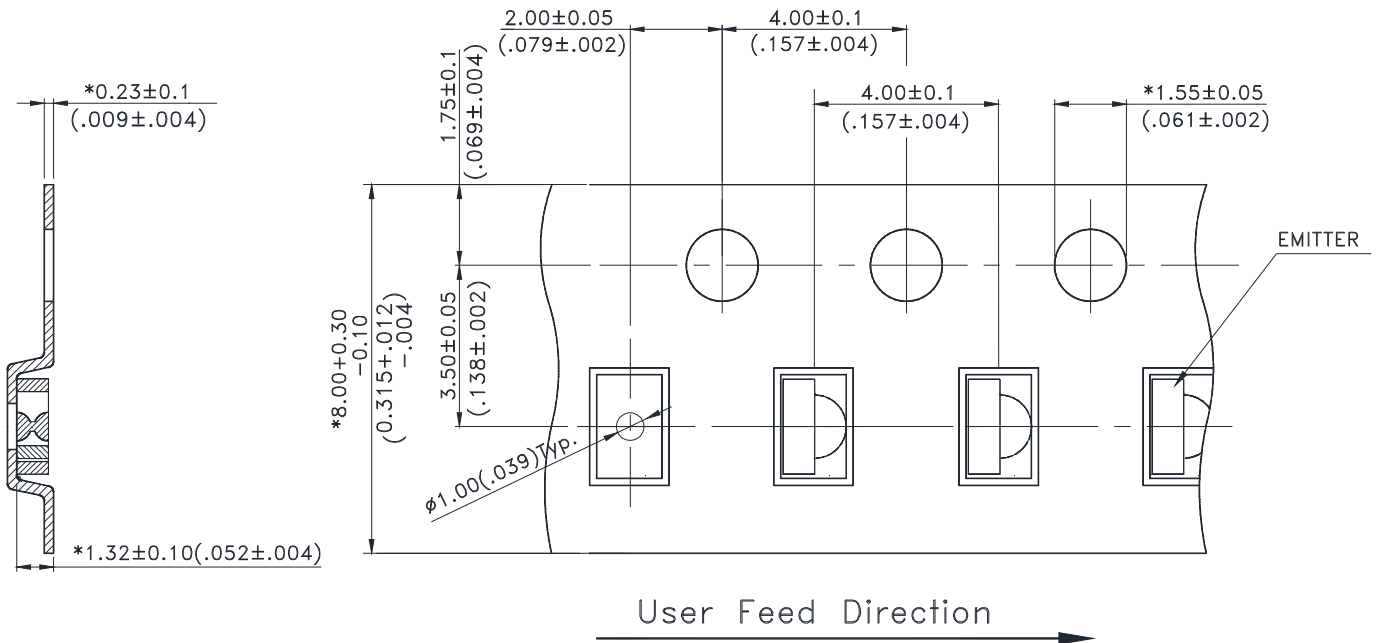

Note: All dimensions are in millimeters (inches).

Detector LTR-S320-TB-L

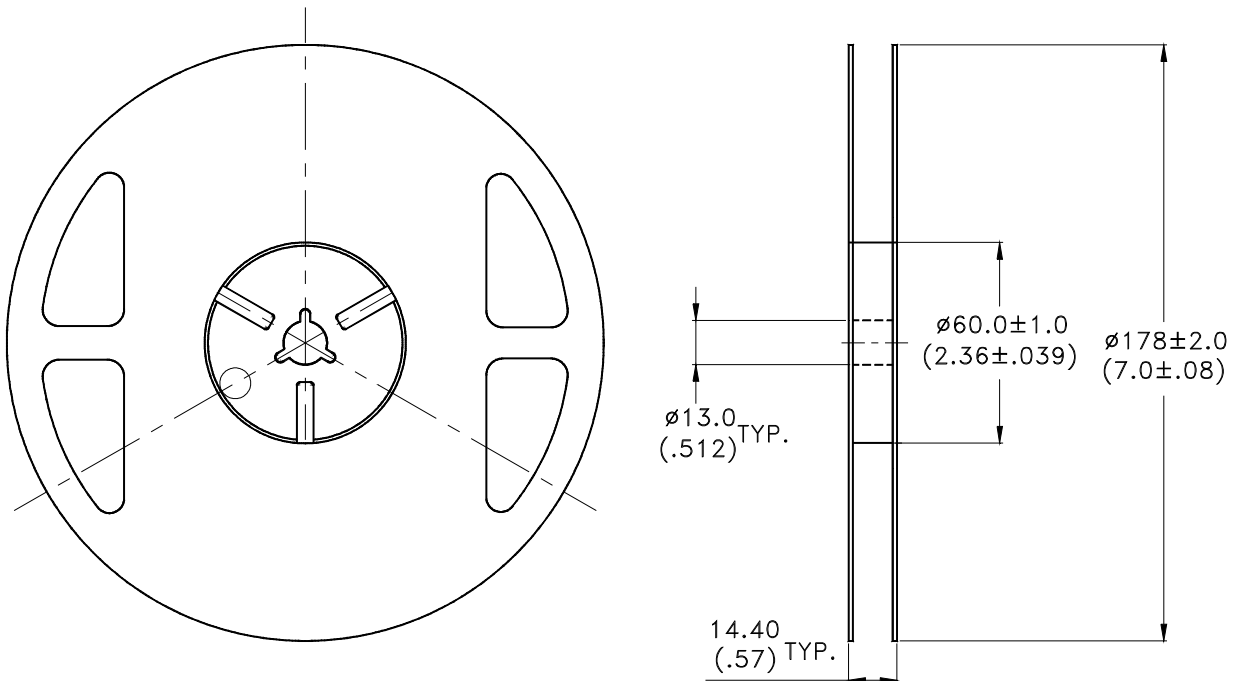

- Note: 1. Empty component pockets sealed with top cover tape.
 2. 7 inch reel-3000 pieces per reel.
 3. Minimum packing quantity is 500 pcs for remainders.
 4. The maximum number of consecutive missing lamps is two.
 5. In accordance with ANSI/EIA 481-1-A-1994 specifications.

8. CAUTIONS

8.1. Application

The LEDs described here are intended to be used for ordinary electronic equipment (such as office equipment, communication equipment and household applications). Consult Liteon's Sales in advance for information on applications in which exceptional reliability is required, particularly when the failure or malfunction of the LEDs may directly jeopardize life or health (such as in aviation, transportation, traffic control equipment, medical and life support systems and safety devices).

8.2. Storage

The package is sealed:

The LEDs should be stored at 30°C or less and 90%RH or less. And the LEDs are limited to use within one year, while the LEDs is packed in moisture-proof package with the desiccants inside.

The package is opened:

The storage ambient for the LEDs should not exceed 30°C temperature or 60% relative humidity.

It is recommended that LEDs out of their original packaging are IR-reflowed within one week hrs.

For extended storage out of their original packaging, it is recommended that the LEDs be stored in a sealed container with appropriate desiccant, or in a desiccators with nitrogen ambient.

LEDs stored out of their original packaging for more than one week hrs should be baked at about 60 deg C for at least 20 hours before solder assembly.

Detector LTR-S320-TB-L

8.3. Cleaning

Use alcohol-based cleaning solvents such as isopropyl alcohol to clean the LEDs if necessary.

8.4. Soldering

Recommended soldering conditions:

Reflow Soldering		Soldering iron	
Pre-heat	150~200°C	Temperature	300°C Max.
Pre-heat time	120 seconds Max.	Soldering time	3 seconds Max. (one time one)
Peak temperature	260°C Max.		
Soldering time	10 seconds Max. (Max. two times)		

Because different board designs use different number and types of devices, solder pastes, reflow ovens, and circuit boards, no single temperature profile works for all possible combinations.

However, you can successfully mount your packages to the PCB by following the proper guidelines and PCB-specific characterization.

LITE-ON Runs both component-level verification using in-house KYRAMX98 reflow chambers and board-level assembly.

The results of this testing are verified through post-reflow reliability testing.

Profiles used at LITE-ON are based on JEDEC standards to ensure that all packages can be successfully and reliably surface mounted.

Figure on page3 shows a sample temperature profile compliant to JEDEC standards.

You can use this example as a generic target to set up your reflow process.

You should adhere to the JEDEC profile limits as well as specifications and recommendations from the solder paste manufacturer to avoid damaging the device and create a reliable solder joint.

8.5. Drive Method

An LED is a current-operated device. In order to ensure intensity uniformity on multiple LEDs connected in parallel in an application, it is recommended that a current limiting resistor be incorporated in the drive circuit, in series with each LED as shown in Circuit A below.

Circuit model (A)

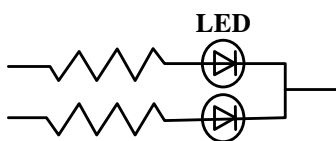

(A) Recommended circuit

Circuit model (B)

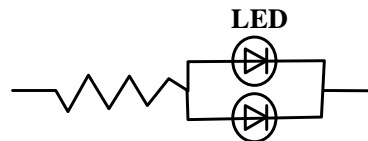

(B) The brightness of each LED might appear different due to the differences in the I-V characteristics of those LEDs.

9. Others

The appearance and specifications of the product may be modified for improvement, without prior notice.