



Photocoupler
Product Data Sheet
LTV-2X5-G SERIES

Spec No. :DS70-2013-0042
Effective Date: 12/25/2018
Revision: F

LITE-ON DCC

RELEASE

BNS-OD-FC001/A4

Photocoupler LTV-2X5 series

1. DESCRIPTION

1.1 Features

- Current transfer ratio (CTR) : 200% Min. at $I_F = 1\text{mA}$, $V_{CE} = 2\text{V}$
- High input-output isolation voltage. ($V_{iso}=3,750\text{Vrms}$)
- Employs double transfer mold technology
- Safety approval:
 - UL 1577
 - VDE DIN EN60747-5-5 (VDE 0884-5)
 - cUL CSA CA5A
- RoHS Compliance: All materials be used in device are followed EU RoHS directive (No.2002/95/EC, 2011/65/EU, and 2015/863).
- Halogen Free
- ESD pass HBM 8000V/MM2000V
- MSL class1

1.2 Applications

- Hybrid substrates that require high density mounting.
- Programmable controllers

Photocoupler LTV-2X5 series

2. PACKAGE DIMENSIONS

2.1 LTV-215

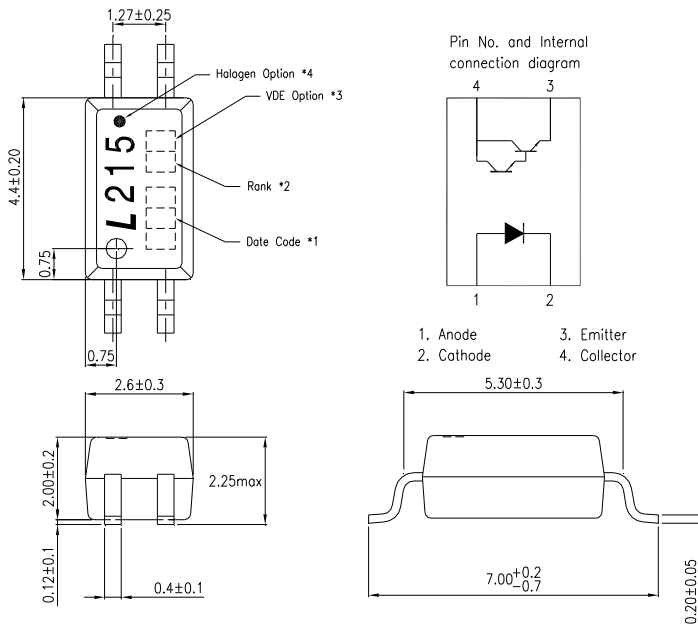

Notes :

- 1-digit year code, Example : 2010 = A
2-digit work week ranging from '01' to '53'
- Rank shall be or shall not be marked.
- VDE mark only appears on devices ordered "V" option.
- "●" for halogen free option.

* Dimensions are in Millimeters and (Inches).

2.2 LTV-245

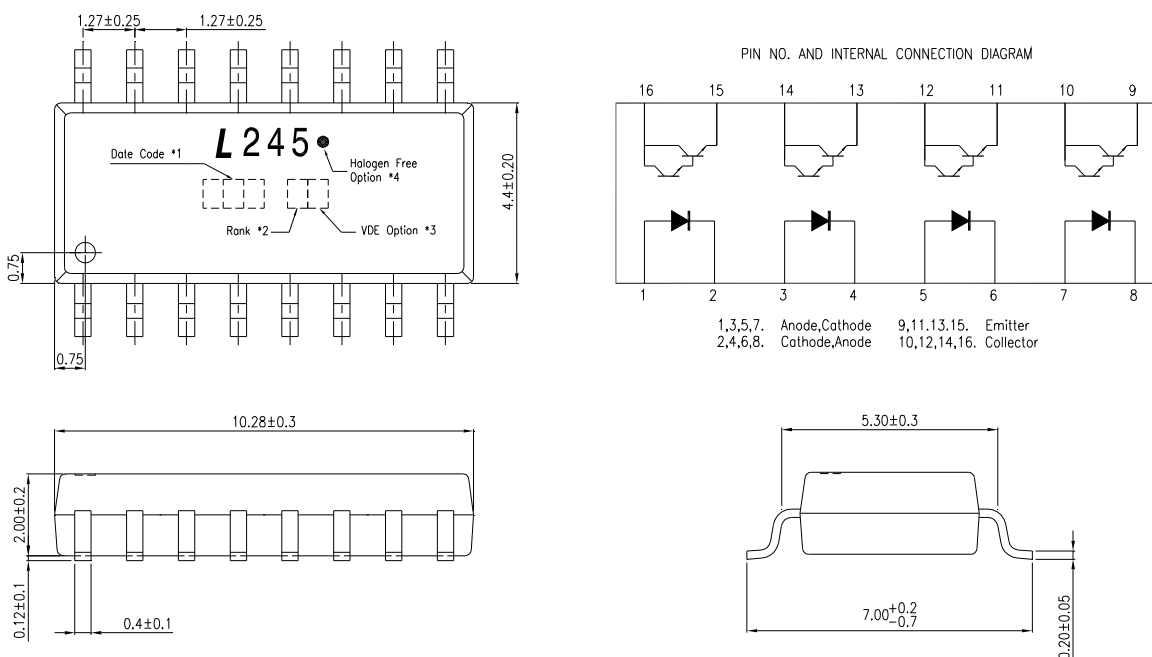

Photocoupler LTV-2X5 series

3. TAPING DIMENSIONS

3.1 LTV-215

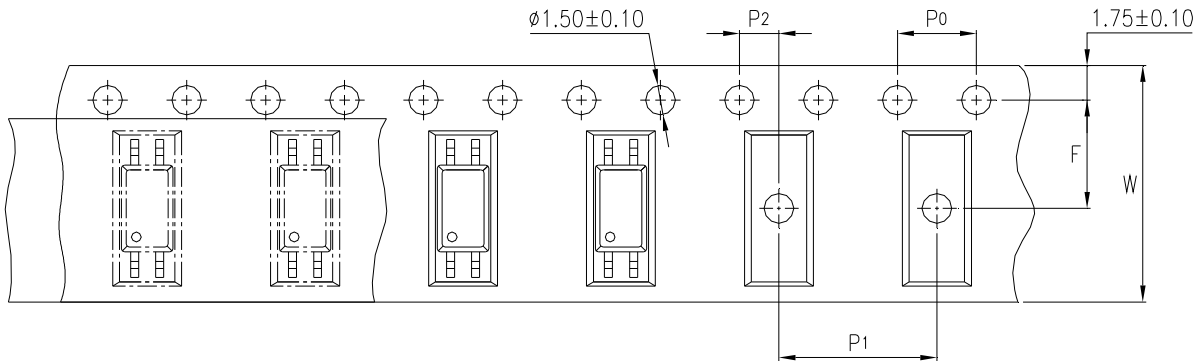

3.2 LTV-215-TP1

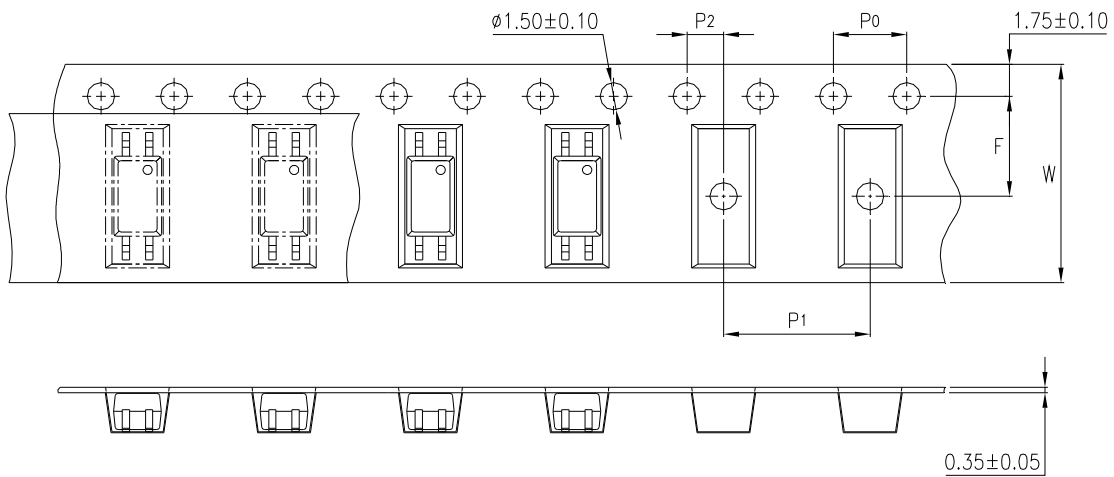

Description	Symbol	Dimension in mm (inch)
Tape wide	W	12±0.3 (0.47)
Pitch of sprocket holes	P ₀	4±0.1 (0.15)
Distance of compartment	F	5.5±0.1 (0.217)
	P ₂	2±0.1 (0.079)
Distance of compartment to compartment	P ₁	8±0.1 (0.315)

Photocoupler LTV-2X5 series

3.3 LTV-245

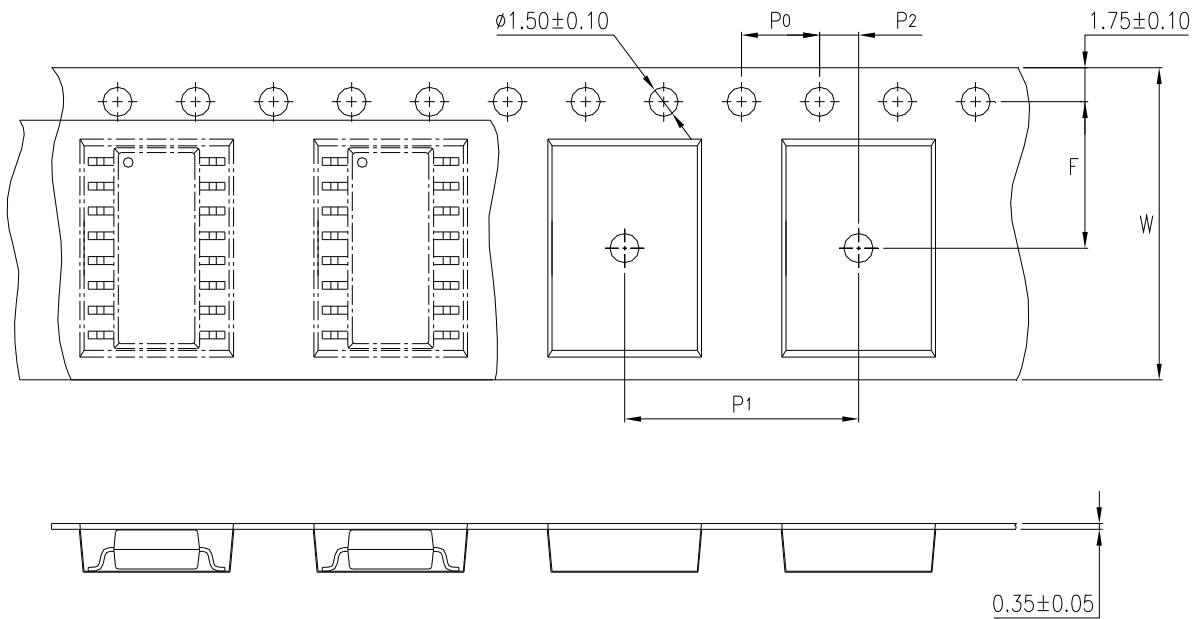

Description	Symbol	Dimension in mm (inch)
Tape wide	W	16±0.3 (0.63)
Pitch of sprocket holes	P ₀	4±0.1 (0.15)
Distance of compartment	F	7.5±0.1 (0.295)
	P ₂	2±0.1 (0.079)
Distance of compartment to compartment	P ₁	12±0.1 (0.472)

3.4 Quantities per Reel

Package Type	LTV-215	LTV-245
Quantities (pcs)	3000	2000

Photocoupler LTV-2X5 series

4. RATING AND CHARACTERISTICS

4.1 Absolute Maximum Ratings at Ta=25°C

	Parameter	Symbol	Rating		Unit
			215	245	
Input	Forward Current	I_F	50		mA
	Reverse Voltage	V_R	6		V
	Power Dissipation	P	60	80	mW
	Pulse Forward Current	I_{FSM}	1		A
	Junction Temperature	T_J	125		°C
Output	Collector - Emitter Voltage	V_{CEO}	40		V
	Emitter - Collector Voltage	V_{ECO}	6		V
	Collector Current	I_C	90	100	mA
	Collector Power Dissipation	P_C	150	100	mW
	Junction Temperature	T_J	125		°C
1.	Isolation Voltage	V_{iso}	3750		V_{rms}
	Operating Temperature	T_{opr}	-55 ~ +100		°C
	Storage Temperature	T_{stg}	-55 ~ +150		°C
2.	Soldering Temperature	T_{sol}	260		°C

1. AC For 1 Minute, R.H. = 40 ~ 60%

Isolation voltage shall be measured using the following method.

- (1) Short between anode and cathode on the primary side and between collector and emitter on the secondary side.
- (2) The isolation voltage tester with zero-cross circuit shall be used.
- (3) The waveform of applied voltage shall be a sine wave.

2. For 10 Seconds

Photocoupler LTV-2X5 series

4.2 ELECTRICAL OPTICAL CHARACTERISTICS at Ta=25°C

Parameter		Symbol	Min.	Typ.	Max.	Unit	Test Condition
Input	Forward Voltage	V_F	—	1.1	1.4	V	$I_F = 5\text{mA}$
	Reverse Current	I_R	—	—	10	μA	$V_R = 5\text{V}$
	Terminal Capacitance	C_t	—	30	250	pF	$V = 0, f = 1\text{KHz}$
Output	Collector Dark Current	I_{CEO}	—	—	400	nA	$V_{CE} = 40\text{V}, I_F = 0$
	Collector-Emitter Breakdown Voltage	BV_{CEO}	40	—	—	V	$I_C = 0.1\text{mA}, I_F = 0$
	Emitter-Collector Breakdown Voltage	BV_{ECO}	6	—	—	V	$I_E = 10\mu\text{A}, I_F = 0$
TRANSFER CHARACTERISTICS	Collector Current	I_C	2	20	—	mA	$I_F = 1\text{mA}$
	1. Current Transfer Ratio	CTR	200	2000	—	%	$V_{CE} = 2\text{V}$
	Collector-Emitter Saturation Voltage	$V_{CE(sat)}$	—	—	1.0	V	$I_F = 1\text{mA}$ $I_C = 2\text{mA}$
	Isolation Resistance	R_{iso}	5×10^{10}	1×10^{11}	—	Ω	DC500V, 40 ~ 60% R.H.
	Floating Capacitance	C_f	—	0.6	1	pF	$V = 0, f = 1\text{MHz}$
	Response Time (Rise)	t_r	—	200	—	μs	$V_{CC} = 5\text{V}, I_C = 2\text{mA},$
	Response Time (Fall)	t_f	—	200	—	μs	$RL = 100\Omega$

$$1. \text{CTR} = \frac{I_C}{I_F} \times 100\%$$

**Photocoupler
LTV-2X5 series**

5. RANK TABLE OF CURRENT TRANSFER RATIO CTR

MODEL NO.	Rank	Min	Max	Condition
LTV-215	No mark	200	—	$I_F=1\text{mA}$, $V_{CE}=2\text{V}$, $T_a=25^\circ\text{C}$
LTV-245	K	2000	—	

Photocoupler LTV-2X5 series

6. CHARACTERISTICS CURVES (TYPICAL PERFORMANCE)

Figure 1. Diode Power Dissipation vs. Ambient Temperature

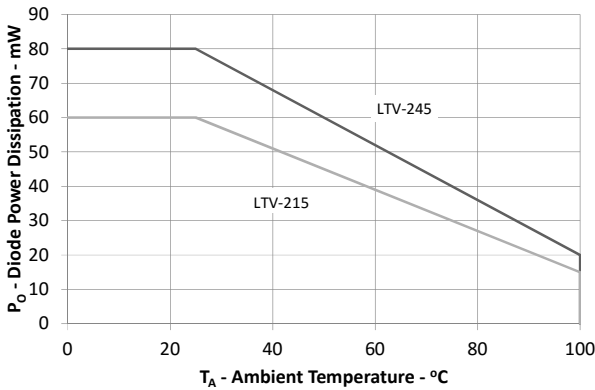

Figure 2. Transistor Power Dissipation vs. Ambient Temperature

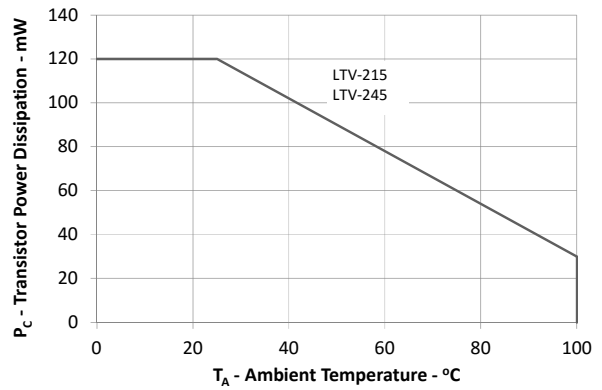

Figure 3. Forward Current vs. Forward Voltage

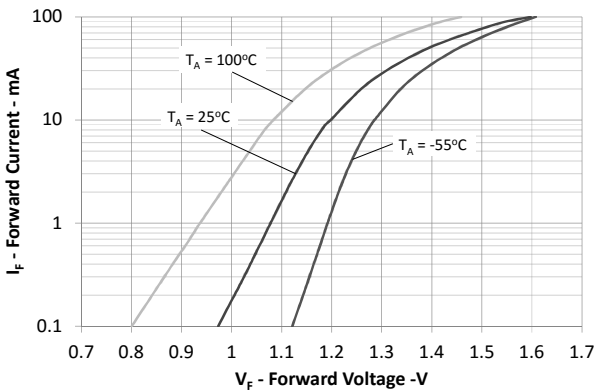

Figure 4. Collector Current vs. Non-Saturated Collector to Emitter Voltage

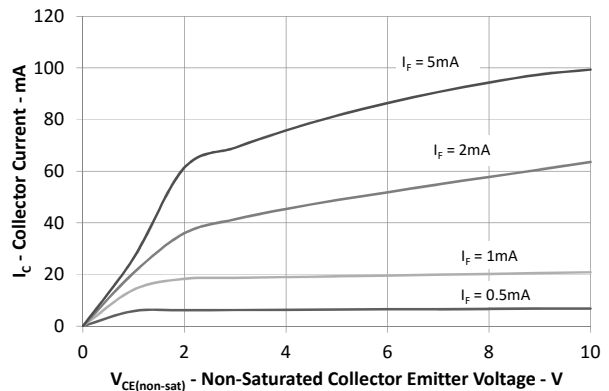

Figure 5. Collector to Emitter Dark Current vs. Ambient Temperature

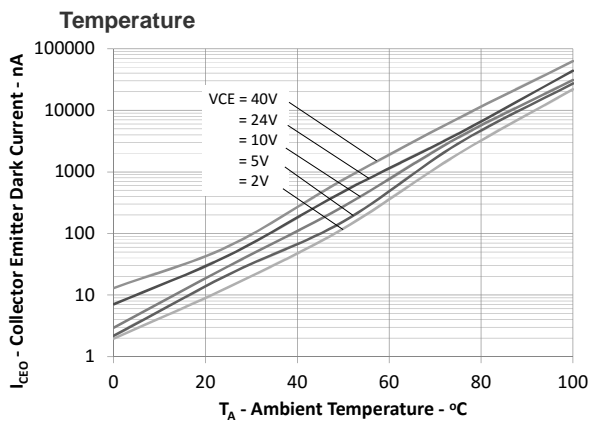
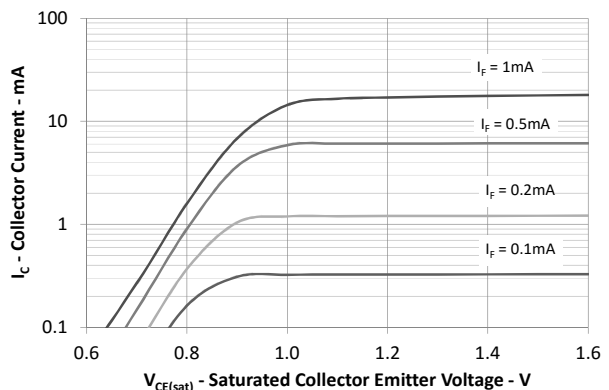

Figure 6. Collector Current vs. Saturated Collector to Emitter Voltage



Photocoupler LTV-2X5 series

Figure 7. Normalized Current Transfer Ratio vs. Ambient Temperature

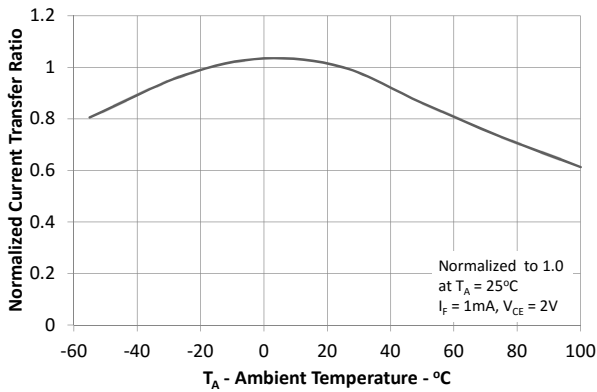

Figure 8. Current Transfer Ratio vs. Forward Current

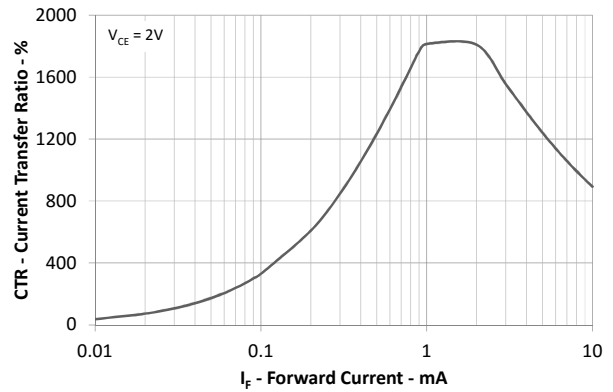

Figure 9. Switching Time vs. Load Resistance

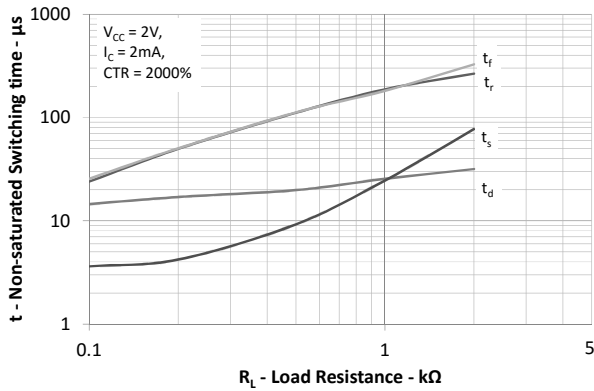
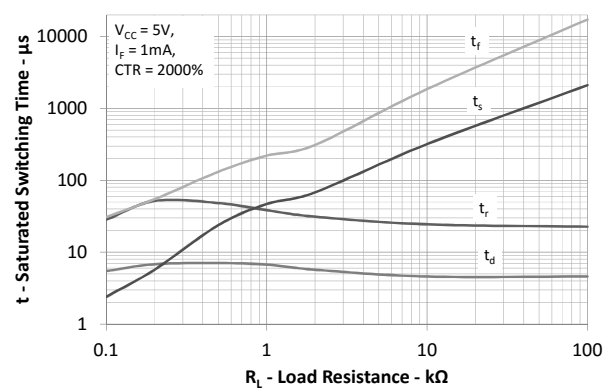
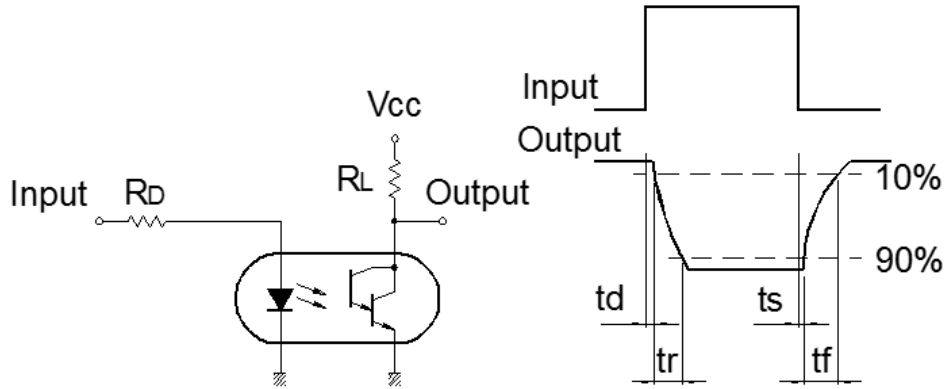

Figure 10. Switching Time vs. Load Resistance



**Photocoupler
LTV-2X5 series**

7. SWITCHING TIME TEST CIRCUIT



8. TEMPERATURE PROFILE OF SOLDERING

8.1 IR Reflow soldering (JEDEC-STD-020C compliant)

One time soldering reflow is recommended within the condition of temperature and time profile shown below. Do not solder more than three times.

Profile item	Conditions
Preheat	
- Temperature Min (T_{Smin})	150°C
- Temperature Max (T_{Smax})	200°C
- Time (min to max) (t_s)	90±30 sec
Soldering zone	
- Temperature (T_L)	217°C
- Time (t_L)	60 sec
Peak Temperature (T_P)	260°C
Ramp-up rate	3°C / sec max.
Ramp-down rate	3-6°C / sec

Photocoupler
LTV-2X5 series

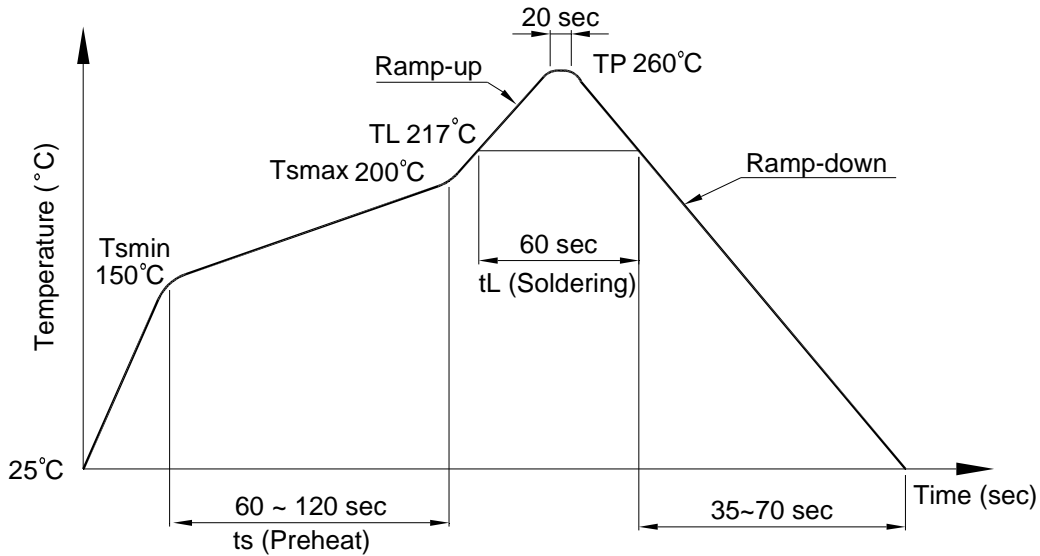

8.2 Wave soldering (JEDEC22A111 compliant)

One time soldering is recommended within the condition of temperature.

Temperature: 260+0/-5°C

Time: 10 sec.

Preheat temperature: 25 to 140°C

Preheat time: 30 to 80 sec.

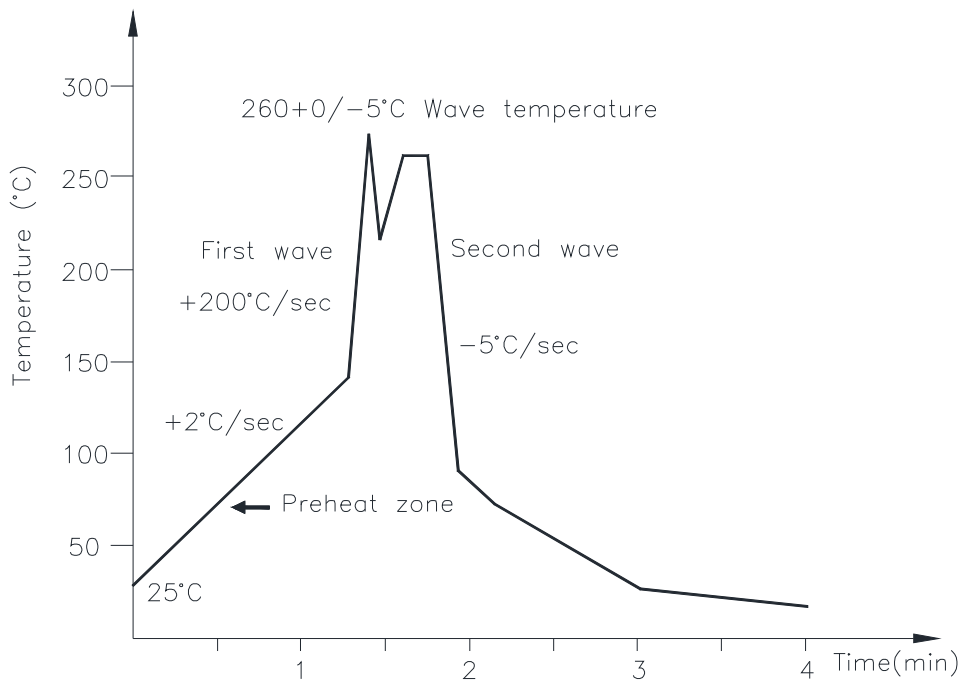

**Photocoupler
LTV-2X5 series**

8.3 Hand soldering by soldering iron

Allow single lead soldering in every single process. One time soldering is recommended.

Temperature: 380+0/-5°C

Time: 3 sec max.

9. RECOMMENDED FOOT PRINT PATTERNS (MOUNT PAD)

Unit: mm

9.1 LTV-215

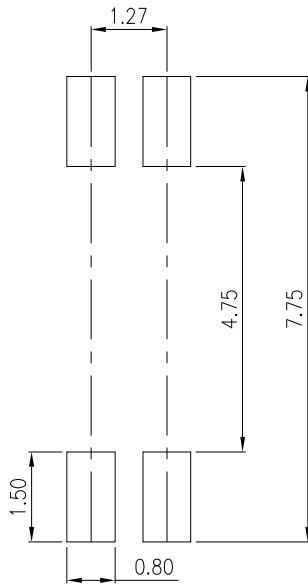

9.2 LTV-245

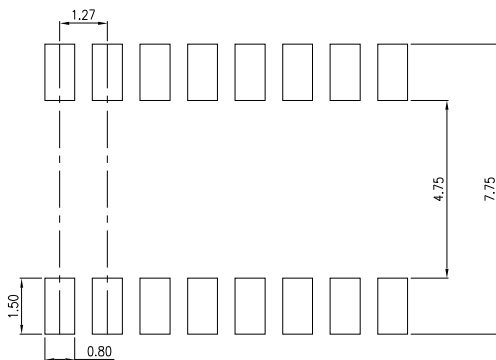

**Photocoupler
LTV-2X5 series**

10. NAMING RULE

LTV-2X5-(1)-(2)-G

DEVICE PART NUMBER

(1) TAPING TYPE (TP1 or no suffix)

Please refer to orientation of taping on Page P3-P4

(2) CTR RANK

Please refer to the CTR table on Page P7

(3) Halogen free option

Example : LTV-215-TP1-K-G

LTV2X5(1)(2)-V-G

DEVICE PART NUMBER

(1) TAPING TYPE (TP1 or no suffix)

Please refer to orientation of taping on Page P3-P4

(2) CTR RANK

Please refer to the CTR table on Page P7

(3) VDE order option

(4) Halogen free option

Example : LTV215TP1K-V-G

11. NOTES

- LiteOn is continually improving the quality, reliability, function or design and LiteOn reserves the right to make changes without further notices.
- The products shown in this publication are designed for the general use in electronic applications such as office automation equipment, communications devices, audio/visual equipment, electrical application and instrumentation.
- For equipment/devices where high reliability or safety is required, such as space applications, nuclear power control equipment, medical equipment, etc, please contact our sales representatives.
- When requiring a device for any "specific" application, please contact our sales in advance.
- If there are any questions about the contents of this publication, please contact us at your convenience.
- The contents described herein are subject to change without prior notice.
- Immerge unit's body in solder paste is not recommended.