



Photocoupler

Product Data Sheet

LTV-4506 series

Spec No.: DS70-2016-0065

Effective Date: 11/01/2016

Revision: -

LITE-ON DCC

RELEASE

BNS-OD-FC001/A4

Photocoupler LTV-4506 series

Intelligent Power Module and Gate Drive Interface Photocoupler

1. DESCRIPTION

The LTV-4506 series contain a AlGaAs LED optically coupled to an integrated high gain photo detector. Minimized propagation delay difference between devices, make these Photocouplers excellent solutions for improving inverter efficiency through reduced switching dead time. Specifications and performance plots are given for typical IPM applications, Analog applications.

1.1 Features

- Performance specified for common IPM applications over industrial temperature range.
- Short maximum propagation delays
- Minimized pulse width distortion (PWD)
- Very high common mode rejection (CMR)
- High CTR
- MSL Level 1
- Safety approval:
 - UL/ cUL Recognized 5000 $V_{RMS}/1$ min
 - IEC/EN/DIN EN 60747-5-5 $V_{IORM} = 630$ V_{peak}

1.2 Specifications

- Wide operating temperature range: $-40^{\circ}C$ to $100^{\circ}C$.
- Maximum propagation delay $t_{PHL} = 400ns$, $t_{PLH} = 550ns$
- Maximum pulse width distortion (PWD) = 450ns
- 15 $kV/\mu s$ minimum common mode transient immunity (CMTI) at $V_{CM} = 1500$ V.
- CTR > 44% at $I_F = 10$ mA

1.3 Applications

- IPM Isolation
- Isolated IGBT/MOSFET Gate Drive
- AC and Brushless DC Motor Drives
- Industrial Inverters

Functional Diagram

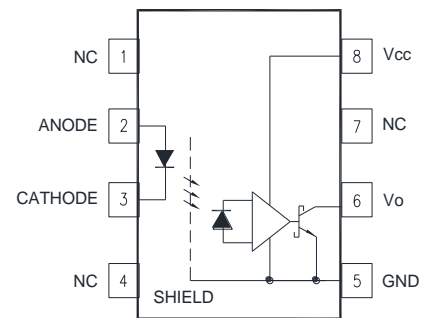

Note: A 0.1 μF bypass capacitor must be connected between Pin 5 and 8.

Truth Table

LED	V_o
ON	LOW
OFF	HIGH

Photocoupler LTV-4506 series

2. PACKAGE DIMENSIONS

2.1 LTV-4506

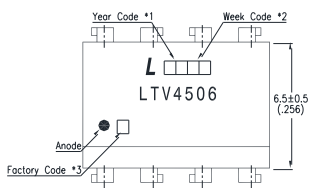

2.2 LTV-4506M

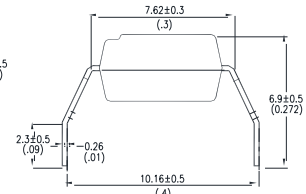
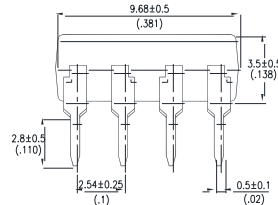
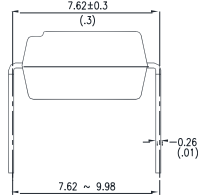
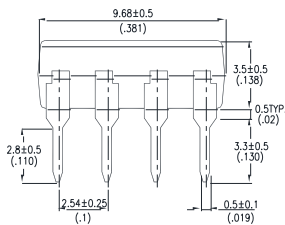
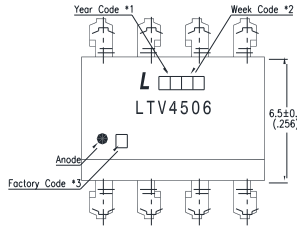

2.3 LTV-4506S

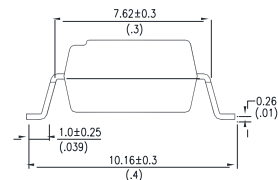
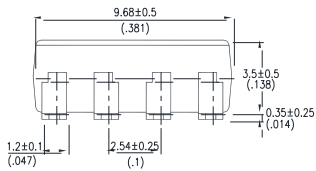
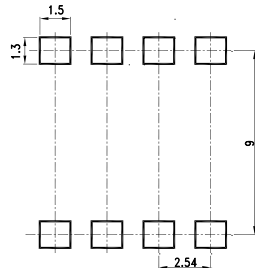
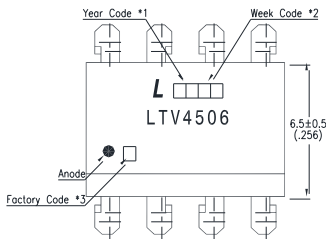

Notes :

1. Year date code.
2. 2-digit work week.
3. Factory identification mark (Y : Thailand).

* Dimensions are in Millimeters and (Inches).

Photocoupler LTV-4506 series

3. TAPING DIMENSIONS

3.1 LTV-4506S-TA

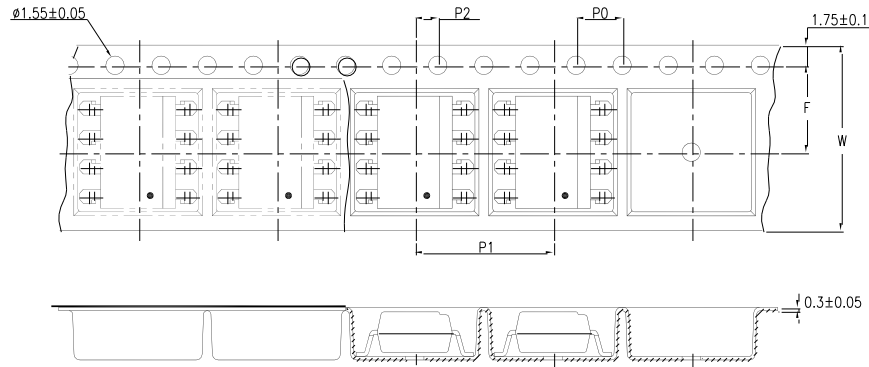

3.2 LTV-4506S-TA1

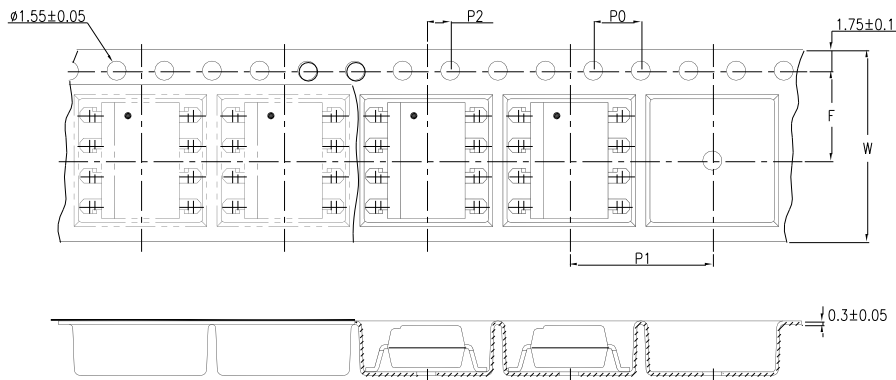

Description	Symbol	Dimension in mm (inch)
Tape wide	W	16±0.3 (0.63)
Pitch of sprocket holes	P ₀	4±0.1 (0.15)
Distance of compartment	F	7.5±0.1 (0.295)
	P ₂	2±0.1 (0.079)
Distance of compartment to compartment	P ₁	12±0.1 (0.47)

3.3 Quantities Per Reel

Package Type	LTV-4506 series
Quantities (pcs)	1000

Photocoupler LTV-4506 series

4. RATING AND CHARACTERISTICS

4.1 Absolute Maximum Ratings

	Parameter	Symbol	Min.	Max.	Unit	Note
Input	Average Input Current	$I_{F(av)}$	—	25	mA	—
	Peak Transient Input Current ($<1\mu s$ pulse width, 300pps)	$I_{F(tran)}$	—	1.0	A	—
	Reverse Input Voltage	V_R	—	5	V	—
Output	Output Collector Current	$I_{O(av)}$	—	15	mA	—
	Output Voltage (Pin 6-5)	V_O	-0.5	30	V	—
	Supply Voltage (Pin 8-5)	V_{CC}	-0.5	30	V	—
	Output Power Dissipation	P_o	—	145	mW	—
	Operating Temperature	T_{opr}	-40	100	°C	—
	Storage Temperature	T_{stg}	-55	125	°C	—

Note: Ambient temperature = 25°C, unless otherwise specified. Stresses exceeding the absolute maximum ratings can cause permanent damage to the device. Exposure to absolute maximum ratings for long periods of time can adversely affect reliability.

Note: A ceramic capacitor (0.1 μF) should be connected between pin 5 and pin 8 to stabilize the operation of a high gain linear amplifier. Otherwise, this Photocoupler may not switch properly. The bypass capacitor should be placed within 1 cm of each pin.

4.2 Recommended Operating Conditions

Parameter	Symbol	Min	Max	Unit
Operating Temperature	T_A	-40	100	°C
Supply Voltage	V_{CC}	4.5	30	V
Output Voltage	V_O	0	30	V
Input Current (ON)	$I_{F(ON)}$	10	20	mA
Input Voltage (OFF)	$V_{F(OFF)}$	-5	0.8	V

Photocoupler LTV-4506 series

4.3 ELECTRICAL OPTICAL CHARACTERISTICS

	Parameter	Symbol	Min.	Typ.	Max.	Unit	Test Condition	Fig.	Note
Input	Input Forward Voltage	V_F	—	1.38	1.8	V	$I_F = 10\text{mA}$	4	—
	Input Forward Voltage Temperature Coefficient	$\Delta V_F / \Delta T$	—	-1.6	—	mV/°C	$I_F = 10\text{mA}$	—	—
	Input Reverse Voltage	BV_R	5	—	—	V	$I_R = 10\mu\text{A}$	—	—
	Input Threshold Current	I_{TH}	—	1.5	5	mA	$V_O = 0.8\text{ V},$ $I_O = 0.75\text{mA}$	1	1
	Input Capacitance	C_{IN}	—	34	—	pF	$f = 1\text{ MHz},$ $V_F = 0\text{ V}$	—	—
	Output	Current Transfer Rtion	CTR	44	120	—	%	$I_F = 10\text{mA},$ $V_O = 0.6\text{V}$	—
Low Level Output Current		I_{OL}	4.4	12	—	mA	$I_F = 10\text{ mA},$ $V_O = 0.6\text{ V}$	1,2	—
High Level Supply Current		I_{CCH}	—	0.7	1.3	mA	$V_F = 0.8\text{ V},$ $V_O = \text{Open}$	—	1
Low Level Supply Current		I_{CCL}	—	0.7	1.3	mA	$I_F = 10\text{ mA},$ $V_O = \text{Open}$	—	1
High level output current		I_{OH}	—	1	50	μA	$V_F = 0.8\text{ V}$	3	—
Low Level Output Voltage		V_{OL}	—	0.15	0.4	V	$I_O = 2.4\text{ mA}$	—	—

Over recommended operating conditions unless otherwise specified. $T_A = -40^\circ\text{C}$ to $+100^\circ\text{C}$, $V_{CC} = +4.5\text{ V}$ to 30 V , $I_F(\text{on}) = 10\text{ mA}$ to 20 mA , $V_{F(\text{off})} = -5\text{ V}$ to 0.8 V

Note 1: Use of a $0.1\ \mu\text{F}$ bypass capacitor connected between pins 5 and 8 can improve performance by filtering power supply line noise.

Note 2: CURRENT TRANSFER RATIO in percent is defined as the ratio of output collector current (I_O) to the forward LED input current (I_F) times 100.

Photocoupler LTV-4506 series

4.4 SWITCHING SPECIFICATION

Parameter	Symbol	Min.	Typ.	Max.	Unit	Test Condition	Fig.	Note				
Propagation Delay Time to Low Output Level	t_{PHL}	30	140	400	ns	$C_L = 100\text{pF}$	$I_{F(on)} = 10\text{mA}$, $V_{F(off)} = 0.8\text{V}$, $V_{CC} = 15.0\text{V}$, $V_{THLH} = 2.0\text{V}$, $V_{THHL} = 1.5\text{V}$	5,7-11	1, 2			
		—	125	—		$C_L = 10\text{pF}$						
Propagation Delay Time to High Output Level	t_{PLH}	270	440	550		$C_L = 100\text{pF}$						
		—	170	—		$C_L = 10\text{pF}$						
Pulse Width Distortion	PWD	—	300	450		$C_L = 100\text{pF}$					—	3
Propagation Delay Difference Between Any 2 Parts	$t_{PLH} - t_{PHL}$	-150	—	450		—					—	4
Output High Level Common Mode Transient Immunity	$ CM_H $	15	30	—	kV/ μs	$I_F = 0\text{mA}$, $V_O > 3.0\text{V}$	$V_{CC} = 15.0\text{V}$, $C_L = 100\text{pF}$, $V_{CM} = 1500V_{P-P}$	6	5			
Output Low Level Common Mode Transient Immunity	$ CM_L $	15	30	—	kV/ μs	$I_F = 10\text{mA}$, $V_O < 1.0\text{V}$	$T_A = 25^\circ\text{C}$	—	6			

Over recommended operating conditions unless otherwise specified. $T_A = -40^\circ\text{C}$ to $+100^\circ\text{C}$, $V_{CC} = +4.5\text{V}$ to 30V , $I_{F(on)} = 10\text{mA}$ to 20mA , $V_{F(off)} = -5\text{V}$ to 0.8V

Note 1: Use of a $0.1\ \mu\text{F}$ bypass capacitor connected between pins 5 and 8 can improve performance by filtering power supply line noise.

Note 2: Pulse: $f = 20\text{kHz}$, Duty Cycle = 10%.

Note 3: Pulse Width Distortion (PWD) is defined as $|t_{PHL} - t_{PLH}|$ for any given device.

Note 4: The difference between t_{PLH} and t_{PHL} between any two parts under the same test condition.

Note 5: Common mode transient immunity in a Logic High level is the maximum tolerable dV_{CM}/dt of the common mode pulse, V_{CM} , to assure that the output will remain in a Logic High state (i.e., $V_O > 3.0\text{V}$).

Note 6: Common mode transient immunity in a Logic Low level is the maximum tolerable dV_{CM}/dt of the common mode pulse, V_{CM} , to assure that the output will remain in a Logic Low state (i.e., $V_O < 1.0\text{V}$).

Photocoupler LTV-4506 series

5. ISOLATION CHARACTERISTIC

Parameter	Symbol	Min.	Typ.	Max.	Unit	Test Condition	Note
Withstand Insulation Test Voltage	V_{ISO}	5000	—	—	V	RH \leq 40%-60%, t = 1min, $T_A = 25^\circ\text{C}$	1, 2
Input-Output Resistance	R_{I-O}	—	10^{12}	—	Ω	$V_{I-O} = 500\text{V DC}$	1
Input-Output Capacitance	C_{I-O}	—	0.92	—	pF	f = 1MHz, $T_A = 25^\circ\text{C}$	1

All Typical values at $T_A = 25^\circ\text{C}$ unless otherwise specified.

Note 1: Device is considered a two terminal device: pins 1, 2, 3 and 4 are shorted together and pins 5, 6, 7 and 8 are shorted together.

Note 2: According to UL1577, each photocoupler is tested by applying an insulation test voltage $6000V_{RMS}$ for one second (leakage current less than $10\mu\text{A}$). This test is performed before the 100% production test for partial discharge

6. TYPICAL PERFORMANCE CURVES & TEST CIRCUITS

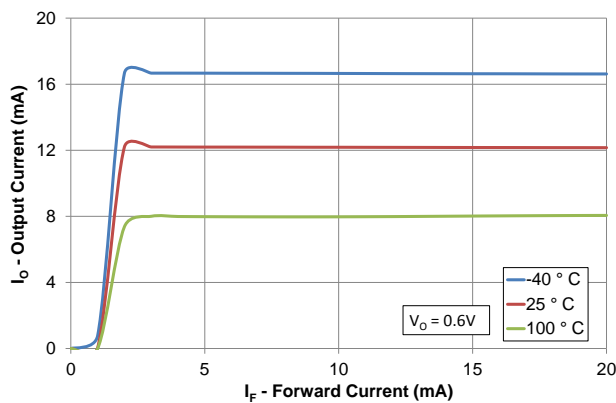

Figure 1: Typical Transfer Characteristics

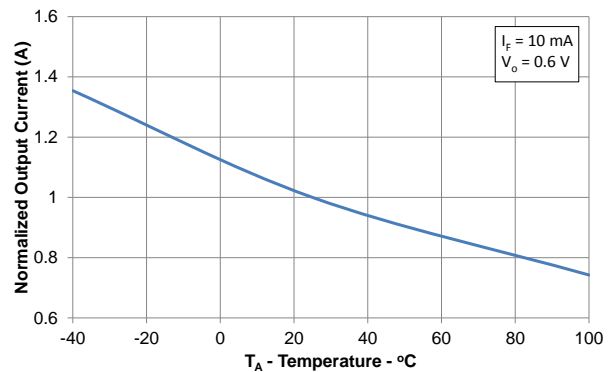

Figure 2: Normalized Output Current vs. Temperature

Photocoupler LTV-4506 series

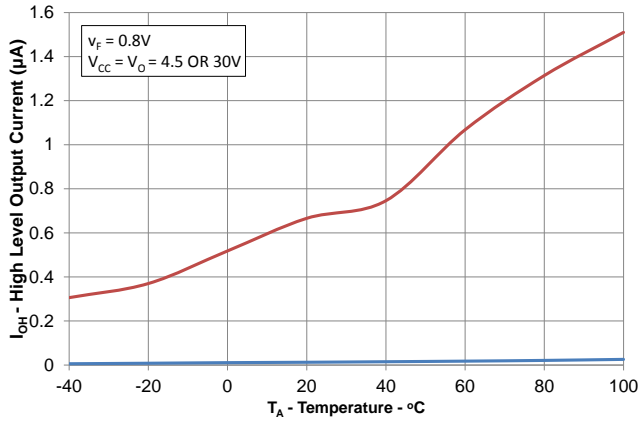

Figure 3: High Level Output Current vs. Temperature

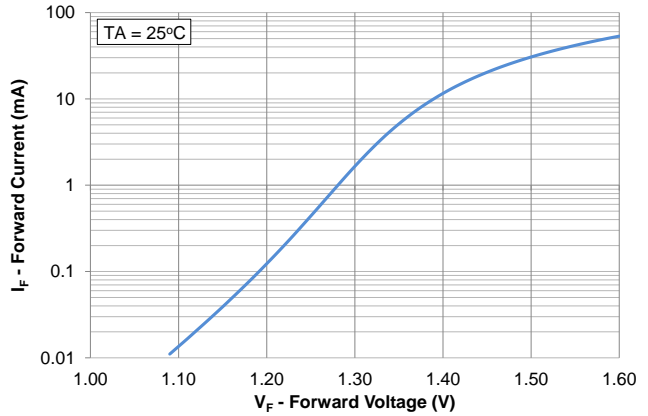

Figure 4: Input Current vs. Forward Voltage

$I_F = 10 \text{ mA (P.G.)}$
 $(f = 20 \text{ kHz, duty} = 10\%, t_r = t_f = \text{less than } 5 \text{ ns})$

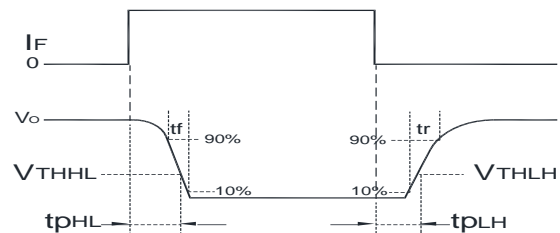
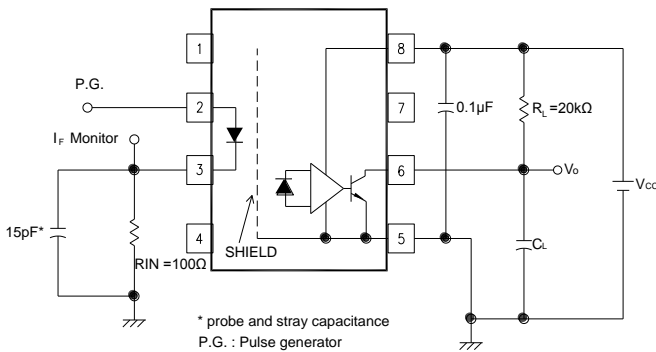

Figure 5 : Propagation Delay Test Circuit.

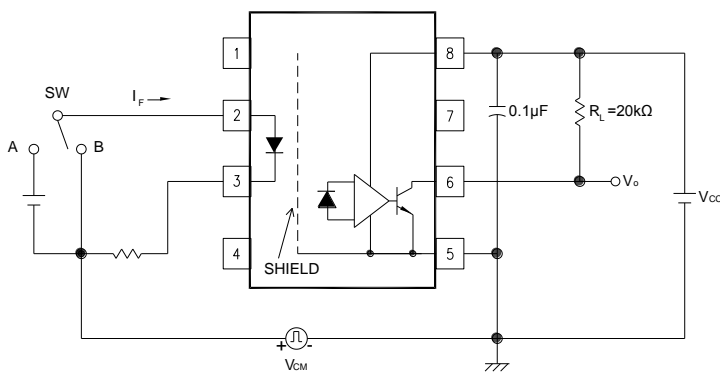

Figure 6 : CMR Test Circuit and Waveforms

Photocoupler LTV-4506 series

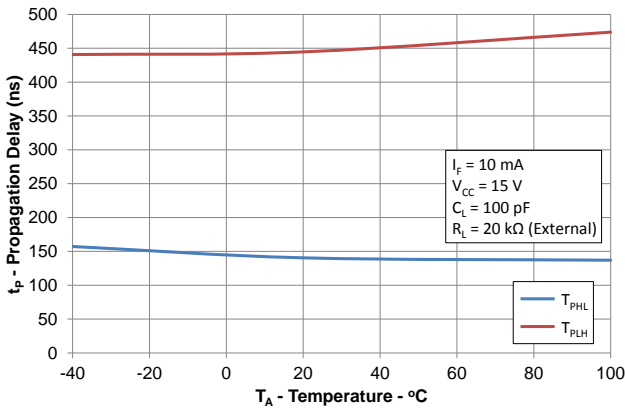

Figure 7: Propagation Delay vs. Temperature

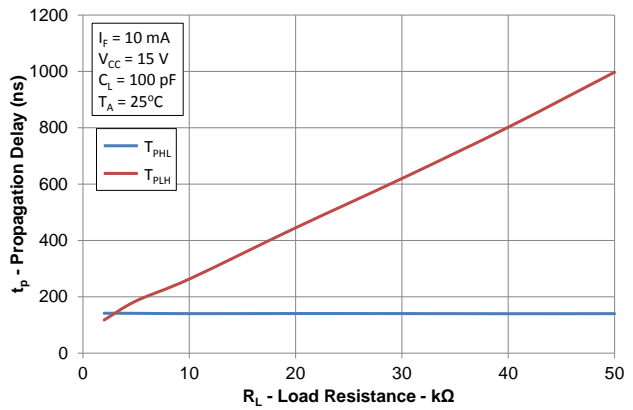

Figure 8: Propagation Delay vs. Load Resistance

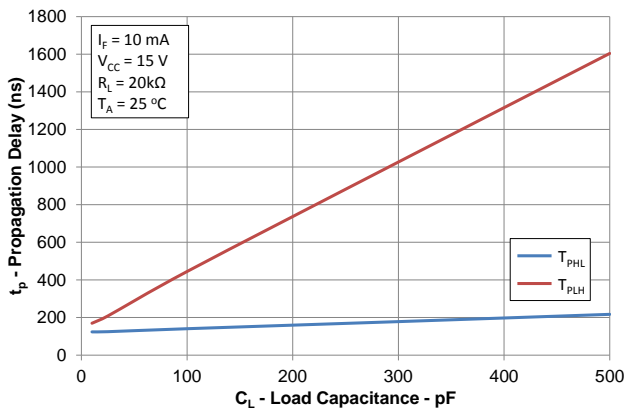

Figure 9: Propagation Delay vs. Load Capacitance.

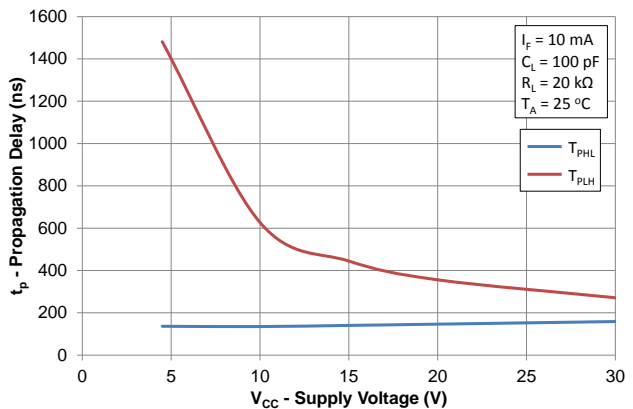

Figure 10: Propagation Delays vs. Supply Voltage

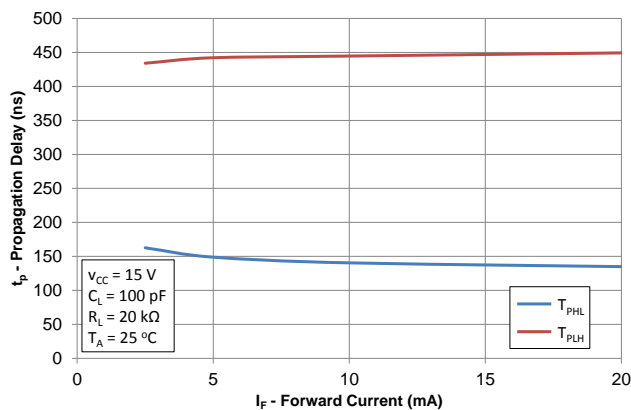

Figure 11: Propagation Delay vs. Input Current.

Photocoupler LTV-4506 series

7. TEMPERATURE PROFILE OF SOLDERING

7.1 IR Reflow soldering (JEDEC-STD-020C compliant)

One time soldering reflow is recommended within the condition of temperature and time profile shown below. Do not solder more than three times.

Profile item	Conditions
Preheat	
- Temperature Min (T_{Smin})	150°C
- Temperature Max (T_{Smax})	200°C
- Time (min to max) (ts)	90±30 sec
Soldering zone	
- Temperature (T_L)	217°C
- Time (t_L)	60 ~ 100 sec
Peak Temperature (T_P)	260°C
Ramp-up rate	3°C / sec max.
Ramp-down rate	3~6°C / sec

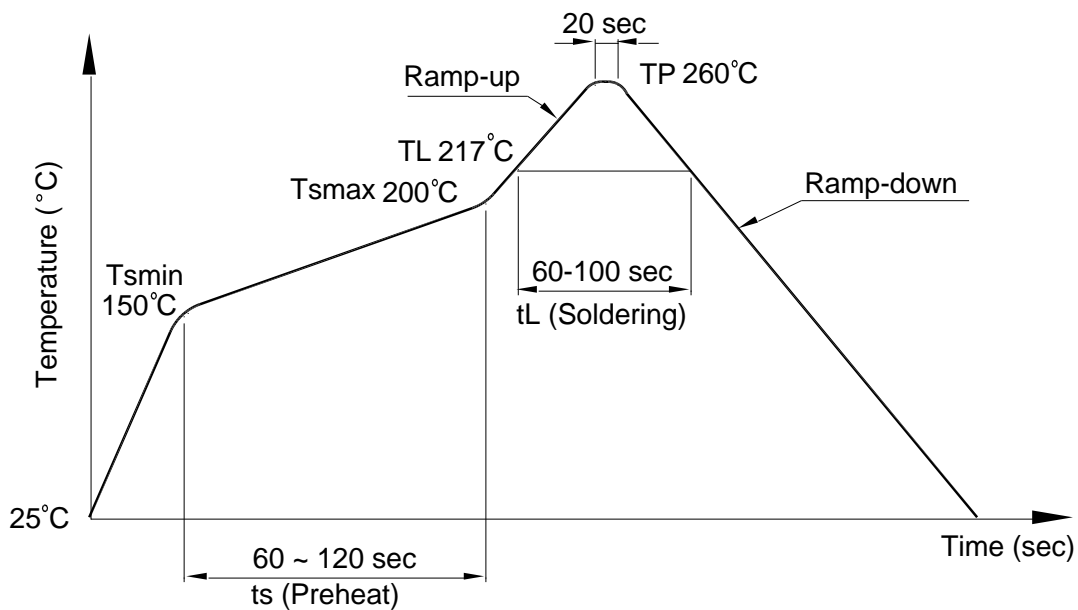

Photocoupler LTV-4506 series

7.2 Wave soldering (JEDEC22A111 compliant)

One time soldering is recommended within the condition of temperature.

Temperature: $260 \pm 0 / -5^{\circ}\text{C}$

Time: 10 sec.

Preheat temperature: 25 to 140°C

Preheat time: 30 to 80 sec.

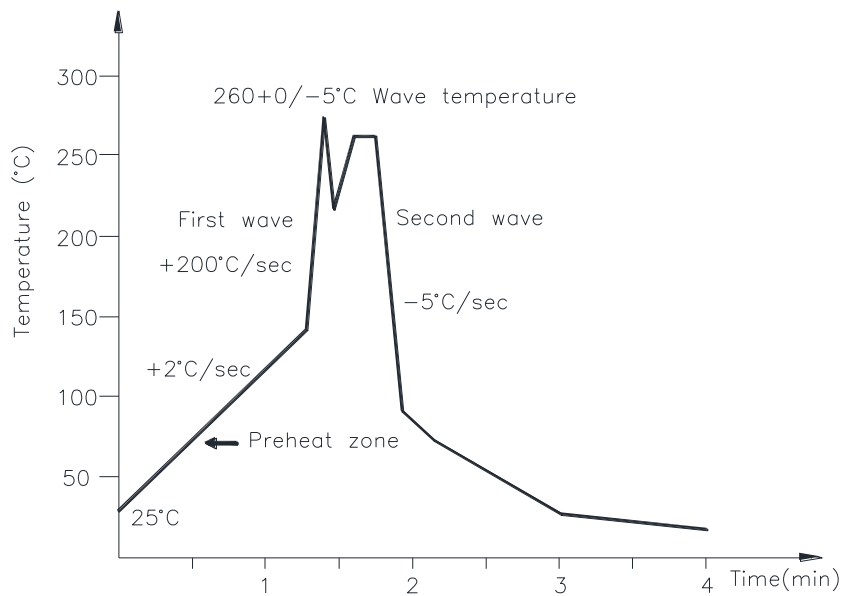

7.3 Hand soldering by soldering iron

Allow single lead soldering in every single process. One time soldering is recommended.

Temperature: $380 \pm 0 / -5^{\circ}\text{C}$

Time: 3 sec max.

**Photocoupler
LTV-4506 series**

8. NAMING RULE

Part Number Options
LTV-4506
LTV-4506M
LTV-4506S-TA
LTV-4506S-TA1
LTV4506-V
LTV4506M-V
LTV4506STA-V
LTV4506STA1-V

Definition of Suffix	Remark
"4506"	LiteOn model name
"No Suffix"	Dual-in-Line package clearance distance 9 mm typical
"M"	Wide lead spacing package clearance distance 9 mm typical
"S"	Surface mounting package clearance distance 8 mm typical
"TA"	Pin 1 location at lower right of the tape
"TA1"	Pin 1 location at upper left of the tape

9. NOTES

- LiteOn is continually improving the quality, reliability, function or design and LiteOn reserves the right to make changes without further notices.
- The products shown in this publication are designed for the general use in electronic applications such as office automation equipment, communications devices, audio/visual equipment, electrical application and instrumentation.
- For equipment/devices where high reliability or safety is required, such as space applications, nuclear power control equipment, medical equipment, etc, please contact our sales representatives.
- When requiring a device for any "specific" application, please contact our sales in advice.
- If there are any questions about the contents of this publication, please contact us at your convenience.
- The contents described herein are subject to change without prior notice.
- Immerge unit's body in solder paste is not recommended.